



FOR OFFICIAL USE ONLY

SEPTAGE TREATMENT FOR BHUBANESWAR CITY



June – 2016

Detailed Project Report on Design, Construction, Operation and Maintenance of Septage Treatment System

Prepared under AMRUT Mission Guidelines and SAAP – 2015-16,
for Bhubaneswar City, State capital of Odisha.

Orissa Water Supply and Sewerage Board

CONTENT

| | Page |
|---|-------------|
| <u>Part – I, Design Report</u> | |
| 1. Introduction | 2 |
| 2. Project Requirement | 2 |
| 3. Project area and demand projection | 3 |
| 4. Design period | 4 |
| 5. Determination of plant capacity | 4 |
| 6. Selection of process and review of technology options | 6 |
| 7. Facility design of treatment components | 7-43 |
| 8. Component dimensioning | 44 |
| 9. Structural Design of major components | 47-52 |
| <u>Part – II, Cost Estimates</u> | |
| 1. Economic aspects of the project | 53-55 |
| 2. Cost of main components | 56-63 |
| 3. S/R on major items | 64-82 |
| <u>Part – III, Operation and Maintenance</u> | |
| 1. O&M Requirement | 83-88 |
| 2. Manpower requirement | 89 |
| 3. Annual O&M cost | 89 |
| <u>Part – IV, GA and component drawings</u> | |
| 1. General Layout | 90 |
| 2. Component drawings | 91 |
| <u>Part – V, Bid document and contract</u> | |
| 1. Scope of work | 104 |
| 2. General terms and conditions | 156 |
| 3. Form of contract | 185 |
| <u>Appendix</u> | |
| 1. Test report on Septage characteristics (copies of test report) | |

INTRODUCTION

Atal Mission for Rejuvenation and Urban Transformation, in short, AMRUT, was launched by the Ministry of Urban Development, Govt. of India in June 2015. The objective of this new initiative is to ensure availability of basic amenities to the urbanites for improvement of quality of life. Special target groups under the mission have been the poor, disadvantaged and marginalised groups dwelling in the urban conglomerates. The basic objectives of the Mission are; (i) ensure that every household has access to a tap with assured supply of water and a sewerage connection, (ii) increase the amenity value of cities by developing greenery and well maintained open spaces (e.g. parks), (iii) reduce pollution by switching to public transport or constructing facilities for non-motorized transport (e.g. walking and cycling). The mission goals have been targeted by end of 2019-20. In order to prepare a state annual action plan (SAAP) the basic requirement is the service level improvement plan (SLIP) which shall be prepared by each of the ULBs in order to take following strategic steps in fulfilling the bare bones of AMRUT; (1) Assess the service level gap, (2) Bridge the gap, (3) Examine alternatives, (4) Estimate the cost, (5) Prioritize, (6) Out-of-box thinking, (7) Conditionalities, (8) Resilience (9) Financing and (10) Reforms.

Out of the five prioritized sectors under AMRUT, sewerage and septage management comes under priority number two. In Odisha, this sector is currently in infant stage. Only one conventional sewerage system has been established in Puri Town of 15 mld capacity aerated lagoon as the STP and with 130 kms of sewer network. The scenario in the State capital of Bhubaneswar and the historical city of Cuttack is that the conventional systems are under construction. These sewerage projects are per se slow going due to various technical reasons. These are also cost intensive i.e. around ₹15000 to 25000 per capita which has been discouraging in so far as the capital investment is concerned. As per the policy of the State, the conventional system shall be provided to the five municipal corporations. In the rest of the ULBs, the management of septage i.e. collection, transportation and treatment of faecal sludge shall be carried out which will be comparatively cheaper and also effective option for disposal of human excreta and wastewater. Also in case of municipal corporations, in the peri-urban localities, where the sewer network is not in the offing, septage management shall also be practised. Accordingly, the action plan for 2015-16 was prepared wherein 5 ULBs were selected for intervention. They are, Bhubaneswar, Cuttack, Sambalpur, Rourkela and Baripada. This report has been prepared for Bhubaneswar Municipal Corporation which is in addition to the sewerage project coming up in Bhubaneswar. However, the number and capacity of the septage treatment plant may increase depending upon the population growth and effective collection and hauling network of septage through Govt. or PPP mode of operation. Though the approach is currently top down, the ultimate objective of the project is to have a participatory approach with community involvement in the collection, hauling, treatment and end use of the septage thus moving towards a hygienic and cleaner environment.

SEPTAGE PROJECT DEVELOPMENT PLAN FOR BHUBANESWAR CITY:

Bhubaneswar, the City of temples and the capital of Orissa State, is strategically located at about 50 km from the east coast of India between Kolkata and Chennai, the two metropolitan of the Country. The City is well connected by road and railway network to other urban centres in the state and neighbouring states. NH-5 (Kolkata-Chennai) and NH-203 (Bhubaneswar-Puri) traverse through the City. Bhubaneswar is directly connected by rail network with Kolkata, Puri, Chennai, Delhi, Mumbai, Bangalore, Guwahati, Hyderabad and Thiruvanthapuram. The City is also connected by air with all four major metropolitan cities apart from other cities like Vishakhapatnam, Hyderabad and Raipur. Geographically the City lies between 85044' to 85055' E Longitude and 20012' to 20015' N Latitude and has an average elevation of 45.0 m above MSL, levels varying from a low of 7m above MSL to a high of 75m above MSL. The City is administered by Bhubaneswar Municipal Corporation (BMC) and the administrative jurisdiction of BMC extends over 135 km². The City is bounded on the north by villages of Daruthenga, Raghunathpur, kalarahanga, Injena, Rokata, Krushna, Saranapur, Barimunda, Kacharamala; on the eastern side by villages of Janmeyapur, Bhimpur, Jaganathpur, Saleswar, Andilo, kuakhai river, Koradakanta, Kesura, Bankual, Basuaghai, Raghunathpur; on the southern side Daya river and villages Kukudaghai, Mohanpur, Dihapur, Balabhadrapur, Erabanga, Kochilaput, Bahadalpur, Sarankantar, raysinghpur, Papada, Sankarpur, Kaikarapur; and on western side by villages Nuagan, Malipada, Andharua, Jaganathprasada, Sundarpur and Patharagadia.

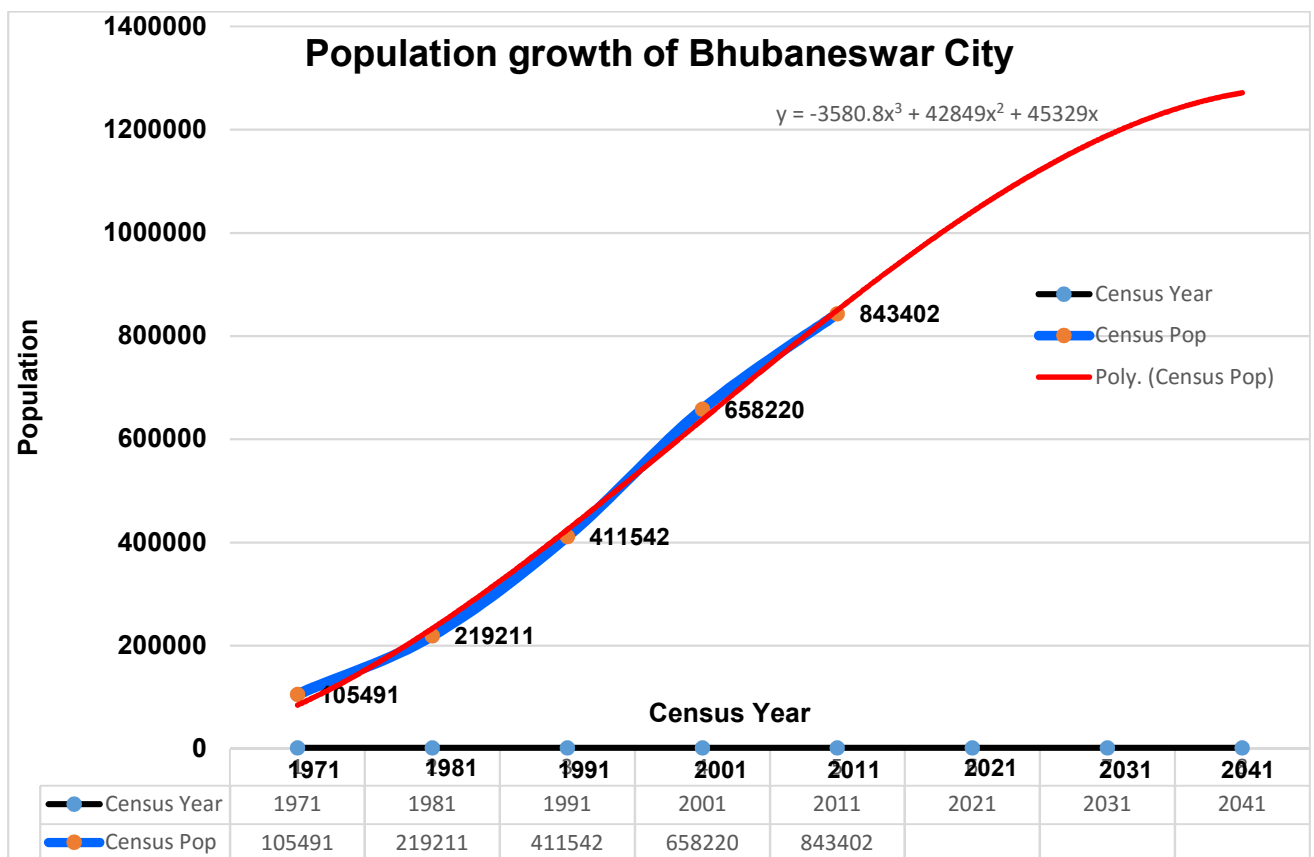

Fig: 1 Projected Population of Bhubaneswar City for the design period of 20 years starting from 2017

The plotted graph with available data shows the ‘S’ pattern. This indicates that the urban population within the defined area is approaching a saturation unless the municipal boundary sprawls further. A polynomial curve fit of 3rd order trend line was found to be the most appropriate considering the growth pattern in the last five decades. The observed decadal growth rate is;

- 71-81: $(219211 - 105491) / 105491 = 1.078$ i.e. 107.80%
- 81-91: $(411542 - 219211) / 219211 = 0.8773$ i.e. 87.73%
- 91-01: $(658220 - 411542) / 411542 = 0.5993$ i.e. 59.93%
- 01-11: $(843402 - 658220) / 658220 = 0.2813$ i.e. 28.13%

The trend line analysis provides a growth equation: $y (\text{pop}) = -3540.8x^3 + 42849x^2 + 45329x$ on a polynomial 3rd order scale. Using this equation, the projected population for next two decades are as follows subject to no addition to the current municipal boundary and with the assumption that there shall be no major infrastructural development within the municipal boundary limit triggering an exodus / high rate of migration from the countryside or from other urban localities.

$$2021: -3540.8 \times 6^3 + 42849 \times 6^2 + 45329 \times 6 = 10,49,725$$

$$2031: -3540.8 \times 7^3 + 42849 \times 7^2 + 45329 \times 7 = 12,02,410$$

$$2041: -3540.8 \times 8^3 + 42849 \times 8^2 + 45329 \times 8 = 12,92,078$$

The predicted average growth rate for the decades up to 2041 works out to 11.03% subject to the condition that no additional areas are included under the municipal limits. This is somewhat lesser than the national average of around 23% on a national average. Looking in to the growth especially in peri-urban areas and the limitations of coverage in peri-urban localities and slums, a 20% projected population for the design may be safely considered.

DESIGN PERIOD:

The plant design period is considered as 20 years since the service life of all major structural components shall a lifecycle period of 20 years. However, in order to reduce the capital expenditure, the capacity can be phased by 10 years each so that a second system is built after 10 years of service of the initial one.

Considering the year of implementation as 2016, the population to be served at the beginning i.e. 2017, after 10 years shall have to be estimated. For the next 10 years depending upon the actual growth pattern of the population, development of the on-site sanitation system within the municipal boundaries, growth of commercial and other institutions, who can contribute to the net demand shall have to be worked out before the end of the service period. In other words, full capacity utilisation of the first plant setup is to be achieved and thereafter capacity augmentation can be made with an appropriate modification of the facilities. Hence, in this analysis a demand period of 10 years and a service period of 20 years at full capacity after 10 years has been considered.

The projected population for the year 2017 using the above relation comes to 9,56,391 and population at the end of the period 2027 and 2037 grows to 11,32,617 and 12,56,449 respectively. Population to be considered in 2017, therefore, will be $956391 \times 0.2 = 1,91,278$

DETERMINATION OF PLANT CAPACITY:

Plant capacity is dependent upon the volume of sludge that is likely to be produced during the design period. The initial plant loading shall be based on the population contribution at the beginning i.e. during the year 2017 and shall increase @ 1.1% annually may be considered to project the capacity requirement.

The design flow can be determined in two different considerations. One is based on the on-site system that is actually existing and likely to be constructed through enforcement of pollution control law / rule with regard to discharge of sewage / wastewater to open environment by the households. The other one is based on the contribution directly by the population. In any case the demand or generation of sludge shall remain highly fluctuating throughout the service period of the facility. Similarly, collection

of the entire faecal sludge or septage that is generated may not be possible due to difficulty in approach, unwillingness of the housekeeper or badly designed on-site system. Therefore, a reasonably accurate quantification of the sludge production may not be possible under the present scenario of growth trend in fringe areas of Bhubaneswar city. Based on observation in various projects undertaken worldwide certain logic has been developed as discussed in the literature review part of this DPR and this shall be applied in this case to determine, with a fair degree of accuracy, the volume of septage that is likely to be handled during the service period of the plant i.e. reaching the full capacity within 10 years and operating with the full capacity with an allowable over capacity for the rest 10 years of its effective service life.

Though the ultimate aim is to deliver all septage or faecal sludge that is produced, it is unrealistic to assume that all so produced shall be collected and transported initially to the SeTP for treatment. Hence a reasonable quantity is required to be derived. Under anaerobic digestion which the septage undergoes inside a septic tank decomposes and stabilisation further and gets compacted under its own weight. Various observations have reported sludge production @ 30 l / capita / annum (Garg), 140 l / capita / annum (Metcalf & Eddy). Also as reported by Sasse, the sludge production can be in a range of 360 to 500 litres per capita per annum. Considering reduction in volume due to primary treatment through anaerobic digestion in septic tanks and also due to combination of comparatively fresh sludge from public toilets, a value of 150 litres per capita per annum may be reasonably accurate.

Sludge quantification:

1. Estimated per capita annual sludge generation as septage: **150 l / per capita / year**

2. Percentage of sludge collectible from septic tanks that are de-sludgable: the range is 60 to 80% (FSM toolbox)

3. Estimated annual septage generated: $0.6 \times (191278) \times 0.15 = 17215 \text{ m}^3$

4. Total considering 10% from commercial and institutional supply: 18937 m^3

5. Considering 6 days a week, for 280 working days, daily volume: 67.60 m^3

6. Considering a growth rate of 1.1% per annum, the sludge volume to be handled per day shall be:

| Year 0 | Year 1 | Year 2 | Year 3 | Year 4 | Year 5 | Year 6 | Year 7 | Year 8 | Year 9 |
|---------------------|---------------------|---------------------|---------------------|---------------------|---------------------|---------------------|---------------------|---------------------|---------------------|
| 67.6 m ³ | 68.3 m ³ | 69.1 m ³ | 69.9 m ³ | 70.6 m ³ | 71.4 m ³ | 72.2 m ³ | 73.0 m ³ | 73.8 m ³ | 74.6 m ³ |

We shall consider a daily design load of 75 m^3 at the end of 10 years' phase.

Treatment combination:

Inlet channel + Bar screen + Settling-Thickening Tank + Hybrid ABR + HF + M Pond + Unplanted Drying Bed
The above options have been selected considering the following;

- i. The combinations have been recommended by most of the authors who have carried out extensive work on Faecal Sludge Management.
- ii. Construction of components are simple and can be built using local material.
- iii. The question of further digestion anyway occurs in the thickening zones of settler and therefore, elaborate arrangement for only digestion for biogas is dispensed with.
- iv. No digester for gas production has been considered since, (i) gas is not envisaged for use, (ii) gas production is also low since it is septage which is partially digested and is of low strength, (iii) for above volume a large construction will be required as the minimum SRT shall be 25-30 days in hot climates that will lead to a large volume requirement, (iv) the construction and operation will require highly skilled people and as septage treatment is being taken up for the first time it will be inappropriate to include the same in the treatment process as there can be lack of skilled manpower for the purpose at ULB level, (v) there is heavy risk of fire hazard which can make the operation more complicated, (vi) due to high construction cost, (vi) high risk in operation and difficulty in removal of accumulated sludge has reported shutdown of many such plants (*Faecal Sludge Management in developing countries – A Planning Manual by Martin Strauss et al, 2002*).

Inlet Channel:



Fig 2: A typical manual screen channel in the septage plant. (Source: Linda Strande)

A typical configuration of inlet channel is shown above. Since the faecal sludge / septage shall be discharged from a cesspool emptier truck, a receiving pit with an inlet channel is required for offloading the septage to the settler cum equalizer tank for further treatment. The channel should have adequate hydraulic properties to carry the slurry / liquid sludge without deposition in the channel and the bar screen should be able to separate the floating solids from the sludge. The channels should be built in duplicate (two channels) for alternate cleaning and loading operations.

FACILITY DESIGN OF INLET CHANNEL (Hydraulic Capacity):

The inlet channel shall precede by one 1m x 1m size RCC header pit. The total depth of the channel shall be kept 1 m and length 3 m. A slope of 1% may be provided towards the bar screen inlet of the settling cum thickening tank. The length of channel may vary depending upon the loading point and the settling tank location.

Emptying time of one truck of 3000 litres capacity = 10 minutes

Discharge = 5 lps = 0.005 m³/s

A channel width of 300 mm is considered = b

Adopt Manning's 'n' = 0.014 (concrete with surface punning)

Using Manning's equation, the section factor $AR^{2/3} = n \times Q / \sqrt{S} = 0.014 \times 0.005 / \sqrt{(0.01)} = 0.007$

Considering a rectangular section: hydraulic radius = $(by / b + 2y)$

$AR^{2/3} = (by)^{5/3} / (b+2y)^{2/3} = 0.007$

⇒ $(0.3y)^{5/3} / (0.3 + 2y)^{2/3} = 0.007$, solving the equation for y,

⇒ y = 0.15 m or 150 mm = depth of flow (OK)

A_w = wetted area = 0.045 m², wetted perimeter, P_w = 0.6 m

V = velocity of flow in discharge channel = $(1/0.014) \times (0.045/0.6)^{0.67} \times (0.01)^{0.5}$

⇒ **1.26 m/sec > 0.8 m/sec (OK)**

Bar Screen:

A course bar screen made of stainless steel of SS304 grade with 20 mm spacing shall be provided vertically supported by channel section. The screen shall be placed in sludge receiving chamber of 1.5 m x 1.5 m plan facing the sludge channel.

Settling and thickening Tank:

(A first principle description has been made considering that any non-professionals will find it easy to understand)(Faecal Sludge Management – Systems Approach for Implementation and Operation by Linda Strande, et al, 2014, IWA Publication.)

Design and Operational principles of settling and thickening tanks:

Settling-thickening tanks are used to achieve separation of the liquid and solid fractions of faecal sludge / septage. They were first developed for primary wastewater treatment, and for clarification following secondary wastewater treatment, and it is the same mechanism for solids-liquid separation as that employed in septic tanks. Settling-thickening tanks for FS / septage treatment are rectangular tanks, where FS is discharged into an inlet at the top of one side and the supernatant exits through an outlet situated at the opposite side, while settled solids are retained at the bottom of the tank, and scum floats on the surface (Figure 3). During the retention time, the heavier particles settle out and thicken at the bottom of the tank as a result of gravitational forces. Lighter particles, such as fats, oils and grease, float to the top of the tank. As solids are collected at the bottom of the tank, the liquid supernatant is discharged through the outlet. Quiescent hydraulic flows are required, as the designed rates of settling, thickening and flotation will not occur with turbulent flows. Baffles can be used to help avoid turbulence at the inflow, and to separate the scum and thickened sludge layers from the supernatant.

Following settling-thickening, the liquid and solid fractions of FS or septage require further treatment depending on their final fate, as the liquid and solids streams are still high in pathogens, and the sludge has not yet been stabilised or fully dewatered. Settling-thickening tanks can be used in any climate, but are especially beneficial when treating FS or septage with a relatively low solids concentration, and/or in temperate or rainy climates. This is an important consideration in urban locations where space is limited, as it can reduce the required area of subsequent treatment steps. For instance, achieving solids-liquid separation in settling-thickening tanks prior to dewatering with drying beds reduces the required treatment area (footprint) for drying beds.

When using settling-thickening tanks there should be at least two parallel streams to allow for an entire operational cycle of loading, maintenance and sludge removal. For increased sludge compaction and ease of operations and maintenance, tanks should not be loaded during compaction, if the sludge is left to thicken at the bottom of the tank, or during the desludging period, when the supernatant is drained and the scum and thickened sludge are removed. Tanks are usually operated with loading periods ranging from one week to one month, depending on the tank volume. When operated in parallel, each tank is only loaded 50% of the time.

In most existing implementations in low-income countries, the sludge removal is done with backhoes / excavator, pumps if the sludge is not too thick to pump, or strong vacuum trucks. On the other hand, in wastewater treatment plants clarifiers typically include mechanical devices to remove the settled sludge from the tank.

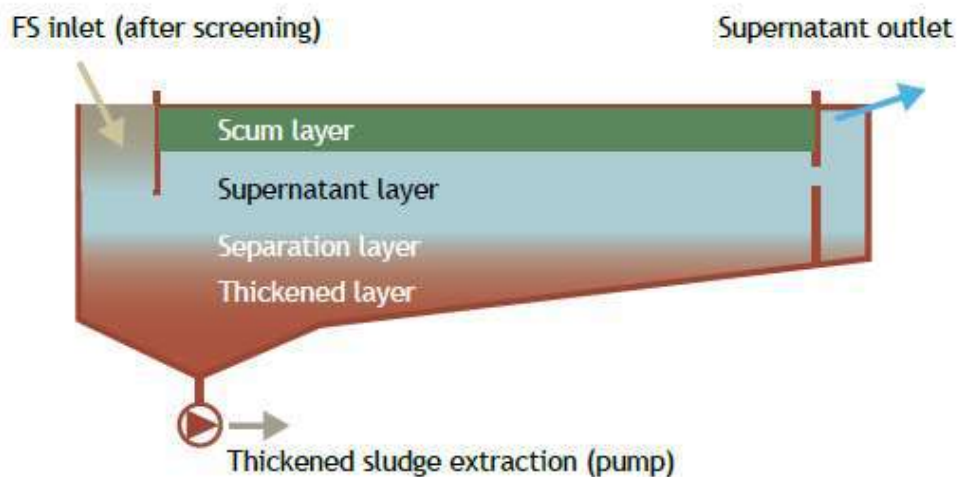

Figure 3: Schematic of the zones in a settling-thickening tank. (source: Magalie Bassan *et al.*)

The system subsumes three processes i.e. settling, thickening and floatation. Though anaerobic digestion also takes place but the same is not included as a treatment goal since it can hinder solid-liquid separation due to gas bubbles produced under anaerobic digestion process.

Settling mechanism:

In settling-thickening tanks the suspended solid (SS) particles that are heavier than water settle out in the bottom of the tank through gravitational sedimentation. The types of settling that occur are:

- discrete, where particles settle independently of each other;
- flocculent, where accelerated settling due to aggregation occurs; and
- hindered, where settling is reduced due to the high concentration of particles (Ramalho, 1977).

Discrete and flocculent settling happen rapidly in the tank. Hindered settling occurs above the layer of sludge that accumulates at the bottom of the tank, where the suspended solids concentration is higher. These combined processes result in a reduction of the solids concentration in the supernatant, and an accumulation of solids at the bottom of the tank.

Particles with a greater density settle faster than particles with lower densities. Based on the fundamentals of settling the distribution of types and shapes of particles in FS (and their respective settling velocities) could theoretically be used to design settling-thickening tanks. Although this theory is important in understanding the design of settling-thickening tanks, the reality is that when designing a settling tank, empirical values are determined and used for the design based on the characteristics of the FS in specific conditions.

The theoretical settling velocity of a particle is given by Equation 20. It is defined by the velocity attained by a particle settling in the tank as the gravitational strength overcomes the buoyancy and drag force that retain the particle in the top layer of the tank.

Equation 1: $V_c = [(4/3) \cdot g (\rho_s - \rho) d / C_d \rho]^{1/2}$

Where:

V_c = final settling velocity of the particle (m/h)

g = gravitational acceleration (m/s^2)

ρ_s = particle density (g/L)

ρ = fluid density (g/L)

d = particle diameter (m)

C_d = drag coefficient

The critical settling velocity, V_c , is selected based on the quantum of solids that are to be removed. Theoretically, if the flow is laminar (i.e. not turbulent) and there is no shortcutting of the hydraulic flow in the tank, all the particles with a velocity greater than V_c will be removed. This allows the tank to be designed based on the percentage of desired particle removal in the settled sludge. As the flow in the tank is lengthwise, the length has to be designed to be long enough to ensure that particles with V_c have adequate time to settle out below the level of the outlet. Particles with $V_c < V_{c0}$ will not have time to settle out, and will remain suspended in the effluent (as shown in Figure 4). Selection of V_c for actual design purposes is discussed in paras to follow.

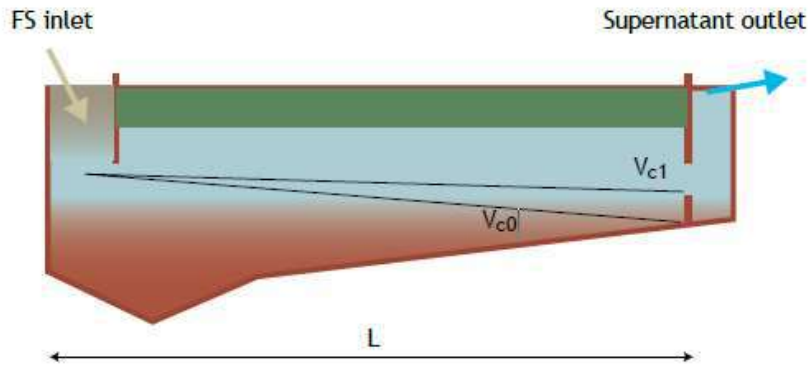

Figure 4: Schematic of the final settling velocity (V_c) needed for a particle to settle in a tank of length L . (source: Magalie Bassan *et al.*)

Thickening

Particles that accumulate at the bottom of the tank are further compressed through the process of thickening. The settled particles are compressed due to the weight of other particles pressing down on them, and water is squeezed out, effectively increasing the concentration of the total solids. This happens as a result of gravity, when the concentration of SS is high and inter-particle strengths hinder the individual movement of particles. Allowing room in the tank for sludge storage as it settles and accumulates is an important consideration in the design of tanks, because as sludge accumulates, it effectively reduces the depth of the tank available for settling. This is also important in designing the ongoing operations and maintenance, and schedule for sludge removal.

Flotation

The process has already been described in brevity at page 8 under fundamental mechanism. It is repeated here to maintain the flow of description. As stated earlier, similar to the settling and thickening mechanisms, the influence of gravitational strength due to density differences explains flotation. Buoyancy is the upward force from the density of the fluid. For particles that float, the buoyancy is greater than the gravitational force on the particle. Hydrophobic particles such as fats, oils and greases, and particles with a lower density than water are raised to the top surface of the tank by flotation. Some particles are also raised to the surface by gas bubbles resulting from anaerobic digestion. This layer that accumulates at the top of the tank is referred to as the scum layer.

Anaerobic digestion

Anaerobic digestion also occurs in settling-thickening tanks, mainly in the thickened layer. The level of digestion depends on the degree of the initial stabilisation of FS / septage, the temperature, and on the retention time inside the tank. This process degrades a part of the organic matter and generates gasses. Operational experience has shown that fresh FS that is not stabilised (e.g. from public toilets that are emptied frequently) does not settle well. This is because anaerobic digestion of fresh FS

contributes to an increased up-flow from gas bubbles, and FS that is not stabilised also contains more bound water. Thus, stabilised FS, especially the septage i.e. sludge from septic tanks and/or FS that is a mixture of stabilised and fresh sludge are more appropriate for treatment in settling-thickening tanks (Heinss *et al.*, 1998; Vonwiller, 2007).

Solids-liquid zones

The interactions of these fundamental mechanisms result in the separation of the FS into four layers, as illustrated in Figure 6.1 (Heinss *et al.*, 1998; Metcalf and Eddy, 2003):

- A layer of thickened sludge at the bottom. The solid concentration is higher at the bottom than at the top of this layer.
- A separation layer between the thickened layer and the supernatant, as the transition between these is not immediate. Hindered settling occurs mainly in the separation layer, where the settled sludge is not completely thickened. Particles in the separation layer can be more easily washed out with the supernatant than particles in the thickened layer.
- A supernatant layer between the separation layer and the scum layer. This consists of the liquid fraction and the particles that do not settle out or float to the surface.
- A layer of scum at the top of the tank. This consists of the floating organic and non-organic matter, the fats, oils, and greases contained in FS, as well as particles that have been raised up by gas up-flow.

The tank design is based on the estimated volume of FS, and the resulting supernatant flow, and production of scum and thickened sludge layers. An adequate design needs to include regular and efficient removal of the scum and thickened sludge, which needs to be considered to optimise the solids-liquid separation. These design aspects are discussed below, and examples are provided in the case studies and the design example.

Laboratory tests and faecal sludge characteristics influencing the design

A good understanding of site specific FS characteristics is required in order to determine the tank surface and the volume of the scum, supernatant, separation, and thickened sludge layers. determining an accurate value for influent loading of FS can be challenging depending on the local infrastructure and existing management system. The design loading needs to take into account that FS quantities and characteristics can also vary seasonally. An empirical estimation of settling ability for the specific FS for which the tank is being designed for, needs to be determined for adequacy in the design of the tank. Preliminary laboratory analysis should be conducted on the FS that is to be treated, especially in terms of settling ability, thickening ability, potential for scum accumulation and SS concentration (Strauss *et al.*, 2000). It is important to ensure that the FS used for these tests is that which will actually be treated. For example, if there is an existing network of collection and transport companies with vacuum trucks, sludge should be sampled from the trucks as this is what will be discharged at the treatment plant.



Figure 5: Imhoff cones being used in analyses of sludge volume index (source: SANDEC).

The sludge volume index (SVI) is a laboratory method to empirically determine the settling ability of sludge based on the amount of suspended solids that settle out during a specified amount of time. To determine the SVI, first the suspended solids content of FS is determined, and then a graduated Imhoff cone is filled with the FS sample that is left to settle (see Figure 6.4). After 30-60 minutes, the volume occupied by the settled FS is recorded in mL/L. The SVI is then calculated by dividing the volume of settled FS by the SS concentration (in g/L), which gives the volume of settled sludge per gram of solids. The Imhoff tests do not provide exact estimates of the depth of the thickened layer, as they are batch tests and not continuous loading as in a settling-thickening tank. Imhoff cones with volumes greater than one litre provide a more representative result as the wall effect is reduced (Heinss *et al.*, 1999).

Based on experiences in the design of settling-thickening tanks for wastewater treatment plants, wastewater sludge with a SVI of less than 100 (mL/g SS) achieves good solids-liquid separation in settling-thickening tanks. Measurements with FS in Accra, Ghana and Dakar, Senegal showed that FS had a good settling ability and thickening ability with SVI of 30-80 mL/g (Heinss *et al.*, 1998), and the personal experience of Dodane). SVI tests conducted in Dakar, Senegal (Africa) showed that FS settled rapidly during the first 20 minutes, after which more thickening occurred and continued for 100 minutes (Badji *et al.*, 2011).

Tank surface and length:

The length of the tank needs to be sufficient and have adequate hydraulic distribution, to ensure that the entire tank surface area is used, and that particles have enough time to settle. The surface area of the settling-thickening tank can be calculated as shown in Equation 2, based on the up-flow velocity (V_u) and the influent flow (Q_p) (Metcalf and Eddy, 2003).

Equation 2: $S = Q_p / V_u$

Where:

S = surface of the tank (m²)

Q_p = influent peak flow (m³/h)

V_u = up-flow velocity (m/h)

Q_p = Q . C_p/h,

Where:

Q = mean daily influent flow

C_p = peak coefficient

h = number of operating hours of the treatment plant (influent is only received during operating hours)

The up-flow velocity (V_u) is defined as “the settling velocity of a particle that settles through a distance exactly equal to the effective depth of the tank during the theoretical detention period” (Ramalho, 1977). It is used to calculate the acceptable inflow that will allow for particles with the defined settling velocity to settle out. Particles with a settling velocity slower than V_u will be washed out with the supernatant. A design value is selected for the desired percentage of suspended solids removal, and then the design up-flow velocity is selected to be equal to the final settling velocity of the lightest particles that will settle in the tank. For example, as shown in Figure 3, $V_u = V_{c0} > V_{c1}$. Thus, for a given FS influent, the up-flow velocity in a tank surface corresponds to the removal of a given percentage of suspended solids.

The peak coefficient is calculated by observation of when the greatest volumes of trucks are discharging at the FSTP / SeTP. For example, in Dakar, (Senegal, Africa) the peak period was observed to be 11:00 because trucks have their busiest emptying periods during the morning, and was calculated to be 1.6 times higher than the average.

Now, V_u can be estimated based on SVI values. Despite the limits of the theoretical calculation for design purposes, methods and calculations to link SVI and V_u have been developed based on long-term experiences in activated sludge treatment (Pujol *et al.*, 1990). However, this type of empirical knowledge does not yet exist for FS. $V_u = 0.5$ m/h could be used for rectangular settling tanks treating FS that have a SVI less than 100 (Megalie Bassan and Pierre-Henri Dodane). Once the surface area has been calculated, the length to width ratio needs to be selected. For example, (Heinss *et al.*, 1998) recommend a width to length ratio between 1:10 to 1:5. The lower the selected final settling velocity, the longer the tank needs to be, and the more particles that will settle out.

Tank volume

Once the surface area of the tank has been determined, the volume can be calculated, considering the depth of the four layers described in Figure 3. It is necessary to plan for the reduction in depth that will occur due to the accumulation of scum and thickened sludge, which will result in solids washed out with the supernatant, if underestimated.

Based on field observations of settling-thickening tanks in Accra and Dakar (Heinss *et al.*, 1998), the following values are recommended for designing tanks for FS / septage with similar characteristics:

- scum zone: 0.4 m (with 1 week loading, 1 weeks' compaction and cleaning) to 0.8 m (with 4 weeks loading and 4 weeks' compaction and cleaning);
- supernatant zone: 0.5 m; and
- separation zone: 0.5 m.

The depth of the thickened sludge zone needs to be calculated given the expected load inflow and the concentration of the thickened sludge (C_t). The design of a sufficient storage volume for the thickened sludge is crucial to avoid outflow of settled sludge during one operating cycle. Therefore, the expected operating cycle duration (i.e. loading, compaction and sludge removal) and methods for scum and thickened sludge removal need to be defined in the first place. The volume of the thickened sludge storage zone (V_t) can be calculated as shown in Equation 2 (Metcalf and Eddy, 2003).

Equation 3: $V_t = Q.C_i.e.N / C_t$

Where:

V_t = volume of thickened sludge storage zone (m³)

Q = mean FS daily inlet flow (m³/day).

C_i = suspended solids mean concentration of FS load (g/L)

e = expected settling efficiency (= proportion of suspended solids separated, as %)

N = duration of the FS load for one cycle in days

C_t = suspended solids mean concentration of thickened sludge after the loading period (g/L)

The mean daily flow is used for the sludge accumulation estimate, but the peak flow is used for the tank surface and length design to ensure settling is achieved under all the expected operating conditions. The volume of the thickening zone is based on the expected settling of FS. It is not considered in the design, but longer storage times when the tanks are not loaded prior to sludge removal, result in increased thickening and compaction. In the field, average FS settling efficiencies of only about 60% have been observed, due to poor operation and maintenance and gas up-flow (Heinss *et al.*, 1998). However, it is recommended to use 80% to estimate the maximum efficiency.

Care must be taken to ensure a relatively accurate estimate of C_t . An overestimation will lead to an insufficient storage volume and to a reduced settling efficiency, as solids may be washed out without being able to settle. An underestimation will lead to the design of an unnecessarily large storage volume and increase in construction costs.

Table 1 presents examples of SS concentrations given the initial FS load and thickening duration.

| Place of measurement | Concentration at inlet (g SS/L) | Thickening duration (day) | Concentration in thickened zone (g SS/L) |
|----------------------|------------------------------------|------------------------------|---|
| Dakar, FSTP | 5 | 10 | 60-70 |
| Accra, FSTP | 15-20 | 9 | 60-85 |
| Accra, FSTP | 15-20 | 30 | >100 |
| Accra, FSTP | 15-20 | 50 | 140 |
| Accra, laboratory | 40 | 7 | 100 |

Table 1 Concentration of sludge in the thickening zone of settling tanks in Accra and Dakar (Source: Heinss *et al.*, 1998; Badji *et al.*, 2011)

Inlet and outlet configuration

Grit screening must be undertaken before the loading of FS into the settling-thickening tanks in order to facilitate maintenance (e.g. removal of coarse waste to avoid potential damage to pumps).

The inlet zone should allow for the uniform and quiescent distribution of the flow in the whole tank and avoid short-circuiting. Therefore, baffles are recommended to help disperse the energy of the inflow, and to reduce the turbulence in the tanks. (Heinss *et al.*, 1998) recommend locating the inlet zone near the deep end of tanks to improve the solids settling. The pumps for the extraction of the thickened sludge must be adapted to remove concentrated sludge. Easy access points should also be included to allow the sampling of sludge in these zones, and to ensure that easy repair of pumps is possible.

The supernatant outlet zone should be located under the scum layer and above the thickened sludge storage layer. Baffles are useful to avoid washout of the scum with the supernatant. To ensure an optimal hydraulic flow, the outlet channel can be extended along the width of the wall (Heinss *et al.*, 1998). It must be at the opposite side of the inlet zone. Outlets that are positioned near to the shallower side of the tank reduce the carry-over of the settled solids from the thickening layer.

Operation and Maintenance of Settling-thickening Tanks

At least two settling-thickening tanks should be operated alternately in parallel, in order to allow for sludge removal as tanks should not be loaded during this time. The loading of FS, and the compaction and removal of the thickened sludge and scum comprise the main phases of an operating cycle. These periods allow for the expected solids-liquid separation and thickening operations. While the tanks are not loaded, additional compaction occurs prior to the removal of thickened sludge and scum, due to the lack of hydraulic disturbance (Heinss *et al.*, 1998). During this time further solids-liquid separation occurs, and the SS concentration increases in the thickened sludge and scum.

Sludge and scum removal

The timing of the removal of sludge and scum as planned for in the design is essential to ensure that the settling-thickening tanks are functioning properly, and that there is adequate depth for the settling of particles, leading to a reduced solids-liquid separation.

If it is observed that a higher volume of thickened sludge has accumulated than what was designed for, this means that the solid load is higher than expected, and operations should be appropriately altered. Sludge removal typically lasts a few hours to a day following the compaction period. Once in operation, detailed monitoring can be done to optimise compaction and sludge removal times based on actual operating conditions.

The first step in sludge and scum removal is typically removal of the scum layer. The scum layer generally has a high solids concentration that cannot be easily pumped and can remain after the thickened sludge is removed, in which case it needs to be manually removed. If possible, scum can be removed with shovels from both sides of the tank when the tank is narrow enough for access, or by mechanical means such as vacuum trucks with strong pumps. Scum can also be removed manually or sucked by a vacuum tanker after emptying the tank. (as followed in the Camberene treatment plant, Senegal, Africa).

Secondly, the supernatant layer is frequently removed by pumping or by gravity (depending on the design). It can be pumped to the parallel settling-thickening tank or to the next step in the treatment chain. The thickened sludge can then be pumped or shovelled out of the tank after the supernatant has been removed. When a pump is used for extracting the thickened sludge, the supernatant layer does not need to be removed, as the supernatant layer can facilitate the pumping of thickened sludge as a pressure is maintained. As tanks are frequently over 2 m deep, adequate access for sludge removal (and for tank and pump cleaning) needs to be integrated into the design. The operator knows when it is time for sludge removal based on the loadings and times given in the design, and also by visual observation.

It is possible to design settling-thickening tanks with devices that continuously scrape and pump the thickened sludge out of the tanks, and remove the scum over the supernatant zone. These devices allow easier operation and increase the management flexibility, but increased operating and maintenance costs need to be taken into consideration. Also their use in DEWATS may not be viable considering energy requirement and operating cost of the plant.

Start-up period and seasonal variations:

As settling-thickening tanks rely mainly on physical processes, there is no special requirement for start-up periods. It is however useful to adjust the load time, assess the depths of the different zones and optimise the compaction time and sludge removal frequency. Seasonal variations of meteorological conditions and FS characteristics may influence the efficiency of the tanks. For example, loss of water through evaporation could increase the solids content of the scum. High temperatures may also increase the anaerobic digestion process, and therefore the height of the scum layer.

Performance of Settling-Thickening Tanks:

The most important consideration in the performance of settling-thickening tanks is the separation of the liquid and solid fractions. The efficiency of the key mechanisms to achieve this are discussed here.

Solids-liquid separation:

In the field, the mean settling efficiency of operating tanks and ponds is about 50-60% of SS in the settled volume. This efficiency can reach up to 80% where the tanks have been adequately designed and operated (Heinss *et al.*, 1999).

The concentration of the thickened sludge (C_t) achieved depends on the operating cycle duration and the initial FS characteristics (thickening ability), as presented in Table 1. Achieving 60 g SS/L in the thickened zone for a seven days' load period seems a reasonable estimate. In Accra, with an operating cycle of about eight weeks, (Heinss *et al.*, 1998) observed a total solid content of 150 g TS/L in the thickened layer.

The scum layer thickness and SS content depends mainly on the operating cycle duration, the FS characteristics and the evaporation process. (Heinss *et al.*, 1998) report a scum layer of 80 cm in settling-thickening tanks operated with cycles of 8 weeks. In the Dakar FSTP the observed scum layer had a depth of 10 to 20 cm after one week of loading.

Treatment performance

The main objective of settling-thickening tanks is solids-liquid separation, not stabilisation or pathogen reduction. Further treatment steps are required for both the thickened solids and supernatant. Dissolved organic matter, nutrients, and suspended particles will remain in the supernatant. Examples include 50% of influent COD in the settled sludge, and 50% in the supernatant (Badji *et al.*, 2011), and 10% influent BOD and 25% COD in the supernatant (Heinss, *et al.*, 1998). Total pathogen removal or inactivation is also negligible. Many larger pathogens such as Helminth eggs settle out, and the amounts that are partitioned in the solids will be correlated to SS removal efficiency. (Heinss *et al.*, 1998) observed that 50% of the total Helminth eggs were partitioned in the thickened sludge.

| | |
|--|---|
| Initial raw FS concentration: | $C_{i(TS)} = 7 \text{ g TS/L}$ $C_{i(SS)} = 5 \text{ g SS/L}$ |
| FS origin: | Mainly septic tanks (stabilised FS) |
| Total volatile solids percentage | < 70% |
| Influent flow: | $Q = 140 \text{ m}^3/\text{day}$ |
| FSTP opening time: | 7 h/day 5 days/week 52 weeks/year |
| Daily peak flow coefficient: | $C_p = 1.6$ (peak flow is often in the morning, after the first trucks rotation) |
| Concentration of thickened sludge (1 L Imhoff cones) | 60 g SS/L |
| Settling ability (1 L Imhoff cones) | Good (SVI = 23 << 100) |

Table 2 Results of preliminary studies to determine design parameters (Source: Pierre-Henri Dodane *et al.*);

Advantages and Constraints of Settling-Thickening Tanks

Settling-thickening tanks are efficient as a first treatment step as they rapidly achieve solids-liquid separation, they are relatively robust and resilient, and they reduce the volume of sludge for subsequent treatment steps.

Constraints of settling-thickening tanks include

- lack of experience operating with FS, and lack of empirical data and results on which to base designs on;
- settled sludge still has relatively high water content and requires further dewatering;
- the liquid fraction remains highly concentrated in SS and organics; and
- pathogen removal is not significant, and the end products of settling tanks therefore, cannot be discharged into water bodies or directly used in agriculture.

FACILITY DESIGN OF SETTLER CUM THICKENER:

Design considerations:

1. Faecal sludge origin: septic tank (stabilised FS)
2. The terminal settling velocity in the tank is taken as $V_c = 0.5$ m/hour based on SVI and experience.
3. The expected settling efficiency is taken as 80% of SS.
4. Two parallel tanks are designed to allow alternate cleaning and loading.
5. The loading of one week is considered to minimise anaerobic digestion and gas up-flow. This entails one tank is to be loaded one week out of every two weeks while the other one is being emptied in the same period of time. Hence the cycle of operation is two weeks.
6. A short compaction period of 2-3 days is considered before removal of thickened sludge which means that the thickened sludge is scheduled to be removed after every 10 days where the sludge is still sufficiently liquid for extraction through a sludge / slurry pump.
7. The daily peak co-efficient is considered as 1.6
8. The SeTP opening time is 8 hours a day and 5 days a week (N).
9. The operator has gained experience in wastewater treatment and therefore, the sludge pumping and tank cleaning is carried out correctly.
10. The initial SS concentration in the septage is taken as 5 g/litre
11. Sludge settling characteristic is good i.e. SVI <100
12. Concentration of thickened sludge, ' C_i ' is taken as 60 g SS / litre

Design calculation for dimensioning:

Peak flow, $Q_p = Q \cdot C_p / 8 = 75 \times 1.6 / 8 = 15$ m³/hour.

Surface area required, $S = Q_p / V_c = 15 / 0.5 = 30$ m², two tanks of 30 m² each is to be constructed.

Sludge quantity as SS, $M = Q \times C_i = 75 \times 5 = 375$ SS kg/day

Considering a settling efficiency of 80% as above,

Mass of thickened sludge, $M_t = 0.8 \times 375 = 300$ SS kg/day

Volume of thickened sludge, $V_t = M_t \times N / C_t = 300 \times 5 / 60 = 25 \text{ m}^3 / 10$ days

Tank dimension:

Width to length ratio may be adopted as 0.2, $5w^2 = 30$, $w = 2.5$ m, $l = 12.25$ m + 2 m for baffles

Zone depth: Scum = 0.4 m, Supernatant = 0.5 m, transition = 0.5 m

Thickening zone = $25/30 = 0.83$ m

Total SWD = $0.4 + 0.5 + 0.5 + 0.83 = 2.23$ m Say, 2.25 m

Tank dimension, $L = 14.5$ m, $B = 2.5$ m, SWD = (2.25 m + 0.3 FB)

Slope towards inlet = 2%, pump pit / pit for draw off pipe, 1m x 1m

Outlet baffle opening = 0.7 m below liquid surface and 1m above bottom at outlet.

One sludge pump shall be provided with 100% standby.

Sludge shall be discharged every 10 days from the tank. The volume to be discharged is 25 m^3

A pump suitable to discharge 25 m^3 of sludge on to a drying bed shall be required.

Treatment of liquid stream:

The treatment of liquid stream after sludge separation at the settler shall be carried out through DEWATS. The selected DEWATS components for the purpose of treatment are;

1. Anaerobic baffled reactor with provision of anaerobic filters,
2. Horizontal filter,

End use of effluent as well as the dried sludge shall depend on the demand. During the period when the demand has a possibility to grow, disposal through burial etc. can be explored. A detailed location survey as well as market survey will have to be conducted for the purpose. The possibility of co-composting with vegetable waste collected from the vegetable / fruits market should also be examined.

ANAEROBIC BAFFLED REACTOR DESIGN:

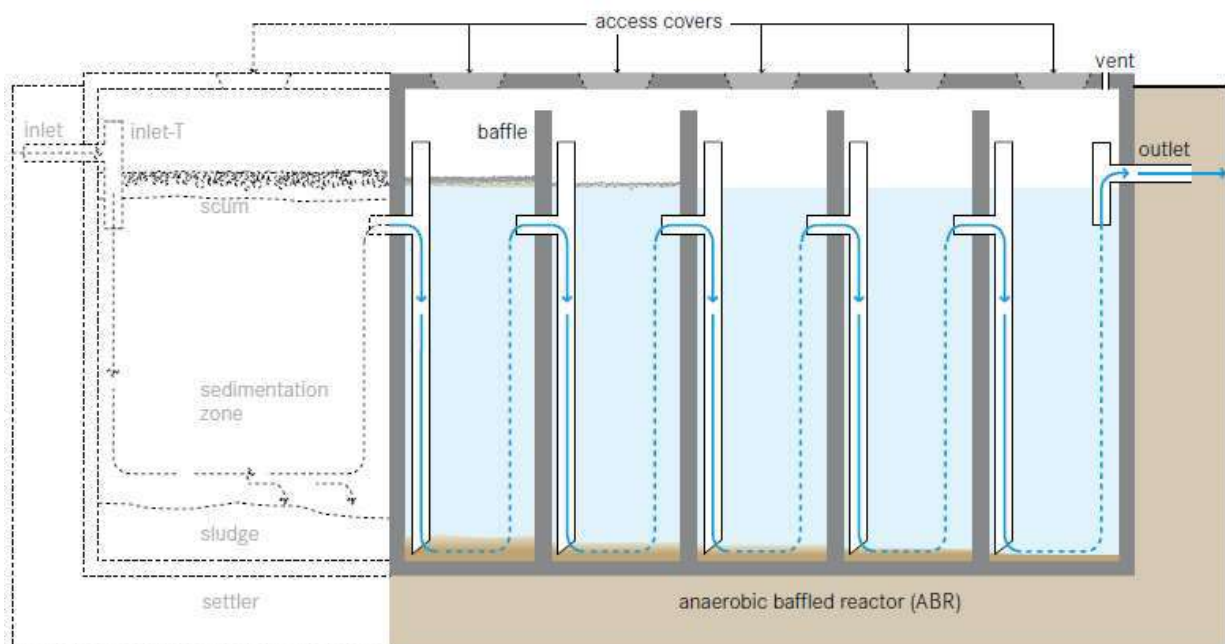

Figure 6: Anaerobic baffled Reactor (Source: Tilley *et al*, 2014).

The up-flow chambers provide enhanced removal and digestion of organic matter. BOD may be reduced by up to 90%, which is far superior to its removal in a conventional Septic Tank.

Design Considerations: The majority of settleable solids are removed in a sedimentation chamber in front of the actual ABR. Small-scale, stand-alone units typically have an integrated settling compartment, but primary sedimentation can also take place in a separate Settler or another preceding technology (e.g., existing Septic Tanks). Designs without a settling compartment are of particular interest for Septage Treatment plants that combine the ABR with another technology for primary settling, or where prefabricated, modular units are used. Typical inflows range from 2 to 200 m³ per day. Critical design parameters include a hydraulic retention time (HRT) between 48 to 72 hours, up-flow velocity of the wastewater in the range between 0.6 to 2 m/h and the number of up-flow chambers (3 to 6). The connection between the chambers can be designed either with vertical pipes or baffles. Accessibility to all chambers (through access ports) is necessary for maintenance. Usually, the biogas produced in an ABR through anaerobic digestion is not collected because of its insufficient amount. The tank should be vented to allow for controlled release of odorous and potentially harmful gases.

Appropriateness: This technology is easily adaptable and can be applied at the household level, in small neighbourhoods or even in bigger catchment areas. It is most appropriate where a relatively constant amount of black-water and greywater is generated. This technology is suitable for areas where land may be limited since the tank is most commonly installed underground and requires a small area. ABRs can be installed in every type of climate, although the efficiency is lower in colder climates. They are not efficient at removing nutrients and pathogens. The effluent usually requires further treatment.

Health Aspects/Acceptance: Under normal operating conditions, users do not come in contact with the influent or effluent. Effluent, scum and sludge must be handled with care as they contain high levels of pathogenic organisms. The effluent contains odorous compounds that may have to be removed in a further polishing step. Care should be taken to design and locate the facility such that odours do not bother community members.

Operation & Maintenance: An ABR requires a start-up period of several months to reach full treatment capacity since the slow growing anaerobic biomass first needs to be established in the reactor. To reduce start-up time, the ABR can be inoculated with anaerobic bacteria, e.g., by adding fresh cow dung or Septic Tank sludge. The added stock of active bacteria can then multiply and adapt to the incoming wastewater. Because of the delicate ecology, care should be taken not to discharge harsh chemicals into the ABR. Scum and sludge levels need to be monitored to ensure that the tank is functioning well. Process operation in general is not required, and maintenance is limited to the removal of accumulated sludge and scum every 1 to 3 years. This is best done using a Motorized

Emptying technology. The desludging frequency depends on the chosen pre-treatment steps, as well as on the design of the ABR. ABR tanks should be checked from time to time to ensure that they are watertight. ABRs when employed in treating the sludge supernatant may not require inoculation for start-up since the facility preceding the treatment in SeTP can provide the required inoculation.

Plus & Minus:

- + Resistant to organic and hydraulic shock loads
 - + No electrical energy is required
 - + Low operating costs
 - + Long service life
 - + High reduction of BOD
 - + Low sludge production; the sludge is stabilized
 - + Moderate area requirement (can be built underground)
-
- Requires expert design and construction
 - Low reduction of pathogens and nutrients
 - Effluent and sludge require further treatment and/or appropriate discharge

FACILITY DESIGN ANAEROBIC BAFFLED REACTOR:

Design Considerations:

1. The up-flow velocity shall remain below 2 m/hour.
2. The organic loading shall be below 3 Kg COD / m³. day
3. The HRT of the liquid fraction i.e. above sludge volume shall not be less than 8 hours.
4. Sludge storage volume should be provided @ 4 l/m³ BOD_{inflow} in the settler and 1.4 l/m³ BOD_{removed} in the upstream treatment facility i.e. settler cum thickener etc.
5. Minimum number of chambers should be four excluding the settler

Discharge from settler:

After the process of settling, the supernatant shall pass through an ABR. The volume of supernatant works out to around 90% of the influent volume.

The daily flow to the ABR = 0.9 x 75 = 67.5 m³/day

It is considered to have two tanks in parallel having a capacity to handle 2/3rd of the above flow in each of the installation. Hence flow to be considered to each installation = 0.67 x 67.5 = 45.22 Say, 45 m³/day. The SS concentration from settler supernatant is considered to be 2.2 g / litre or 2.2 Kg SS / m³. Expected COD removal efficiency shall be around 80%. The organic loading shall be taken as 3 Kg COD / m³.day since the supernatant from the settler is expected to have COD in the range of 20-40% of the septage inflow. The calculation of the dimension of the system has been shown in the spreadsheet in fig 16. A BOD₅ loading of 800 ppm has been considered as dissolved however, the total COD loading threshold has been taken as 3.0 Kg / m³.day. The curves taken for calculation of dimension of ABR and Horizontal Filter (Constructed Wetland) is reproduced below. Values in figures 7-12 recommended by Sasse, 1998, have been used in determining the capacity of the system. The spreadsheet proposed by Sasse, 1998, has been used to determine the dimensions of the ABR as shown in figure 13.

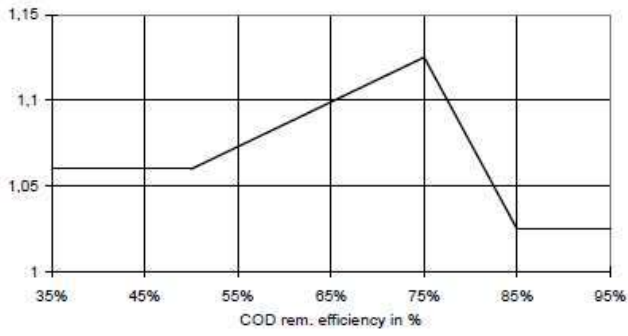

Fig 7: Simplified curve of ratio of efficiency of BOD removal to COD removal

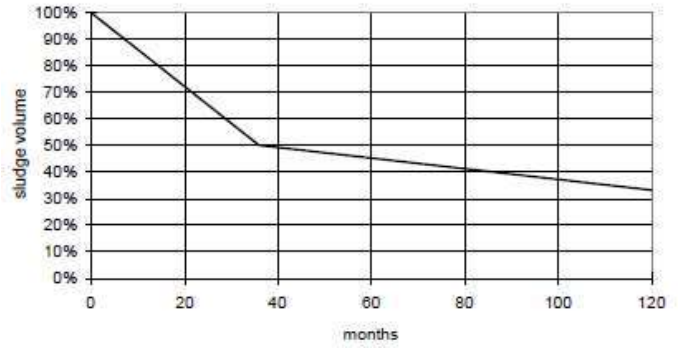

Fig 8: Reduction of sludge volume during storage

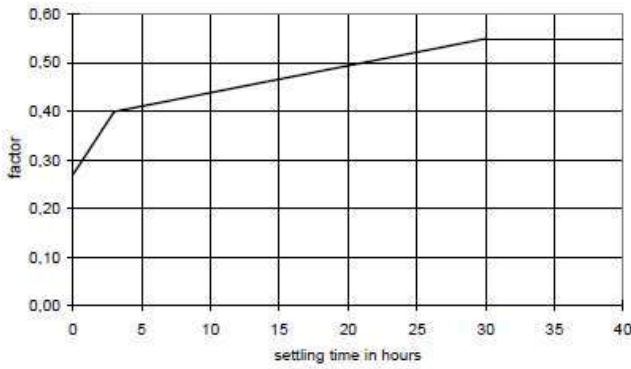

Fig 9: COD removal in settlers

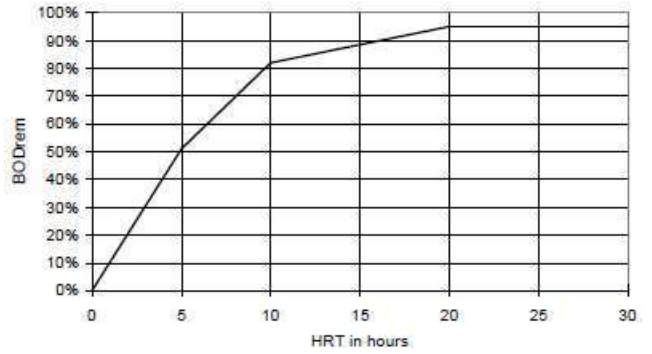

Fig 10: Baffled septic tank, BOD_{rem} in relation to HRT

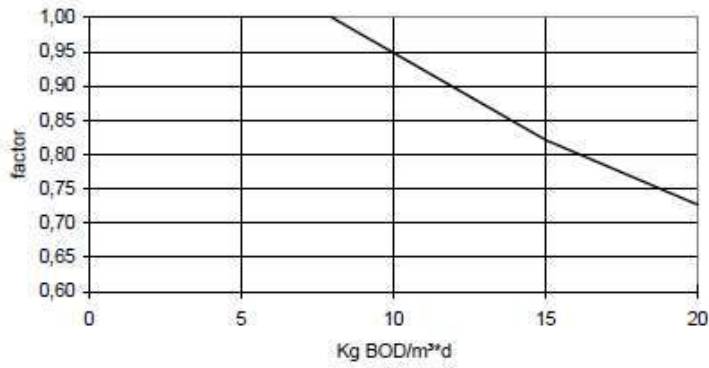

Fig 11: Baffled septic tank, BOD_{rem} in relation to organic load

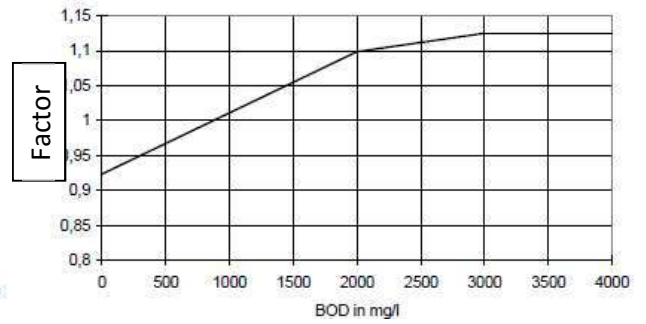

Fig 12: Baffled septic tank, BOD_{rem} in relation to wastewater strength

| GENERAL SPREADSHEET FOR BAFFLED REACTOR WITH INTEGRATED SETTLER | | | | | | | | | | | |
|---|-------------------------------------|--------------------------------|---|--|--------------------------|--------------------------|----------------------------------|---|------------------------------|--|-------|
| Daily Wastewater Flow | time of most wastewater flow | max peak flow per hour | COD inflow | BOD5 Inflow | COD/BOD ratio | Settleable COD/BOD ratio | lowest digester temp | de-sludging interval | HRT in settler | COD removal rate in settler | |
| avg | data | max. | data | data | Cal | data | data | data | data | result | |
| m ³ /day | hour | m ³ /hour | mg/l | mg/l | ratio | mg/l | °C | months | hour | % | |
| 45 | 8 | 6 | 2200 | 800 | 3 | 0.42 | 25 | 18 | 1.5 | 23% | |
| TREATMENT DATA | | | | | | | | | | | |
| BOD removal rate in settler | Inflow into baffled reactor | | COD/BOD ₅ ratio after settler | factors to calculate COD removal rate of baffled reactor | | | COD Remv, 25°, COD 1500 | Theoretical removal rate according to factors | COD removal rate baffle only | COD outflow | |
| Cal | COD | BOD ₅ | Cal | calculated according to graphs by Sasse, 1998 | | | Cal | Cal | Cal | | |
| % | mg/l | mg/l | number | f-overload | f-Strength | f-temp | f-HRT | % | % | mg/l | |
| 24% | 1699.5 | 607.08 | 2.80 | 1 | 0.971 | 1 | 1.02 | 99% | 92% | 134.47 | |
| 1.06 | < COD/BOD Removal Factor | | | | | | COD/BOD Removal Factor> | | 1.04 | | |
| Dimensions of Settler | | | | | | | Baffled septic tank | | | | |
| Total COD removal rate | Total BOD ₅ removal rate | BOD ₅ outflow | Inner measurements chosen according to volume | | Sludge accumulation rate | Volume of settler | length of settler | Max up-flow vel | No of up-flow chambers | Depth at outlet | |
| cal | cal | cal | width | depth | cal | cal | data | data | data | data | |
| % | % | mg/l | m | m | l/g COD | m ³ | m | m/h | no. | m | |
| 83% | 87% | 105.79 | 5 | 1.75 | 0.004 | 2.97 | 5 | 1 | 5 | 1.75 | |
| Dimensions of baffled septic tank | | | | | | | Status | | | | |
| Length of chambers <= half depth | | Area of single up flow chamber | Width of Chambers | | Actual up flow velocity | Width of downflow shaft | Actual volume of baffled reactor | Actual Total HRT | Org Load BOD ₅ | Biogas (70% CH ₄ , 50% dissolved) | |
| cal | | data | cal | data | cal | data | cal | cal | cal | cal | |
| m | | m | m | m | m/h | m | m ³ | h | kg/m ³ .day | m ³ /day | |
| 0.875 | | 0.875 | 5.625 | 6.43 | 5.00 | 1.29 | 0.30 | 51.41 | 26.11 | 1.594 | 23.24 |

Fig 13: Showing the Design dimensions of Anaerobic Baffled Reactor (Source: Sasse, 1998)

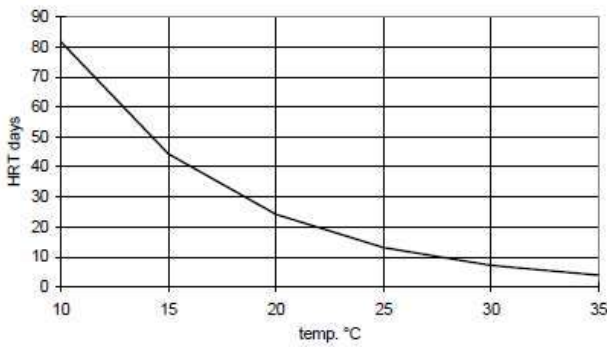

Fig 14: Planted gravel filter, 90% BOD rem.

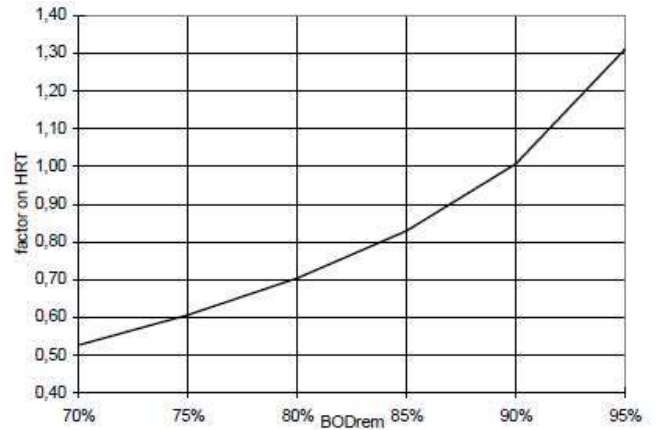

Fig 15: Planted gravel filter, 35% pore space; 25°C

DESIGN AND OPERATIONAL PRINCIPLES OF CONSTRUCTED WETLANDS

Sasse, 1998, describes regarding three basic treatment systems which may fall in the category of constructed wetlands. These are;

- the overland treatment system
- the vertical flow filter, and
- the horizontal flow filter.

For overland treatment the water is distributed on carefully contoured land by sprinklers. The system requires permanent attendance and maintenance. For that reason, it does not belong to DEWATS.

For vertical filter treatment the wastewater is distributed with the help of a dosing device on two or three filter beds which are charged alternately. Charging intervals must be strictly followed which makes the vertical filter less suitable for DEWATS.

The horizontal filter is simple by principle and requires almost no maintenance, however under the condition that it has been well designed and constructed. Design and construction requires a solid understanding of the treatment process and good knowledge of the filter medium that is to be used.

Constructed wetlands, especially sand and gravel filters, are by no means a simple technology, although they may look like part of nature. Before deciding on filter treatment, one should always consider the alternative of constructing wastewater ponds instead. Nonetheless, filter treatment has the great advantage of keeping the wastewater below ground. The horizontal and the vertical filter are two systems that are principally different. The horizontal filter is permanently soaked with water and operates partly aerobic (free oxygen present), partly anoxic (no free oxygen but nitrate -NO₃- present) and partly anaerobic (no free oxygen and no nitrate present). The vertical filter is charged in intervals (similar to a trickling filter) and functions predominantly aerobically. Although the vertical filter requires only about half the area of a horizontal filter and has better treatment qualities, only the horizontal filter is considered a DEWATS technology for the reason that it has no movable parts and does not require permanent operational control. Types of constructed wetlands based on above categorisation are illustrated below;

A free-water surface constructed wetland which comes under overland treatment system aims to replicate the naturally occurring processes of a natural wetland, marsh or swamp. As water slowly flows through the wetland, particles settle, pathogens are destroyed, and organisms and plants utilize the nutrients. This type of constructed wetland is commonly used as an advanced treatment after secondary or tertiary treatment processes.

FREE-WATER SURFACE CONSTRUCTED WETLAND

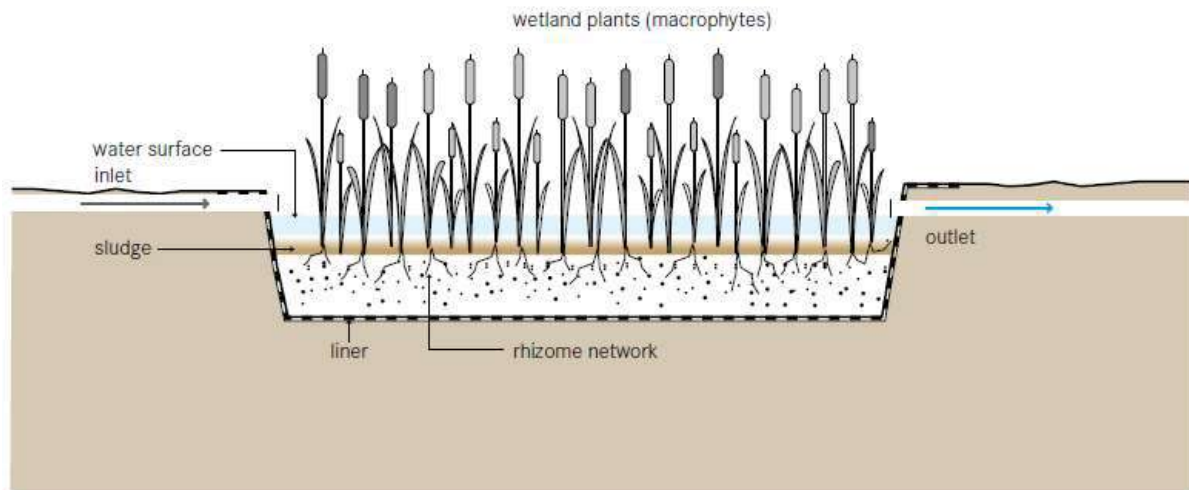

Figure 16: Free-water surface Constructed Wetland (Source: Tilley *et al*, 2014).

Unlike the Horizontal Subsurface Flow Constructed Wetland, the free-water surface constructed wetland allows water to flow above ground exposed to the atmosphere and to direct sunlight. As the water slowly flows through the wetland, simultaneous physical, chemical and biological processes filter solids, degrade organics and remove nutrients from the wastewater.

Raw black-water should be pre-treated to prevent the excess accumulation of solids and garbage. Once in the pond, the heavier sediment particles settle out, and this also removes the nutrients attached to them. Plants, and the communities of microorganisms that they support (on the stems and roots), take up nutrients like nitrogen and phosphorus. Chemical reactions may cause other elements to precipitate out of the wastewater. Pathogens are removed from the water by natural decay, predation from higher organisms, sedimentation and UV irradiation.

Although the soil layer below the water is anaerobic, the plant roots exude (release) oxygen into the area immediately surrounding the root hairs, thus, creating an environment for complex biological and chemical activity.

Design Considerations: The channel or basin is lined with an impermeable barrier (clay or geotextile) covered with rocks, gravel and soil and planted with native vegetation (e.g., cattails, reeds and/or rushes). The wetland is flooded with wastewater to a depth of 10 to 45 cm above ground level. The wetland is compartmentalized into at least two independent flow paths. The number of compartments in series depends on the treatment target. The efficiency of the free-water surface

constructed wetland also depends on how well the water is distributed at the inlet. Wastewater can be fed into the wetland, using weirs or by drilling holes in a distribution pipe, to allow it to enter at evenly spaced intervals.

Appropriateness: Free-water surface constructed wetlands can achieve a high removal of suspended solids and moderate removal of pathogens, nutrients and other pollutants, such as heavy metals. This technology is able to tolerate variable water levels and nutrient loads. Plants limit the dissolved oxygen in the water from their shade and their buffering of the wind; therefore, this type of wetland is only appropriate for low-strength wastewater. This also makes it appropriate only when it follows some type of primary treatment to lower the BOD. Because of the potential for human exposure to pathogens, this technology is rarely used as secondary treatment. Typically, it is used for polishing effluent that has been through secondary treatment, or for storm water retention and treatment.

The free-water surface wetland is a good option where land is cheap and available. Depending on the volume of the water and the corresponding area requirement of the wetland, it can be appropriate for small sections of urban areas, as well as for peri-urban and rural communities. This technology is best suited for warm climates, but can be designed to tolerate some freezing and periods of low biological activity.

Health Aspects/Acceptance: The open surface can act as a potential breeding ground for mosquitoes. However, good design and maintenance can prevent this. Free-water surface constructed wetlands are generally aesthetically pleasing, especially when they are integrated into pre-existing natural areas. Care should be taken to prevent people from coming in contact with the effluent because of the potential for disease transmission and the risk of drowning in deep water.

Operation & Maintenance: Regular maintenance should ensure that water is not short-circuiting, or backing up because of fallen branches, garbage, or beaver dams blocking the wetland outlet. Vegetation may have to be periodically cut back or thinned out.

Plus & Minus

- + Aesthetically pleasing and provides animal habitat
- + High reduction of BOD and solids; moderate pathogen removal
- + Can be built and repaired with locally available materials
- + No electrical energy is required
- + No real problems with odours if designed and maintained correctly
- + Low operating costs

- May facilitate mosquito breeding
- Requires a large land area
- Long start-up time to work at full capacity
- Requires expert design and construction

VERTICAL FLOW CONSTRUCTED WETLAND

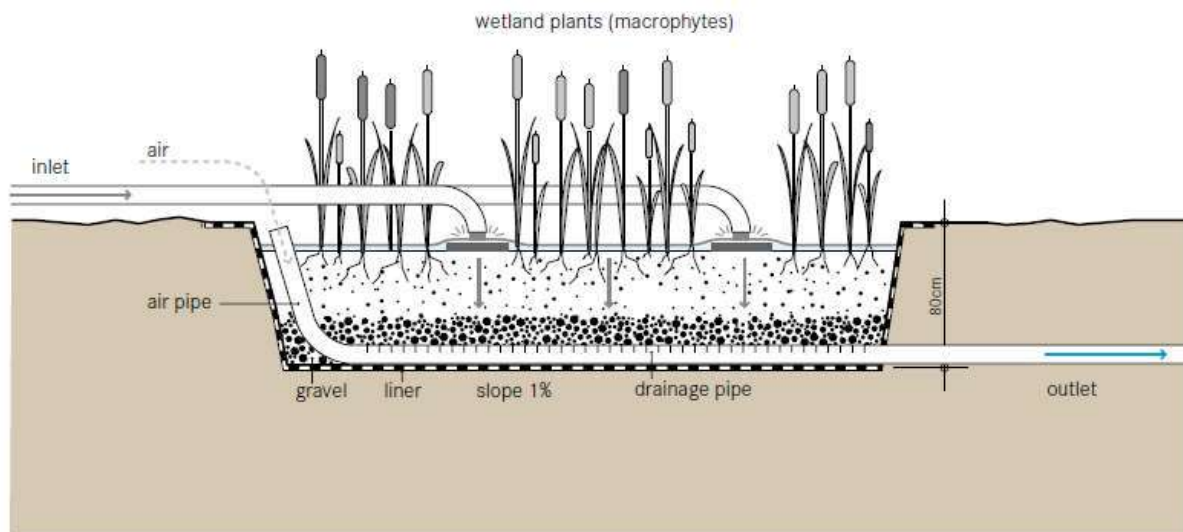

Figure 17: Vertical Flow Constructed Wetland (Source: Tilley *et al*, 2014).

A vertical flow constructed wetland is a planted filter bed that is drained at the bottom. Wastewater is poured or dosed onto the surface from above using a mechanical dosing system. The water flows vertically down through the filter matrix to the bottom of the basin where it is collected in a drainage pipe. The important difference between a vertical and horizontal wetland is not simply the direction of the flow path, but rather the aerobic conditions.

By intermittently dosing the wetland (4 to 10 times a day), the filter goes through stages of being saturated and unsaturated, and, accordingly, different phases of aerobic and anaerobic conditions. During a flush phase, the wastewater percolates down through the unsaturated bed. As the bed drains, air is drawn into it and the oxygen has time to diffuse through the porous media. The filter media acts as a filter for removing solids, a fixed surface upon which bacteria can attach and a base for the vegetation. The top layer is planted and the vegetation is allowed to develop deep, wide roots, which permeate the filter media. The vegetation transfers a small amount of oxygen to the root zone so that aerobic bacteria can colonize the area and degrade organics. However, the primary role of vegetation is to maintain permeability in the filter and provide habitat for microorganisms. Nutrients and organic material are absorbed and degraded by the dense microbial populations. By forcing the organisms into a starvation phase between dosing phases, excessive biomass growth can be decreased and porosity increased.

Design Considerations: The vertical flow constructed wetland can be designed as a shallow excavation or as an above ground construction. Clogging is a common problem. Therefore, the influent should be well settled in a primary treatment stage before flowing into the wetland. The design and size of the wetland is dependent on hydraulic and organic loads. Generally, a surface area of about 1 to 3 m² per person equivalent is required. Each filter should have an impermeable liner and an effluent collection system. A ventilation pipe connected to the drainage system can contribute to

aerobic conditions in the filter. Structurally, there is a layer of gravel for drainage (a minimum of 20 cm), followed by layers of sand and gravel. Depending on the climate, *Phragmites australis* (reed), *Typha* sp. (cattails) or *Echinochloa pyramidalis* are common plant options. Testing may be required to determine the suitability of locally available plants with the specific wastewater.

Due to good oxygen transfer, vertical flow wetlands have the ability to nitrify, but denitrification is limited. In order to create a nitrification-denitrification treatment train, this technology can be combined with a Free-water Surface or Horizontal Flow Wetland.

Appropriateness: The vertical flow constructed wetland is a good treatment for communities that have primary treatment (e.g., Septic Tanks), but are looking to achieve a higher quality effluent. Because of the mechanical dosing system, this technology is most appropriate where trained maintenance staff, constant power supply, and spare parts are available. Since vertical flow constructed wetlands are able to nitrify, they can be an appropriate technology in the treatment process for wastewater with high ammonium concentrations.

Vertical flow constructed wetlands are best suited to warm climates, but can be designed to tolerate some freezing and periods of low biological activity.

Health Aspects/Acceptance: Pathogen removal is accomplished by natural decay, predation by higher organisms, and filtration. The risk of mosquito breeding is low since there is no standing water. The system is generally aesthetic and can be integrated into wild areas or parklands. Care should be taken to ensure that people do not come in contact with the influent because of the risk of infection.

Operation & Maintenance: During the first growing season, it is important to remove weeds that can compete with the planted wetland vegetation. Distribution pipes should be cleaned once a year to remove sludge and biofilm that might block the holes. With time, the gravel will become clogged by accumulated solids and bacterial film. Resting intervals may restore the hydraulic conductivity of the bed. If this does not help, the accumulated material has to be removed and clogged parts of the filter material replaced. Maintenance activities should focus on ensuring that primary treatment is effective at reducing the concentration of solids in the wastewater before it enters the wetland. Maintenance should also ensure that trees do not grow in the area as the roots can harm the liner.

Plus & Minus:

- + High reduction of BOD, suspended solids and pathogens
- + Ability to nitrify due to good oxygen transfer
- + Does not have the mosquito problems of the Free-Water Surface Constructed Wetland
- + Less clogging than in a Horizontal Subsurface Flow Constructed Wetland
- + Requires less space than a Free-Water Surface or Horizontal Flow Wetland
- + Low operating costs

- Requires expert design and construction, particularly, the dosing system
- Requires more frequent maintenance than a Horizontal Subsurface Flow Constructed Wetland
- A constant source of electrical energy may be required
- Long start-up time to work at full capacity
- Not all parts and materials may be locally available

HORIZONTAL SUB-SURFACE FLOW CONSTRUCTED WETLAND

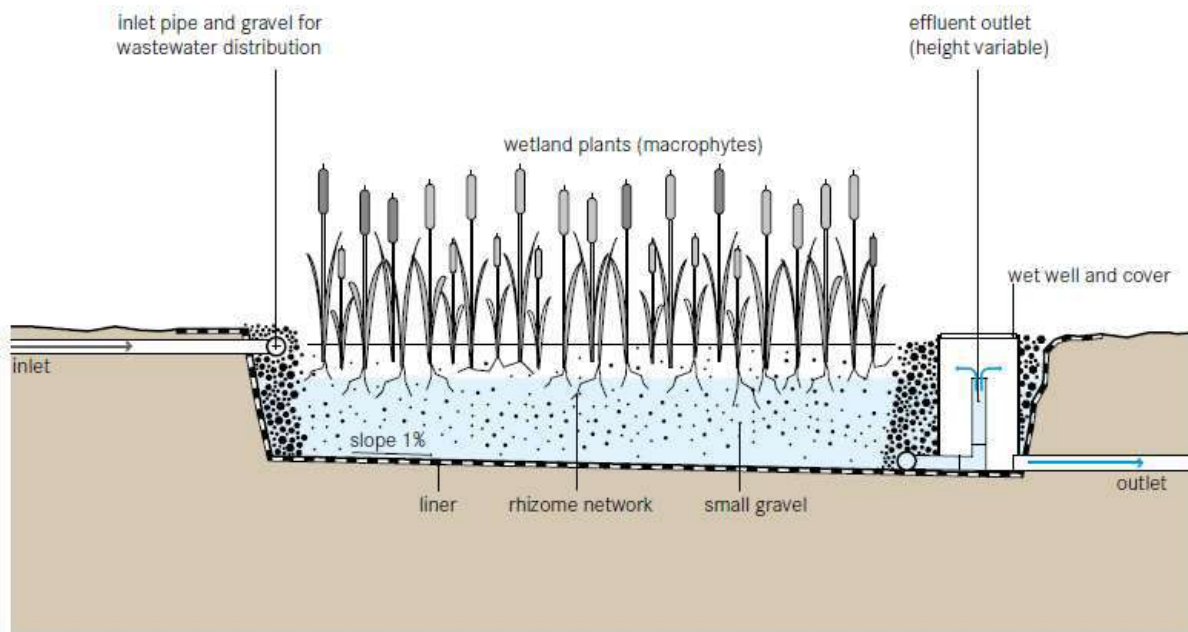

Figure 18: Horizontal Subsurface Flow Constructed Wetland (Source: Tilley *et al*, 2014).

A horizontal subsurface flow constructed wetland is a large gravel and sand-filled basin that is planted with wetland vegetation. As wastewater flows horizontally through the basin, the filter material filters out particles and microorganisms degrade the organics.

The filter media acts as a filter for removing solids, a fixed surface upon which bacteria can attach, and a base for the vegetation. Although facultative and anaerobic bacteria degrade most organics, the vegetation transfers a small amount of oxygen to the root zone so that aerobic bacteria can colonize the area and degrade organics as well. The plant roots play an important role in maintaining the permeability of the filter.

Design Considerations: The design of a horizontal subsurface flow constructed wetland depends on the treatment target and the amount and quality of the influent. It includes decisions about the amount of parallel flow paths and compartmentation. The removal efficiency of the wetland is a function of the surface area (length multiplied by width), while the cross-sectional area (width multiplied by depth) determines the maximum possible flow. Generally, a surface area of about 5 to 10 m² per person equivalent is required. Pre- and primary treatment is essential to prevent clogging and ensure efficient treatment. The influent can be aerated by an inlet cascade to support oxygen-dependent processes, such as BOD reduction and nitrification.

The bed should be lined with an impermeable liner (clay or geotextile) to prevent leaching. It should be wide and shallow so that the flow path of the water in contact with vegetation roots is maximized. A wide inlet zone should be used to evenly distribute the flow. A well-designed inlet that allows for even distribution is important to prevent short-circuiting. The outlet should be variable so that the

water surface can be adjusted to optimize treatment performance. Small, round, evenly sized gravel (3 to 32 mm in diameter) is most commonly used to fill the bed to a depth of 0.5 to 1 m. To limit clogging, the gravel should be clean and free of fines. Sand is also acceptable, but is more prone to clogging than gravel. In recent years, alternative filter materials, such as *Polyethylene terephthalate* (PET), have been successfully used. The water level in the wetland is maintained at 5 to 15 cm below the surface to ensure subsurface flow. Any native plant with deep, wide roots that can grow in the wet, nutrient-rich environment is appropriate. *Phragmites australis* (reed) is a common choice because it forms horizontal rhizomes that penetrate the entire filter depth.

Appropriateness Clogging is a common problem and, therefore, the influent should be well settled with primary treatment before flowing into the wetland. This technology is not appropriate for untreated domestic wastewater (i.e. black-water). It is a good treatment for communities that have primary treatment (e.g., Septic Tanks), but are looking to achieve a higher quality effluent. The horizontal subsurface flow constructed wetland is a good option where land is cheap and available. Depending on the volume of the water and the corresponding area requirement of the wetland, it can be appropriate for small sections of urban areas, as well as for peri-urban and rural communities. It can also be designed for single households.

This technology is best suited for warm climates, but it can be designed to tolerate some freezing and periods of low biological activity. If the effluent is to be reused, the losses due to high evapotranspiration rates could be a drawback of this technology, depending on the climate.

Health Aspects/Acceptance: Significant pathogen removal is accomplished by natural decay, predation by higher organisms, and filtration. As the water flows below the surface, any contact of pathogenic organisms with humans and wildlife is minimized. The risk of mosquito breeding is reduced since there is no standing water compared to the risk associated with Free-Water Surface Constructed Wetlands. The wetland is aesthetically pleasing and can be integrated into wild areas or parklands.

Operation & Maintenance: During the first growing season, it is important to remove weeds that can compete with the planted wetland vegetation. With time, the gravel will become clogged with accumulated solids and bacterial film. The filter material at the inlet zone will require replacement every 10 or more years. Maintenance activities should focus on ensuring that primary treatment is effective at reducing the concentration of solids in the wastewater before it enters the wetland. Maintenance should also ensure that trees do not grow in the area as the roots can harm the liner.

Plus & Minus:

- + High reduction of BOD, suspended solids and pathogens
- + Does not have the mosquito problems of the Free-Water Surface Constructed Wetland
- + No electrical energy is required
- + Low operating costs

- Requires a large land area
- Little nutrient removal
- Risk of clogging, depending on pre- and primary treatment
- Long start-up time to work at full capacity
- Requires expert design and construction

From the above discussion it is evident that selection of wetland option depends on many factors local as well as the volume of flow to handle and the of course the climatic conditions. The discussion above indicates that a horizontal constructed wetland will be much easier to adopt and implement and also the O&M is quite simpler in comparison to other options. However, in order to utilise the nutrient fraction in the effluent it may also entail adoption of a combination of HF and VF. However, under the present context the design of HF has been provided.

FACILITY DESIGN OF WETLAND:

SPREADSHEET RESULT OF CONSTRUCTED WET LAND (HORIZONTAL FILTER)

The above tables and formulae from Sasse, 1998 were adopted to derive the dimension of the gravel filter preceded by ABR and Settling-thickening tanks. Considering the available land area, the wetland has not been duplicated. However, a larger wetland can be constructed or a vertical filter can also be installed / added so that the effluent quality is quite acceptable as per the regulatory norms. The gravel filter will be followed by one small sump for collection and storage of effluent with a one-day capacity for storage and further disposal. The effluent depending upon its design quality can be discharged with low dose chlorination, if discharged to the streams or without chlorination for irrigation of parks that are developed under AMRUT Mission in and around Bhubaneswar town. Since the effluent shall contain nutrients in the form of nitrates and phosphorus, it will be appropriate to use the effluent as water for irrigation through sprinklers or diffusers under the soil. This can also be used to recharge ground water in specific locations away and having a safe distance from surface water sources. The developer / designer shall bring in the technology for such option in using the effluent. Values in figures 14-15 proposed by Sasse, 1998, have been used to size the horizontal filter. The computer spreadsheet developed by Sasse, 1998 for DEWATS has been used to derive the wetland size and loading capacity and compiled in figure 19 below.

| GENERAL SPREADSHEET FOR PLANTED GRAVEL FILTER AND INPUT DATA | | | | | | | | | | | |
|--|--------------|--------------------------|----------------------|--------------------------|-------------------------------|------------------------|--------------|------------------|---------------------------------|-------------------------------------|-----------------------------------|
| Average Flow | COD Inflow | BOD ₅ Inflow | COD/BOD ratio | BOD ₅ Outflow | BOD ₅ Removal rate | COD Removal | COD outflow | Mean Annual Temp | HRT Factor according to k20=0.3 | HRT | Hydraulic Conductance, Ks |
| data | data | data | calc | wanted | calc | calc | calc | data | calc | calc | data |
| m ³ /day | mg/l | mg/l | ratio | mg/l | % | % | mg/l | °C | via graph | days | m/day |
| 75 | 135 | 106 | 1.27 | 9.5 | 91% | 89% | 15 | 25 | 1.1 | 13.81 | 200 |
| | | | | | | 1.025 | | | | | 0.00231 |
| DIMENSIONS | | | | | | | | | | RESULTS | |
| HRT in 30% Pore Space | Bottom Slope | Depth of Filter at Inlet | Cross Section Area | Width of Filter Basin | Surface Area required | Length of Filter Basin | Chosen Width | Length Chosen | Actual Surfacer Area | Hydraulic loading on chosen surface | Organic loading on chosen surface |
| calc | chosen | chosen | calc | calc | calc | calc | chosen | chosen | Check! | calc | calc |
| days | % | m | m ² | m | m ² | m | m | m | m ² | m/day | g/m ² BOD |
| 4.833 | 1% | 0.6 | 53.00 | 88.33 | 1726.18 | 19.54 | 50 | 35 | 1750 | 0.04 | 4.543 |
| | | 0.3 to 0.6m | Max BOD ₅ | 150 | g/m ² | | 88.33 | | Max Load> | 0.10 | 10 |

Fig 19: Showing the Design dimensions of gravel bed filter

DESIGN AND OPERATIONAL PRINCIPLES OF UNPLANTED SLUDGE DRYING BEDS:

Treatment principle

A FS treatment plant (FSTP) or septage treatment plant consists of several drying beds in one location. Sludge is deposited on each of these drying beds where it remains until the desired moisture content is achieved. It is subsequently mechanically or manually removed for disposal or further treatment and reuse.

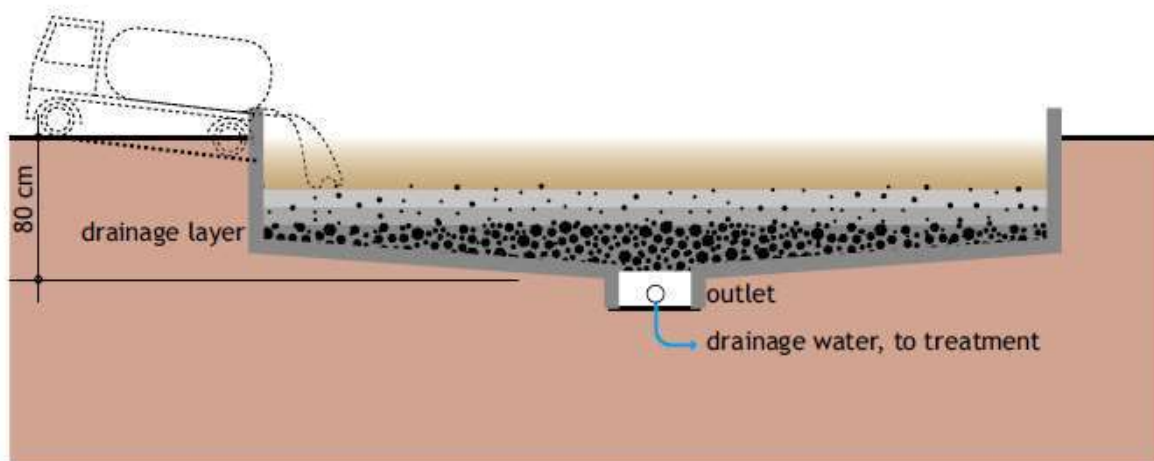

Figure 20: Schematic overview of an unplanted sludge drying bed (Tilley *et al.*, 2014).

The drying process is based on two principles. The first principle is percolation of the leachate through sand and gravel. This process is significant with sludge that contains large volumes of free water and is relatively fast, ranging from hours to days (Heinss *et al.*, 1998). The second process, evaporation, removes the bound water fraction and this process typically takes place over a period of days to weeks. Heinss *et al.* (1998) reported removal of 50 to 80% by volume due to drainage, and 20 to 50% due to evaporation in drying beds with FS. This range is typical for sludge with a significant amount of free water, but there is more evaporation and less percolation with sludge that has more bound water. For example, no leachate was observed in a study with preliminary thickened sludge (Badji, 2011). In planted sludge drying beds evapotranspiration also contributes to water loss.

Unplanted sludge drying bed design parameters

When designing a drying bed, there are several influencing factors that need to be taken into consideration. These aspects vary from location to location, and can be grouped under climate factors and the type of sludge to be treated. Other key parameters that have an impact on the sludge drying process include the sludge loading rate, the thickness of the sludge layer, and the total bed surface. All these aspects are discussed in the following sections.

Climate factors

Climate factors affecting the operation of unplanted drying beds include the following:

- Humidity: high humidity reduces the contribution of evaporation to the drying process;

- Temperature: higher temperatures, also in combination with relatively low humidity and high wind, will enhance the total amount of water removed via evaporation;
- Rainfall: in locations where rainfall is frequent and occurs for long periods of time intense, a drying bed may not be feasible. Pronounced rainy seasons can be accommodated for by not using the beds in that period, or by covering them with a roof. Rainfall will may rewet the sludge, the intensity of which depends on the phase of drying.

Type of faecal sludge

The origin of the sludge is important when using drying beds. Septic tank sludge has less bound water and is hence more readily dewatered than fresh FS. In other words, it is considered to contain a lower specific sludge resistance for dewatering. It therefore can be applied in a thicker sludge layer or at a higher total solids loading rate or at a higher sludge loading rate. Sludge from public toilets is typically not digested: particles have not settled. Because it has a higher specific sludge resistance for dewatering less water will be removed, a longer sludge drying time may be required, or it may not be appropriate for drying beds.

Pescod (1971) carried out experiments with fresh pit latrine sludge on drying beds and obtained a wide variation in drying results – some comparable to more stable sludge. Generally, a proper solid liquid separation is difficult to obtain with fresh public toilet sludge. An alternative is to mix this type of sludge with older, more stabilised sludge (e.g. septic tank sludge) to enhance the dewaterability (Kone *et al.*, 2007; Cofie *et al.*, 2006).

Sludge loading rate

The sludge loading rate (SLR) is expressed in kg TS/ m²/year. It represents the mass of solids dried on one m² of bed in one year. Pescod (1971) states that any general number linking the total amount of sludge to be dried to a sludge loading rate, bed surface area and loading depth can only be an estimate, as the local conditions vary greatly. However, it is possible to indicate a range of sludge loading rates which typically vary between 100 and 200 kg TS/m²/year in tropical climates, with 100 for poorer conditions and 200 for optimal conditions, while approximately 50 kg SS/m²/year is commonly used in temperate climates in Europe (Duchene, 1990). Poor conditions entail high humidity, low temperature, long periods of rainfall, and/or a large proportion of fresh FS. Optimal conditions comprise a low humidity, high temperature, a low amount of precipitation, and stabilised sludge. It may be possible in some cases to achieve an even higher sludge loading rate. Cofie *et al.* (2006) for example applied sludge at a loading rate of up to 300 kg TS/m²/year. Badji (2011) also found a SLR of 300 kg TS/m²/year to be effective for dewatering thickened FS with 60 g TS/L, while about 150 kg TS/m²/year was estimated to be an effective rate for a FS with 5 g TS/L in the same climatic conditions. Optimal local operating conditions need to be determined through pilot-scale experiments.

Thickness of the sludge layer

A review of the literature shows that sludge is typically applied in a layer of 20 to 30 cm in depth, with a preference for 20 cm. It may seem a better option to apply a thicker sludge layer as more sludge can be applied to one bed; however, this will result in an increased drying time, and a reduction in the number of times the bed can be used per year. For any particular sludge dried under the same weather conditions, Pescod (1971) found that an increase in the sludge layer of only 10 cm prolonged the necessary drying time by 50 to 100%.

It is also important that the sidewalls of the drying beds are high enough to accommodate different loadings. For example, if a layer of 20 cm is applied with a water content of 90%, the initial height before the water is drained-off will be much greater than 20 cm. If the beds receive sludge discharged from a truck as opposed to settling tanks, the walls need to be higher than the planned 20 to 30 cm of sludge layer to allow for the increased volume of liquid.

Number of beds

The number of beds required depends on the amount of sludge arriving at the plant per unit of time, the sludge layer thickness and the allowable sludge loading rate. For instance, for two weeks of drying duration and FS arriving 5 days per week, a minimum of 10 beds is required. The number of beds can then be increased or decreased considering the optimal sludge layer thickness. It is also important to adapt the number of beds based on the actual operating conditions, for example frequency of sludge removal, or frequency of rain. An increased number of beds increases the safety factor for adequate treatment with variable FS, or poor operation, but also increases capital costs. Cofie *et al.* (2006) utilised two beds of 25 m², with a loading rate of 7.5 m³ of sludge per bed at a loading depth of 30 cm.

Summary of design parameters

It must be noted that the calculations and figures provided in this note have been provided based on as recommended by Pierre-Henri Dodane *et al* which were determined through local research for the local context based on sludge type and climate and therefore cannot be taken as applicable to all cases. However, they do provide examples of acceptable ranges, and an indication of the interdependency of the factors. In order to provide a suitable drying bed design, the design engineer needs to obtain local knowledge either from experience or from preliminary drying tests under local conditions. The first stage in conducting drying tests will be to determine the number of days required in order to obtain a desired total solids content of the sludge, or at least to obtain a sludge that can be readily removed. If for example the results from these drying tests indicate a two week drying period, including one day for loading and two days for removal, one bed can be filled 26 times per year. Further example calculations are given in illustrations to follow.

Construction of an unplanted sludge drying bed

A drying bed treatment facility consists of the beds with an inlet and an outlet, a leachate collection and drainage system, a designated area outside of the beds for storage and continued drying of the

sludge, and potentially settling-thickening tanks. Sludge can be loaded directly from trucks onto the beds. In this case, various configurations exist such as creating one inlet for two beds, with a splitter to divide the sludge between the beds (Cofie *et al.*, 2006), by designing the bed with a ramp for the inlet of the sludge. Alternatively, a holding or settling tank can be installed into which the sludge is first discharged before being pumped into the drying beds. A splash plate must be used to prevent erosion of the sand layer and to allow even distribution of the sludge (Tilley *et al.*, 2008). This is crucial, as without a splash plate, the sand layer would be destroyed during the very first loading operation. Bar screens at the inlet are essential to keep rubble and trash present in the sludge from entering the bed. This is important to allow for proper use or disposal of the sludge after drying. The drying bed is typically a rectangular shape excavated from the soil, with a sealed bottom. As was shown in Figure 20, the bottom of the bed slopes downwards towards where the drainage system is installed such that the leachate can drain to the discharging point or further treatment. As the leachate is high in suspended solids, organic material, and nutrients, it needs to be treated before it can be discharged to the environment, according to the quality required for reclamation or for receiving water bodies.

Gravel and sand

Layers of gravel and sand are applied on top of the drainage system. When constructing drying beds, it is essential to use washed sand and gravel in order to prevent clogging of the bed from fine particles. This is important both for the initial construction, and for further supplemental additions of sand. The gravel layer functions as a support and there are typically two or three layers with two different diameters of gravel (Figure 20). The distribution of diameter size in the layers is based on avoiding clogging from small particles washing into the drain. The lower layer usually contains coarser gravel with a diameter of around 20-40 mm and the intermediate layer contains finer gravel with a diameter between the coarse gravel and the upper sand layer, for example 5-15 mm. Locally available materials will also have an influence on the design. For example, Cofie *et al.* (2006) made use of gravel with a diameter of 19 mm applied in a 15 cm supporting layer underneath 10 cm of gravel with a 10 mm diameter. To avoid the migration of particles from the sand layer into the gravel layers, a third layer of small gravel can also be used according to what is locally available, for example 2-6 mm.

A sand layer is placed on top of the gravel. The sand layer enhances drainage and prevents clogging, as it keeps the sludge from lodging in the pore spaces of the gravel. The diameter of the sand is crucial as sand with a larger diameter (1.0-1.5 mm) can result in the relatively fast accumulation of organic matter, thereby increasing the risk of clogging, the risk is reduced if sand with a smaller diameter (0.1-0.5 mm) is used (Kuffour *et al.*, 2009).

When selecting sand for the bed, it is important to note that the sand will need to be replaced occasionally, as a certain amount of the sand is bound to the sludge and will therefore be removed when the sludge is removed. It has been recommended by Pierre-Henri Dodane *et al.* that the sand that is chosen is easily obtained. Duchene (1990) reported a loss of a few centimetres of sand for each 5-10 drying sequences. In typical cases like at the Camberene FSTP in Dakar, 5 cm is lost after 25 drying sequences (Badji, 2008).

The sand also needs to be replaced when there is a build-up of organic matter and the bed starts to clog. Kuffour *et al.* (2009) observed a link between the rate of clogging and the rate of organic matter build-up on the sand. As organic matter builds up faster on sand with larger particles, a bed filled with larger diameter sand is more likely to clog. Cofie *et al.* (2006) had to replace the sand twice in a series of 8 dewatering cycles over 10 months due to clogging in a pilot scale implementation. For a full scale application, HPCIDBC (2011) estimated a sand exchange period of three years at a sludge loading rate of 250 kg TS/m²/year, a sludge filling height of 20 cm and a one week drying period (applicable to Nepali conditions).

Sludge removal

In order for the sludge to be removed properly, it needs to be dry enough that it can be shovelled. Pescod (1971) carried out experiments with different types of sludge and treatment technologies, including lagoons and drying beds, and found sludge with a TS content of at least 25% fit for removal. The drying time of a specific sludge type depends on a number of factors, one of which is the sludge dewatering resistance. The higher the sludge dewatering resistance, the lower the drainage rate which leads to a prolonged drainage time. Sludge is removed mechanically or manually, with shovels and wheel barrows being the most common manual method.

In order to remove the sludge, a ramp must be provided to allow wheel barrows or other equipment to access the bed. If a drier sludge is required, this can be achieved by evaporation after it is removed from the drying bed. The dried sludge is frequently stored in heaps for periods of up to one year, during which time pathogen reduction can occur. It is, however, recommended that a more controlled treatment is employed in order to produce reliable and consistent end products.

Rewetting of the sludge is considered problematic if rainfall occurs before the free water of the sludge is completely drained. In this case, the moisture content of the sludge increases again and the drying period is prolonged. When the sludge is already dry enough to expose the sand layer through the cracks in the sludge, rain water can pass straight through the sludge and drains through the drying bed. CPHEEO recommends covering the beds with FRP canopy to avoid rewetting of the sludge. Sasse 1998 also recommends for roofing of drying beds in places receiving frequent rains. Therefore, if budget permits, this should be provided with steel framework to cover dried sludge during rainy days.

Quality of dried sludge and leachate

The main purpose of a drying bed is to achieve dewatering; i.e. a physical separation between liquid and solids. Drying beds are therefore not designed with stabilisation or pathogen removal in mind, although some biodegradation may occur. Therefore, any pollutants present in the FS are not removed and either remain in the sludge or are present in the leachate.

| | First day | Last day | Difference |
|--|-----------|----------|------------|
| pH | 8.2 | 7.9 | -0.3 |
| EC ($\mu\text{S}/\text{cm}$) | 21,900 | 11,400 | -10,500 |
| SS (mg/L) | 600 | 290 | -310 |
| COD (mg/L) | 5,600 | 3,600 | -2,000 |
| BOD (mg/L) | 1,350 | 870 | -480 |
| NH ₃ -N (mg/L) | 520 | 260 | -260 |
| TKN (mg/L) | 590 | 370 | -220 |
| NO ₃ ⁻ -N (mg/L) | 50 | 170 | 120 |

Table 3: Typical characteristics of leachate from sludge drying beds (from Koné *et al.*, 2007)

Kone *et al.* (2007) carried out experiments with mixtures of septic tank and public toilet sludge, and analysed the leachate on the first and the last day of filtration for a variety of parameters. Although the measured concentrations were lower on the last day, the leachate was still far from environmentally safe for disposal with for example a BOD concentration of 870 mg/L. Hence, according to the final use or standards for receiving water bodies, the leachate should be collected and treated as a concentrated liquid waste stream, for example in ponds (Montangero and Strauss, 2002), or recovered for an appropriate end use.

Kone *et al.* (2007) also analysed FS from drying beds for *Ascaris* and *Trichuris* eggs. Sludge was applied in different ratios to unplanted sludge drying beds at a loading rate between 196 and 321 kg TS /m²/year, and left to dry until the TS content was at least 20%. Dewatering on the drying beds alone was not sufficient to inactivate all helminth eggs, and a total count of up to 38 *Ascaris* and *Trichuris* eggs was recovered after dewatering, of which 25–50% were viable (Kone *et al.*, 2007). This illustrates the need for additional storage time or other treatment options for increased pathogen reduction.

FACILITY DESIGN OF UNPLANTED SLUDGE DRYING BED:

Sludge loading rate:

Sludge loading rate of 100 to 200 Kg TS / m² / year has been acceptable in tropical climates. In Bhubaneswar, where number of sunny days in a year can be more than 200 days, a higher loading rate can be adopted. However, based on observations in tropical countries, a loading rate of 150 Kg TS / m² / year may be safely adopted.

Sludge thickness: the range is 20 cms to 30 cms. A thickness of 20 cms is adopted.

No of beds: This is to be designed based on the frequency of loading.

Sludge flow from the thickener: 25 m³ / 10 days.

Each bed will be used two times in a month considering two weeks drying period.

Sludge concentration is 60 Kg TS/m³ from settling-cum-thickening tank.

Sludge produced in a year = $25 \times 3 \times 12 \times 60 = 54000$ Kg

With a loading rate of $150 \text{ Kg} / \text{m}^2$, $54000 / 150 = 360 \text{ m}^2$ of area is required.

Considering a sludge depth of 0.2 m and daily loading of $2.5 \text{ m}^3/\text{day}$, an area of $12.5 \text{ m}^2 / \text{day}$ is required.

Bed L;B ratio may be taken as 5:1 (IS 10037, Pt-1).

Adopting a bed size of $5\text{m} \times 15\text{m}$ i.e. 75 m^2 , no of beds required = $360/60 = 6$

Considering the sludge scraping time, rains, rewetting and drying time and in order to accommodation of overloading, 10 beds may be provided of 75 m^2 size for higher efficiency. The beds may be arranged as twin type with central feeder pipes.

Drying bed wall: this may be constructed using RCC. The free board should be kept a minimum of 0.3 m above the final wet sludge surface. The floors can be built brick on edge and the underdrains can also be made of bricks (fly-ash bricks can be used). The slope towards the drains may be kept 1%. The underdrain width and height shall not be less than 150 mm. laterals can be made of brick on edge with a minimum width of one brick thickness i.e. 75 mm with a spacing of 1 m clear.

Sand and gravel:

Depth of sand bed should be 0.15 m or 150 mm with sand size in the range of 0.5 to 1.0 mm with uniformity coefficient not more than 4.

The gravel layer can be of 300 mm thick with two layers. Bottom layer having size between 20-40 mm and top layer having size 5-15 mm. however a 50 mm layer of 2 mm to 5 mm size gravel above the top layer should be laid to prevent carrying of finer particles of sludge deep into the gravel bed or washing away with the leachate.

Valves. Piping and splash plate etc. are also to be provided for smooth distribution, control and prevention of erosion of sand layer during loading respectively. Refilling of sand after every 25 scrapping of sludge is recommended.

A pump of appropriate capacity is required to be installed in the leachate sump for recycling back to the settler-cum-thickener tank for treatment. The volume of sump = $0.9 \times 25 = 22.5$ Say, 23 m^3 may be provided.

DESIGN AND OPERATIONAL PRINCIPLES OF CO-COMPOSTING:

Co-composting is the controlled aerobic degradation of organics, using more than one feedstock (faecal sludge and organic solid waste). Faecal sludge has a high moisture and nitrogen content, while biodegradable solid waste is high in organic carbon and has good bulking properties (i.e., it allows air to flow and circulate). By combining the two, the benefits of each can be used to optimize the process and the product.

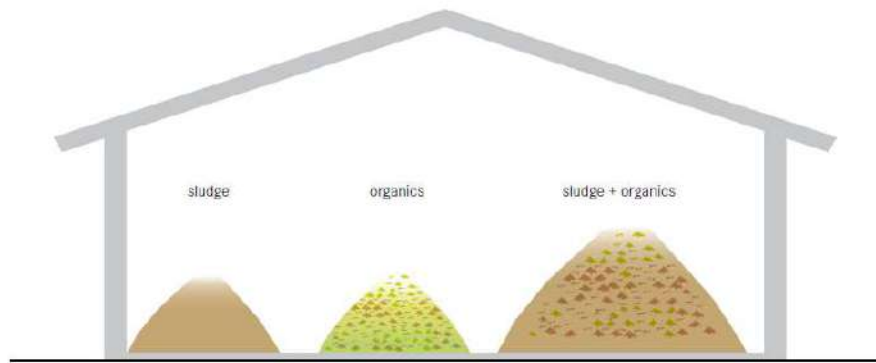

Figure 21: co-composting using bio-organics (Tilley *et al.*, 2014).

There are two types of co-composting designs: open and in-vessel. In open composting, the mixed material (sludge and solid waste) is piled into long heaps called windrows and left to decompose. Windrow piles are periodically turned to provide oxygen and ensure that all parts of the pile are subjected to the same heat treatment. In-vessel composting requires controlled moisture and air supply, as well as mechanical mixing. Therefore, it is not generally appropriate for decentralized facilities. Although the composting process seems like a simple, passive technology, a well-functioning facility requires careful planning and design to avoid failure.

Design Considerations The facility should be located close to the sources of organic waste and faecal sludge to minimize transport costs, but still at a distance away from homes and businesses to minimize nuisances. Depending on the climate and available space, the facility may be covered to prevent excess evaporation and/or provide protection from rain and wind. For dewatered sludge, a ratio of 1:2 to 1:3 of sludge to solid waste should be used. Liquid sludge should be used at a ratio of 1:5 to 1:10 of sludge to solid waste. Windrow piles should be at least 1 m high and insulated with compost or soil to promote an even distribution of heat inside the pile.

Appropriateness A co-composting facility is only appropriate when there is an available source of well-sorted biodegradable solid waste. Solid waste containing plastics and garbage must first be sorted. When carefully done, co-composting can produce a clean, pleasant, beneficial soil conditioner. Since moisture plays an important role in the composting process, covered facilities are especially recommended where there is heavy rainfall.

Apart from technical considerations, composting only makes sense if there is a demand for the product (from paying customers). In order to find buyers, a consistent and good quality compost has to be produced; this depends on good initial sorting and a well-controlled thermophilic process.

Health Aspects/Acceptance Maintaining the temperature in the pile between 55 and 60 °C can reduce the pathogen load in sludge to a level safe to touch and work with. Although the finished compost can be safely handled, care should be taken when dealing with the sludge, regardless of the previous treatment. If the material is found to be dusty, workers should wear protective clothing and use appropriate respiratory equipment. Proper ventilation and dust control are important.

Operation & Maintenance The mixture must be carefully designed so that it has the proper C:N ratio, moisture and oxygen content. If facilities exist, it would be useful to monitor helminth egg inactivation as a proxy measure of sterilization. A well-trained staff is necessary for the operation and maintenance of the facility. Maintenance staff must carefully monitor the quality of the input material, and keep track of the inflows, outflows, turning schedules, and maturing times to ensure a high quality product. Forced aeration systems must be carefully controlled and monitored.

Turning must be periodically done with either a front-end loader or by hand. Robust grinders for shredding large pieces of solid waste (i.e., small branches and coconut shells) and pile turners help to optimize the process, reduce manual labour, and ensure a more homogenous end product.

Plus & Minus

- + Relatively straightforward to set up and maintain with appropriate training
- + Provides a valuable resource that can improve local agriculture and food production
- + A high removal of helminth eggs is possible (< 1 viable egg/g TS)
- + Can be built and repaired with locally available materials
- + Low capital and operating costs
- + No electrical energy required

- Requires a large land area (that is well located)
- Long storage times
- Requires expert design and operation by skilled personnel
- Labour intensive
- Compost is too bulky to be economically transported over long distances

FACILITY DESIGN FOR CO-COMPOSTING:

A facility space preferably shaded and for 200 m² may be provided near to the entrance for co-composting purpose. The product can then be transported and used in the parks and other horticulture areas. The space is to be provided with a shade made of steel frame and GRP material allowing sunlight to the compost area. This facility is optional may be adopted based on market study.

DESIGN AND OPERATIONAL PRINCIPLES OF AEROBIC PONDS:

One maturation pond shall be provided at the end of the stream to provide necessary polishing in the form of removal of *e-coli* from the effluent. The basic design principle suggested by Sasse shall be followed with the help of a spreadsheet calculation. Though the pond system i.e. aerobic and polishing ponds shall be designed, only the polishing pond shall be adopted for the construction purpose since a horizontal filter immediately precedes the maturation pond and the recommended loading rate of BOD₅ on the filter remains around 4 g/m².day.

Aerobic ponds receive most of their oxygen via the water surface. For loading rates below 4 g BOD/m².d, surface oxygen can meet the full oxygen demand. Oxygen intake increases at lower temperatures and with surface turbulence caused by wind and rain. Oxygen intake depends further on the actual oxygen deficit up to saturation point and thus may vary at 20°C between 40 g O₂/m².d for fully anaerobic conditions and 10 g O₂/m².d in case of 75% oxygen saturation.

The secondary source of oxygen comes from algae via photosynthesis. However, in general, too intensive growth of algae and highly turbid water prevents sunlight from reaching the lower strata of the pond. Oxygen “production” is then reduced because photosynthesis cannot take place. The result is a foul smell because anaerobic facultative conditions prevail. Algae are important and positive for the treatment process, but are a negative factor when it comes to effluent quality. Consequently, algae growth is allowed and wanted in the beginning of treatment, but not desired when it comes to the point of discharge, because algae increase the BOD of the effluent. Algae in the effluent can be reduced by a small last pond with maximum 1day retention time. Larger pond area - low loading rates with reduced nutrient supply for algae - are the most secure, but also the most expensive measure.

Aerobic stabilisation ponds for reasons of oxygen intake should be shallow but deep enough to prevent weed growth at the bottom of the pond. A depth of 90 cm to 1 m in warm climate and up to 1.2 m in cold climate zones (due to frost) is suitable. Deeper ponds become facultative or even anaerobic in the lower strata.

FACILITY DESIGN FOR POLISHING POND:

The basic data required for analysis is the volume of flow and pollution load. Starting from these data, the “entrance parameter” is the wanted effluent quality (BOD_{out}, cell F5). The HRT necessary to achieve a certain BOD removal rate depends on temperature. Sludge production may be high in aerobic ponds due to dead algae sinking to the bottom. Assuming a 20% total solids content in compressed bottom sludge and a 50% reduction of volume due to anaerobic stabilisation, almost 4 mm of bottom sludge per gram BOD₅ / m³.d, organic load would accumulate during one year. At loading rates of 15 g BOD₅ / m³.d, approximately 6 cm of sludge are expected per year. However, the sludge volume has not been taken into the calculation because the surface area plays the major role for dimensioning.

| GENERAL SPREADSHEET FOR AEROBIC-FACULTATIVE PONDS, INPUT AND TREATMENT DATA | | | | | | | | | | | |
|---|---|---|----------------|-----------------|--------------------------|--------------------------|---------------------|--------------------------|-------------------------|--------------------------|---------------------|
| Daily Flow | COD Inflow | BOD ₅ Inflow | COD/BOD ratio | Min. Water Temp | BOD ₅ outflow | BOD ₅ Removal | COD Removal | COD Outflow | HRT Factor | HRT | Desludging Interval |
| data | data | data | calc | data | chosen | calc | calc | calc | calc | calc | data |
| m ³ /day | mg/l | mg/l | ratio | mg/l | mg/l | % | % | mg/l | % | days | months |
| 70 | 15 | 9.5 | 1.58 | 20.0 | 5 | 47.37% | 45% | 8 | 0.3 | 5.65 | 12 |
| | | | | | | | | | 0.05-1.0 | | |
| DIMENSIONS OF AEROBIC-FACULTATIVE PONDS | | | | | | | | POLISHING POND 1 DAY HRT | | | TOTAL |
| Accumulated sludge volume | Permitted Organic Load BOD ₅ | Actual Organic Load (BOD ₅) | Depth of ponds | Total Pond Area | Number of main ponds | width of ponds | length of each pond | Area of polishing pond | width of polishing pond | length of polishing pond | Area of all ponds |
| calc | calc | calc | chosen | calc | chosen | chosen | calc | calc | chosen | calc | calc |
| m ³ | g/m ² .day | g/m ² .day | m | m ² | No | m | m | m ² | m | m | m ² |
| 0.466 | 19.31 | 19.31 | 1.00 | 34.44 | 3 | 6.00 | 1.91 | 70.00 | 7.00 | 10.00 | 173.33 |
| 0.00411 | l/g BOD | | 0.9-1.2 | | | | | | | | |

Fig 22: Showing the Design dimensions of Pond System

DIMENSIONING OF VARIOUS UNITS:

1. Screen Channel: (2 nos.)

One sludge receiving chamber of 1.50 m x 1.50 m clear size will be provided
0.6 m (0.3 m SWD) x 3.0 m
Bar screen 1 m wide x 1 m depth – MOC: SS 316
Angle of placement to horizontal 45°, placed on a support channel for easy maintenance.
Feeder channel and bar screen shall be built above ground.
Unloading height shall be between 2 to 3 meters above ground.
Channel to be supported on short columns
Material of construction: R.C.C (M25)

2. Settler-cum-thickener: (2 nos.)

L x B x D = 14.5 m x 2.5 m x 2.55 m (depth at outlet including FB)
Bottom slope 2% reverse.
Pump / sludge pit size 1000 mm x 1000 mm
Material of construction: R.C.C (M25)
Construction is over ground provided the level permits.
Baffles to be placed at 1 m from both ends across the width for flow and scum control.
Emptying period is once every 10 days.
Emptying to be carried out through pump to the SDBs.
All piping shall not be less than 150 mm ϕ
Supernatant shall be withdrawn through gravity to the ABRs
Twin settlers to be provided with common header channel
Lime addition can be done in the header channel, if required.
A walking platform 1000 mm wide to be built all around the settler for maintenance.

3. Unplanted Drying Beds:(10 nos.)

Size: 5000 mm x 15000 mm
Nos: 10 numbers of bed to be provided.
Material of construction of walls: R.C.C (M25)
Material of construction of floors: Fly-ash bricks on edge
Underdrains dimension: 150 mm, brick on edge
Laterals: 75 mm channels placed @ 1 m intervals.
Bed slope of 1% towards the underdrain.
Size of piping up to the leachate sump: 150 mm
Depth of sand bed: 150 mm
Size of sand: 0.5 to 1 mm with UC not more than 4
Depth of gravel bed: 300 mm
Size of gravel: 20-40 mm in bottom half and 5 to 15 mm on top half
Sloped part may be covered with perforated slabs on which the gravels can be placed.
Size of perforated slabs: 1000 mm x 1000 mm x 100 mm

Size of perforation: 20-25 mm

Splash plate of 0.6 m x 1.0 m to be provided on the sand bed at the pipe discharge point.

MOC of splash plate: SS 304 with a minimum thickness of 6 mm to be fixed to the walls through brackets which can be removed during maintenance. The clearance of splash plates from the sand bed shall be 25 mm.

All piping to the SDB shall be 100 mm size and of HDPE material.

All valves shall be of DI make.

The beds are of twin type with central feeder pipes.

4. Anaerobic Baffled Reactors: (2 nos.)

Dimension: 13000 mm x 5000 mm x 2000 mm (1750 mm SWD)

Settler size: 5000 mm x 5000 mm

Up-flow reactor chamber size: 1175 mm x 5000 mm x 1750 mm SWD

Shaft width: 300 mm

MOC: R.C.C (M25), all piping HDPE of 150mm size.

To be built under ground with roof above ground level.

Number of reactor compartments = 5

Size of manhole: 600 mm x 600 mm, all reactors compartments shall have manholes for sludge removal.

Twin tanks of above size with common central wall shall be provided.

Adequate ventilation through piping shall be provided.

The ABRs shall be fed through gravity from the thickener tanks through piping of size not less than 150 mm with provision of DI valves. All piping inside ABR shall be of HDPE type. Details provided in the literature shall be followed while construction. Two extra cells within the ABR may be added for anaerobic filtration.

5. Planted Gravel Filters (Horizontal) (1 no)

Area: 1750 m² (50 m x 35 m)

Slope: 1%, depth at entrance: 0.6 m

COD and BOD₅ out flow: **15 and 9.5** respectively.

40 m wide channel with 50 mm opening shall be used across the width for even distribution of flow to the wetland.

Start depth of 0.6 m and end depth of 0.9 m shall be provided.

Bottom of the wetland may be made of brick flooring with brick on edge.

Washed gravel of size 5 mm – 30 mm shall be provided on the bed.

Water level at 150 mm below the surface shall be maintained.

Phragmites australis (reed) is a common choice to be planted since it forms horizontal rhizomes that penetrate the entire filter depth

The effluent shall be used for irrigation of parks etc.

6. Polishing Pond: (1 no)

Pond area = 70 m², size: 7 m x 10 m

Pond depth = 1.0 m

Brick lining with cement plaster may be provided on the bank for slope protection.

A pump shall be installed for collection of effluent and for further disposal.

7. One leachate sump of 3.0 m dia and 3.00 m deep of RCC with top cover may be provided along with pumping arrangement for feeding to the ABR.

8. Other Ancillary Units:

1. Space for co-composting: a minimum of 200 m² shall be provided
2. Guard room of 10 m² size shall be provided.
3. One production well and one overhead tank of 5000 litres capacity shall be provided.
4. One room 4 m x 6 m size for laboratory equipment purpose shall be provided.
5. One equipment room along with administrative room of size 4 m x 10 m shall be provided for administrative purpose.
6. Since only panels are installed (in case of submersibles), the total pump room area for leachate, sludge and final effluent may be restricted to 12 m².
7. One electrical sub-station of appropriate size.

STRUCTURAL DESIGN OF COMPONENTS:

The major components which shall require a structural detailing are;

1. Screen channel
2. Settling cum thickening tank
3. Anaerobic baffled reactor

The minor components which need to be detailed from construction point of view are;

1. Unplanted Drying Beds
2. Horizontal constructed wetland

Also certain ancillary items are required to support the operational requirement of the septage plant.

They are;

1. Building of about 75 m² area
2. One 800 mm size deep production well and one 5000 litres capacity GRP / HDPE / UPVC overhead tank installed on the building roof.

Design Consideration:

1. The settling tank shall be designed partly underground (the hopper part) and shall be subject to active earth pressure. Therefore, the wall shall be subject to moments with restraint bottom. Ordinarily, in non-traffic sections there will not be any surcharge load due to traffic.
2. In case of ABR, the tanks shall be designed as vessels in series and underground. The inner partitions are subject to water load on one side. The outer walls are subject to active earth load under tank empty conditions. All wall and partitions shall be RCC.
3. The minimum SBC of the soil has been considered to be more than 50.00 kN/m². In case of drying bed, it has a large area for distributing the load, hence it is generally considered safe against settling.
4. Wall section of each channel is designed to establish the structural dimensions. The design is based on limit state method and the sections are designed under the limit state of serviceability.
5. The entire internal area is plastered (Base, Wall) in order to avoid honeycomb and rough patches that may affect the Manning's co-efficient adopted in the hydraulic design. C.I or any durable type rungs are provided on the wall section for ease of entry.

6. Following design principles and data are considered for design of the section;

| | |
|---|---|
| a. Grade of concrete: | M25 |
| b. Grade of steel: | F _e 500 |
| c. Angle of internal friction, Φ : | 33° |
| d. Active Earth Pressure Co-efficient: | $1 - \sin \Phi / 1 + \sin \Phi = 0.33$ |
| e. Soil Density: | 19 kN/m ³ |
| f. $X_{u, \max} / d$ for M25: for F _e 500 | 0.46 |
| g. Factored load for steel at collapse: | 1.15 |
| h. Factored load for concrete at collapse: | 1.5 |
| i. SBC of soil: | > 50 kN/m ² (50 kN/m ² adopted) |
| j. $M_{u, \lim}$ for balanced section: | $0.36 f_{ck} (X_{u, \max} / d) (1 - 0.416 X_{u, \max} / d) b d^2$ |
| k. Minimum surcharge loading on walls: | 20 kN/m ² |
| l. $R_{u, \text{section constant}}$ for F _e 500: | $0.1339 f_{ck}$ |
| m. $M_u / b d^2$: | $0.87 f_y (1 - f_y p / f_{ck})$ |
| n. For axially loaded short columns, P_u | $0.4 f_{ck} A_c + 0.67 f_y A_{sc}$ |

Screen Channel:

Wall:

The screen channel will be supported on a short column with a maximum spacing of 3 meters.

| | |
|--------------------------------|--|
| Depth of channel: | 600 mm |
| Clear width: | 300 mm |
| Assume side wall thickness, D: | 100 mm |
| Water pressure: | $0.6 \times 10 = 6 \text{ kN / m}^2$ |
| Max moment on the wall: | $0.33 \times 0.5 \times 6 \times 0.6 = 0.594 \text{ kN – m}$ |
| M_u : | $0.594 \times 1.5 = 0.891 \text{ kN – m}$ |
| d_u : | $\sqrt{(0.891 \times 1000 / 3.348)} = 16.31 \text{ mm}$ |

by placing the steel at the center of the section, $d_u = 50 \text{ mm}$

$$M_u / b d^2 = 0.891 \times 1000 / 50^2 = 0.3564, P_t = 0.082 \text{ (Table – 3, SP-16)}$$

$$\text{Tensile reinforcement, } A_{st} = 0.082 \times 1000 \times 100 / 100 = 82 \text{ mm}^2$$

$$\text{Minimum tensile reinforcement} = 0.85 \times 1000 \times 100 / 500 = 170 \text{ mm}^2$$

Provide minimum reinforcement using #8 mm bars @ $50.24 \times 1000 / 170 = 295.5 \text{ mm c/c}$

Actual spacing @ 250 mm c/c may be provided.

Transverse bars at same spacing may be provided.

Base slab:

$$\text{Width of slab} = 300 + 200 = 500 \text{ mm}$$

$$\text{Udl on slab} = 0.3 \times 0.6 \times 10 + 0.2 \times 0.5 \times 25 + 0.1 \times 2 \times 0.6 \times 25 = 7.3 \text{ kN/m}$$

Consider maximum span of slab = 3.0 m

$$\text{Moment, } M = 7.3 \times 3^2 / 8 = 8.2125 \text{ kN.m}$$

$$M_{\text{ultimate}} = 1.5 \times 8.2125 = 12.32 \text{ kN.m}$$

$d_u = \sqrt{(12.32 \times 1000 / 3.348)} = 60.66$ mm, provide an overall depth of 150 mm,

$d_u = 75$ mm, $M_u/bd^2 = 12.32 \times 1000 / 75^2 = 2.19$, $P_t = 0.569$ (Table – 3, SP-16)

$A_{st} = 0.569 \times 1000 \times 75 / 100 = 426.75$ mm²

Using # 10 mm bars, spacing = $78.5 \times 500 / 426.75 = 91.97$ mm, provide @ 75 mm c/c.

Transverse bars of # 8 mm may be provided @ 250 mm c/c

Cantilever Beam:

Two channels will be provided without any gap i.e. with one common partition wall of 100 mm thick RCC. Member.

Length of cantilever = 50 + 300 + 100 = 0.45 m

Assuming a 200 x 200 section

Superimposed load on each column = $(3 \times 0.15 \times 0.9 \times 25 + 3 \times 0.1 \times 0.6 \times 3 \times 25 + 0.2 \times 0.2 \times 0.9 \times 2 \times 25 + 0.6 \times 0.6 \times 10 \times 3) / 2 = 18.11$ kN

Udl on one cantilever = $18.11/0.45 = 40.25$ kN/m

Max moment = $40.25 \times 0.45^2 / 2 = 4.075$ kN.m

$M_u = 1.5 \times 4.075 = 6.11$ kN.m, $d_u = \sqrt{(4.075 \times 10^6 / 200 \times 3.348)} = 78$ mm

Effective depth taken = $200 - 50 - 6 = 144$ mm (OK)

$M_u/bd^2 = 4.075 \times 10^6 / 200 \times 144^2 = 0.983$, $P_t = 0.23$, $A_{st} = 0.23 \times 200 \times 144 / 100 = 66.24$ mm²

Provide #12 mm 3 nos, $A_{st} = 3 \times 113 = 339$ mm² (OK)

8 mm 2-legged stirrups may be provided @ 200 mm c/c.

Design of column:

Height of the column = 1.5 m

Section: 250 mm x 250 mm

Load on each column = $18.11 + 1.5 \times 0.0625 \times 25 = 20.45$ kN

$e_{min} = (l/530) + (D/30) = (1500/530) + (250/30) = 11.16$ mm

Minimum eccentricity = $0.05D = 0.05 \times 250 = 12.5$ mm which is within 20 mm. (Clause 25.4, IS 456/2000)

$P_u = 0.4f_{ck}.A_c + 0.67f_y.A_{sc}$

$1.5 \times 20.45 \times 10^3 = 0.4 \times 25 \times (250 \times 250 - A_{sc}) + 0.67 \times 500 \times A_{sc}$

$\Rightarrow 30675 = 625000 - 10A_{sc} + 335A_{sc}$

The above equation provides a negative A_{sc} which means, the concrete can take the entire load.

However, minimum reinforcement of 0.8% is to be provided.

$A_{sc} = 0.008 \times 250^2 = 500$ mm², #16 mm bars 2 nos and #12 mm 2nos may be provided.

#8 mm tie may be provided @ 150 mm c/c

Isolated footing of uniform depth:

Load, $W = 20.45$ kN, $W' =$ weight of footing = 20% of $W = 6.09$ kN

Footing area 'A' = $(20.45 + 6.09) / 50 = 0.53$ m² = 0.73 m x 0.73 m

Provide 1.0 m x 1.0 m area.

Net upward pressure under factored load $P_{0u} = 1.5 \times 20.45 / 1 = 30.675$ kN/m²

$X_{u,max}/d = 0.46$ for $F_e = 500$

$$R_u = 0.36 \times 25 \times 0.46(1 - 0.416 \times 0.46) = 3.3478$$

$$M_u = P_u \times (B/8) \times (B - b)^2 \times 10^6 = \text{N-mm}$$

$$= 30.675 \times 1/8 \times (1 - 0.25)^2 \times 10^6 = 2.16 \times 10^6 \text{ N-mm}$$

$$d_u = \sqrt{[(2.16 \times 10^6) / (3.3478 \times 1000)]} = 25 \text{ mm which is small.}$$

We shall therefore provide an overall thickness of 300 mm and 0.12% steel in the base.

Allowable load transfer at base $\sqrt{A_1/A_2} = 2$

$$A_1 = 62500 \text{ mm}^2, A_2 = [250 + 2 \times (2 \times 300)]^2 = 2102500 \text{ mm}^2$$

$$\sqrt{A_1/A_2} = 1 < 2 \text{ OK}$$

$$\text{Permissible bearing stress} = 0.45 \times f_{ck} \times \sqrt{A_1/A_2} = 0.45 \times 25 \times 1 = 10 \text{ N/mm}^2$$

$$\text{Actual bearing pressure} = 30.68 \times 1000 / 250^2 = 0.49 \text{ N/mm}^2, \text{ hence safe.}$$

Design of settling tank:

Length of tank = 14.5 m, width = 2.5 m, SWD = 2.55 m

Concrete M25, $\sigma_{cbc} = 8.5 \text{ N/mm}^2$, $m = 280 / (3 \times 8.5) = 10.98$, $\sigma_{st} = 130 \text{ N/mm}^2$

$$k = (10.98 \times 8.5) / [(10.98 \times 8.5) + 130] = 0.418$$

$$j = (1 - k/3) = 0.861, R = 0.5 \times 8.5 \times 0.418 \times 0.861 = 1.53$$

L/H = 5.68, B/H = 1, values beyond 3 for L/H is not available in IS 3370 Pt-4.

Hence analysis, based on approximate method, shall be carried out.

Long wall:

Water load at base = $10 \times 2.55 = 25.5 \text{ kN/m}^2$, the walls shall be subject to a cantilever moment with max value at base = $10 \times 2.55^3 / 6 = 27.64 \text{ kN-m}$

$$\text{Direct tension on the long walls} = 10 \times (2.55 - 2.55/4) \times 2.5/2 = 23.91 \text{ kN}$$

$$d = \sqrt{(27640 / 1.53)} = 134 \text{ mm}$$

Provide a thickness of 250 mm at base uniformly tapered to 150 mm at the top.

The short walls will also have the same dimensions.

Weight of walls = $2 \times 0.2 \times 14.5 \times 25 \times 2.55 + 2 \times 0.2 \times 2.5 \times 25 \times 2.55 + 20\% \times (2 \times 0.2 \times 14.5 \times 25 \times 2.55 + 2 \times 0.2 \times 2.5 \times 25 \times 2.55) + 2 \times 14.5 \times 10 \times 2.5 + 0.2 \times 36.25 \times 25 = 1426.45 \text{ kN}$

Area of tank = 36.25 m^2 , pressure = $1426.45 / 36.25 = 39.35 \text{ kN / m}^2 < 50 \text{ kN / m}^2 \text{ (OK)}$

Max horizontal moment in short wall = $10 \times (2.55 - 0.64) \times 2.5^2 / 16 = 7.46 \text{ kN-m} < 27.64$, hence the vertical moment is governing.

Max cantilever moment at 1 m in short wall = $10 \times 2 \times 0.64^2 / 6 = 1.365 \text{ kN-m}$, small.

$$\text{Pull on long wall} = 10 \times (2.55 - 0.64) \times 2.5/2 = 23.88 \text{ kN}$$

$$\text{Pull on short wall} = 10 \times (2.55 - 0.64) \times 1 = 19.1 \text{ kN}$$

Reinforcement for long walls:

$$\text{Fixing moments for short walls} = 10 \times (2.55 - 0.64) \times 2.5^2 / 16 = 7.46 \text{ kN-m}$$

$$\text{Direct tension} = 10 \times (2.55 - 0.64) \times 1 = 19.1 \text{ kN, lever arm, } x \text{ for tensile force} = 200 - 250/2 = 75 \text{ mm}$$

$$A_{stb} = 27.64 \times 1000 \times 1000 / (130 \times 0.861 \times 220) = 1122.45 \text{ mm}^2$$

$$\text{Tensile steel in long wall} = 19.1 \times 1000 / 130 = 146.9 \text{ mm}^2$$

$$\text{Total steel} = 1269.35 \text{ mm}^2, \text{ steel on each face} = 634.7 \text{ mm}^2$$

$$\text{Minimum steel in horizontal direction} = 0.0012 \times 1000 \times 200 = 240 \text{ mm}^2$$

Provide **vertical steel # 12 mm bars**, at $113 \times 1000 / 634.7 = 178.03 \text{ mm}$, **provide @ 175 mm c/c**

Provide **horizontal steel # 8 mm** at 209 mm c/c, **provide at 200 mm c/c**

Reinforcement for short wall:

Moment in short wall in horizontal direction = $10 \times 1.61 \times 2.5^2 / 16 = 6.29 \text{ kN-m}$, low.

The same reinforcement as provided for the long wall shall also be provided in the short wall.

Max bending tension = $27.64 \times 1000 \times 6 / 250^2 = 2.65 \text{ N/mm}^2 > 1.8 \text{ kN/mm}^2$

Provide base thickness of 350 mm uniformly tapered to 250 mm at top

Max bending tension = $27.64 \times 1000 \times 6 / 350^2 = 1.35 \text{ N/mm}^2 < 1.8 \text{ kN/mm}^2$

Max direct tension = $19100 / (1000 \times 300) = 0.063 \text{ N/mm}^2$

$(1.35/1.8) + (0.063/1.3) = 0.798 < 1$ (OK), the section remains under un-cracked condition.

Reinforcement on both faces and both direction should be provided at the above spacing in a staggered fashion.

The base slab shall transmit water load direct to the soil.

The slab thickness may be adopted as 250 mm with nominal reinforcement using #10 mm bars @ 200 mm c/c on both directions at bottom face.

Anaerobic Baffled Reactor Tank:

The tank shall be built as independent cells placed adjacent to each other. The first cell is the settler and the rest five cells are the reactors.

Settler:

Size: 5.00 m x 5.00 m, L/B = 1.00, L/H = 5/2 = 2.5 (IS 3370 Pt-4, 1999)

Max moment co-efficient = 0.035

Considering top free and all three edges fixed for the wall panel, max vertical moments at $b/a = 2.5$ are, $0.035 \times 10 \times 2^3 = 2.8 \text{ kN-m}$.

Vertical moment being governing, $d = \sqrt{2.8 \times 1000 / 1.53} = 42 \text{ mm}$

Provide 200 mm overall thickness with $d = 200 - 40 - 5 = 155 \text{ mm}$

$A_{st} = 2.8 \times 10^6 / (130 \times 0.861 \times 155) = 161.4 \text{ mm}^2$. Minimum = $0.0012 \times 1000 \times 200 = 240 \text{ mm}^2$

Using #10 mm bars, spacing on each face = $78.5 \times 1000 / 120 = 654.17 \text{ mm c/c}$

Provide # 10 mm @ 200 mm c/c on both faces and both directions in staggered manner.

Reactor cells:

Size: 5.00 m x 1.175 m, L/B = 4/1.175 = 3.404 > 3

Long walls (partitions) are designed as cantilevers.

Vertical moment = $10 \times 2^3/6 = 13.33 \text{ kN-m}$

Overall thickness = 200 mm

Provided # 10 mm bars @ 200 mm c/c on both faces and directions.

Baffles with nominal reinforcement and 75-100 mm thick shall be provided wherever necessary or pipes of 150 mm dia can also be used in place of baffles.

Roof slab of ABR settler:

L/B = 1.00, slab spanning in both directions.

End condition for settler: Slab freely supported on three edges and continuous over the other.

$M_x = 0.057 \times w l_x^2$ (IS 456/2000)

W = dead load (0.125 x 25) + live load (5) + finishing load (1) = 9.125 kN/m²

$M_x = 0.057 \times 9.125 \times 4^2 = 8.322 \text{ kN-m}$ (maximum of all moments)

$d_e = \sqrt{(8.322 \times 1000 / 1.53)} = 73 \text{ mm}$, provide overall depth, D = 125 mm

$A_{st} = 8.322 \times 10^6 / (130 \times 0.861 \times 100) = 743.5 \text{ mm}^2$

$A_{st, min} = 0.0012 \times 1000 \times 125 = 150 \text{ mm}^2$

Provide # 10 mm bars. Spacing = $78.5 \times 1000 / 743.5 = 105.67 \text{ mm}$, provide at 100 mm c/c. Provide on both faces. 50% extra may be provided on top face at l/8 over the continuous edges.

Base Slab:

Base slab will transmit entire water load to the soil. A 250 mm thick slab with 0.12% reinforcement will be sufficient for flexural strength of the slab.

$$A_{st} = 0.0012 \times 250000 = 300 \text{ mm}^2, \text{ spacing} = \# 10 \text{ mm @ } 78.5 \times 1000 / 300 = 261.6 \text{ mm.}$$

Provide @ 250 mm c/c.

Drying Beds:

All drying beds shall be placed adjacent with common separator walls over continuous footings.

The walls are not subject to any lateral load except while emptying the whole bed.

Wall height = sand (150 mm) + Gravel (300 mm) + sludge (200 mm) + free board (300 mm) = 950 mm

Provide a wall thickness of 200 mm.

$$\text{Provide nominal reinforcement} = 0.0012 \times 1000 \times 200 = 240 \text{ mm}^2$$

Provided # 8 mm bars on both faces.

Steel, A_{st} on each face = $50.24 \times 1000 / 120 = 418 \text{ mm}$, provide at 250 mm c/c on both faces and directions.

Provide a footing width of 600 mm of 200 mm uniform depth. Base reinforcement may be provided with # 8 mm bars @ 250 mm c/c on both directions.

Horizontal Gravel Filter:

Dimension: 50 m x 35 m x 1 m

5 m x 5 m floor panels may be provided with proper jointing and sealing.

Nominal reinforcement may be provided using # 8 mm bars @ 300 mm c/c with reinforcement continuous. The walls may be made 150 mm thick.

$$\text{Lateral saturated earth pressure} = 0.33 \times 19 \times 1 = 6.27 \text{ kN/m}$$

$$\text{Moment } M_b = 0.33 \times 0.5 \times 1 \times 6.27 = 1.03 \text{ kN-m/m}$$

$$M_{ub} = 1.5 \times 1.03 = 1.55 \text{ kN-m}$$

$$M_u/bd^2 = 1.55 \times 1000 / 75^2 = 0.276, P_t = 0.12\%, \text{ minimum}$$

Provide nominal reinforcement using # 8 mm bars @ $50.24 \times 1000 / (0.0012 \times 1000 \times 150) = 279 \text{ mm}$

Provide @ 250 mm c/c at the center of section.

Wall panels of 3 m length may constructed with vertical joints to allow expansion.

Appropriate joint filler shall be provided.

The wall footing shall be of 150 mm section with nominal reinforcement as that in the wall.

Cover slabs:

Removable cover slabs wherever provided shall be of 75 mm thick and size not exceeding 1200 mm x 600 mm with nominal reinforcement. In case of cover slabs having length $\geq 2000 \text{ mm}$, the thickness should be increased to 100 mm with consideration of live load of 5 kN/m^2 . However, the width should not exceed 750 mm for ease of removal and handling.

Leachate Sump: $H^2/Dt = 9/(3 \times 0.3) = 10$ (IS-3370, Pt-4, 1999)

$$\text{Max moment at base} = 0.0122 \times 10 \times 3^3 = 1.098 \text{ kN-m, Max tension} = 0.608 \times 10 \times 3 \times 1.5 = 27.36 \text{ kN}$$

Since the sump will be underground, the wall in general will be subjected to compression. Hence nominal reinforcement of # 10 mm bars can be provided @ 0.12% on both faces subject to a maximum spacing of 250 mm c/c.

ECONOMIC AND FINANCIAL ASPECTS

For any project to be economically viable, its financial status needs to be analysed. According to market principles and growth of economy it is necessary that any investment shall produce some tangible benefits in financial terms. The benefits may be direct or indirect and these are to be examined with relation to the investment made in the project. Even though wastewater treatment may not produce appreciable financial viability, the methods of economic analysis such as cost-benefit or break-even point, are important, and requires to be worked out to examine the future sustainability of the project. The annual cost method, which includes depreciation on capital investment and operational costs, appears to be more apt as an economic indicator. With this method it is easy for the polluter to include expenses such as discharge fees, or income from reuse of by-products on an annual base, to get a comprehensive picture of the economic implications.

The annual cost method could also be used for estimating social costs and benefits. The economic impact of treatment on the environment and on public health is related primarily to the context in which a treatment plant operates. For example, if properly treated wastewater is discharged into a river that is already highly polluted the yield from fishing will surely not improve. On the contrary, if all the inflows into the receiving water were to be treated to the extent that the self-purifying effect of the river would allow the fish to grow, this would have considerable economic impact. This economic impact of a cleaner river is crucially dependent on the total number of treatment plants installed along the river, and not only on the efficiency of one single plant. Similarly, in arid and semi-arid areas, use of effluent for land irrigation can considerably improve the economy and growth.

Capital Cost:

a. Cost of Land

Available literature on the subject reveals that for economic calculation the value of land remains the same over years and thus, land has unlimited lifetime. However, the price of land is never stable. It usually goes up in times of growth and may go down in times of political turbulence. In reality, the actual availability of land is far more important than the price; new land will rarely be bought only for the purpose of a treatment plant. The density of population usually determines the price of land. Land is likely to cost more in areas with a high population density and vice versa. The choice of treatment system is severely influenced by these facts.

In reality, the cost of land may or may not be essential to the comparison between different treatment systems. Wide differences in the cost of land notwithstanding, it may contribute in the range of 80% of the total cost of construction. It follows that at least in theory, the choice of sand filters and of ponds will be more affected by the price of land than compact anaerobic digesters. In any case, it is most likely that where land prices are high, compact tanks - not ponds and filters - will be the natural choice. *Alaerts et al* assume that ponds are the cheapest alternative when the cost of land is in the range of less than 15 US\$/m² in case of post treatment and 3 - 8 US\$/m² in case of full treatment. Such figures nonetheless have always to be checked locally.

b. Cost of Construction

Annual costs are influenced by the lifetime of the hardware. It may be assumed that building and ground structures have a lifetime of 20 years; while filter media, some pipelines, manhole covers, etc. are only likely to last for 10 years. Other equipment such as valves, gas pipes, etc., may stay durable for 6 years. Practically it suffices to relate any structural element to any one of these three categories. It is assumed that full planning costs will reoccur at the end of the lifetime of the main structure, i.e. in about 20 years. In any individual case, the costs of planning can be estimated. For dissemination programmes, it may be assumed that planning will be carried out by a local engineering team of sound experience to whom the design and implementation of DEWATS is a routine matter. However, this might not be so in reality. At the contrary, of all costs, engineering costs are likely to be the most exorbitant and to remain so until such time as the level of local engineering capacity improves. An estimation of planning workdays for senior and junior staff forms the basis of calculation to which 100% may be added towards acquisition and general office overheads. Transport of personnel for building supervision and sample taking - and laboratory cost for initial testing of unknown wastewater's must also be included.

c. Running Costs

Running expenses include the cost of personnel for operation, maintenance and management, including monitoring. Cost may be based on the time taken by qualified staff (inclusive of staff trained on the job) to attend to the plant. The time for plant operation is normally assessed on a weekly basis. In reality, the time estimated for inspection and attendance would hardly call for additional payment to those staff who are permanently employed. The case would be different for service personal that is specially hired. Facilities that are shared, as in the case of 5 to 10 households joining their sewers to one DEWATS, are likely to be 10% cheaper than individual plants. However, operational reliability of such a facility cannot be guaranteed if someone is not specially assigned to the task of maintenance. Cost for regular attendance could be higher for open systems such as ponds or constructed wetlands due to the occasional damage or disturbance by animals, stormy weather or falling leaves. The cost of regular de-sludging will be higher for tanks with high pollution loads, than for ponds which receive only pre-treated wastewater. The cost of cleaning the filter material is not considered to be running cost as these costs are taken care off by the reduced lifetime of the particular structure. So also the cost of energy and chemicals that are added permanently are not included, as such costs are not typical of DEWATS.

Income from Wastewater Treatment

The calculation of income from by-products or activities related to wastewater treatment calls for careful selection of the right economic parameters. In case of septage biogas is not an option since the septage is partly digested and has lost most of its potential in producing the bio-gas. Therefore, the income may have to be channelized trough sale of effluent and dried sludge as fertilizer / manure. The size and organisation of the farm together with the marketing of the crops would be important parameters to consider.

Under the current context it is required to have a through market study on the potential demand for use of effluent and dried sludge. As an interim, the effluent may be used for irrigation of parks with treatment and sludge as manure to be used in public parks etc.

ABSTRACT

| Sl. No. | Component | Amount (Rs) |
|----------------|--|-------------------------------|
| A | Capital Works | |
| 1 | Sludge receiving chamber | 101,300.00 |
| 2 | Screen Chamber | 1,12,800.00 |
| 3 | Settling -cum- Thickening Tank | 14,85,600.00 |
| 4 | Hybrid ABR with AF | 21,04,800.00 |
| 5 | Planted Horizontal Gravel Filter | 59,58,800.00 |
| 6 | Unplanted Drying bed | 33,67,900.00 |
| 7 | Maturation Pond + Cost of pump | 3,75,000.00 |
| 8 | Other Ancillary Units | 1,52,29,900.00 |
| | Sub total | 2,87,36,100.00 |
| | Add 1% contingency | 2,87,361.00 |
| | Total (A) | 2,90,23,461.00 |
| | Operation & Maintenance for 5 years (B) | 96,65,800.00 |
| | Grand Total | 3,86,89,261.00 |
| | | Say Rs. 3,86,89,000.00 |

(Rupees three core eighty six lakh eighty nine thousand) only

| | | | | | | | | | |
|--|--|--|--|--|--|-----|-----|-------------------|--|
| Add for earth work, back filling & disposal of surplus | | | | | | | | | |
| earth 15% of civil work | | | | | | | Rs. | 3,167.97 | |
| | | | | | | | | | |
| Add cost of cost of bar screen (1 m x 1 m) = | | | | | | | | | |
| | | | | | | | Rs. | 88,500.00 | |
| | | | | | | | | 112,787.79 | |
| | | | | | | Say | Rs. | 112,800.00 | |

| Settling cum Thickening Tank (2 nos.) | | | | | | | | | |
|---|---|---|-----|--|--|-----|-----|---------------------|------------|
| RCC M25 | | | | | | | | | |
| Baffle wall | 2 x 2 x 2.5 m x 0.6 m x 0.1 | = | | | | | | 0.60 | cum |
| Tank wall | 2 x 2 x (14.7m + 2.7m) x 2.55m x 0.2m | = | | | | | | 35.50 | cum |
| Tank Base | 2 x 14.7m x 2.7m x 0.25m | = | | | | | | 21.61 | cum |
| | | | | | | | | 57.71 | cum |
| | | | | | | | | | |
| | @ Rs. 5775.60/cum | = | Rs. | | | | | 333309.88 | |
| Centering & Shuttering | | | | | | | | | |
| Wall Quantity = 36.10 cum | | | | | | | | | |
| | @ 2.00 sqm/cum = 72.20 sqm @ Rs.454.40 | = | Rs. | | | | | 32807.68 | |
| Base qty = 21.61 cum | @ 1.5 sqm/cum = 32.42 sqm @ 92.90 | | Rs. | | | | | 3011.82 | |
| HYSD reinforcement | | | | | | | | | |
| Quantity = 57.71 cum | | | | | | | | | |
| | @ 1 Qtl/ cum = 57.71 Qtl @ Rs. 5381.40 | = | Rs. | | | | | 310560.59 | |
| Sand filling | | | | | | | | | |
| | 2 x 14.9m x 2.9m x 0.15 m =12.76 cum @ Rs. 314.60 | = | Rs. | | | | | 4077.22 | |
| PCC (1:2:4) | | | | | | | | | |
| | 2 x 14.9 x 2.9 x 0.1m = 8.64 cum @ Rs.5825.8 | = | Rs. | | | | | 50334.91 | |
| | | | | | | | | 734102.10 | |
| Add 15% of CW for e/w, back filling & disposal of surplus earth | | | | | | | | | |
| | | | | | | | | 110115.32 | |
| | | | | | | | | 844217.42 | |
| Add for piping 20% of above | | | | | | | | | |
| | | | | | | | | 168843.48 | |
| Add for sludge pump (2 nos.) | | | | | | | | | |
| @ Rs. 50,000/E | | | | | | | Rs. | 100000 | |
| | | | | | | (A) | Rs. | 10,13,060.90 | |

| | | | | | |
|---------------------------------------|-------------------------|--|-------|----------|-------------------|
| Walk way 1000m wide all around | | | | | |
| S/s Hand-railing = 117 m | | | | | |
| | @Rs. 3392.00 | | Rs. | 3,96,864 | |
| Sand filling = 59.5 x 0.15 | | | | | |
| | =8.93 cum @ Rs.314.60 | | Rs. | 2809.38 | |
| PCC (1: 2 : 4) = | | | | | |
| | 59.5 x 0.1 m = 5.95 cum | | | | |
| | @ Rs. 5825.80 | | Rs. | 34663.51 | |
| Chequered tile = 59.5 sqm | | | | | |
| | @ Rs. 641.10 | | Rs. | 38145.45 | |
| | | | (B) | Rs. | 472482.34 |
| | | | (A+B) | Rs. | 1485543.24 |

| Anaerobic Baffled Reactors (2 Nos.) | | | | |
|--|-----------------------------|--|-------|-----------|
| RCC M-25 | | | | |
| Base Slab | 2 x 12.28 x 5.40 x 0.25 = | | 33.16 | Cum |
| Long wall | 2 x 2 x 12.28 x 0.2 x 2.0 = | | 19.65 | Cum |
| Short wall | 2 x 7 x 5.0 x 0.2 x 2.0 = | | 28.00 | Cum |
| Roof slab | 2 x 12.28 x 5.40 x 0.125 = | | 16.58 | Cum |
| Baffle wall | 2 x 5 x 2 x 0.1 | | 2.00 | Cum |
| | @ Rs.5775.60/cum | | Rs. | 574036.88 |
| Centering & shuttering | | | | |
| Base slab | | | | |
| Quantity = 33.16 cum | | | | |
| C/s @ 33.16 x 2 = 66.32 sqm @Rs.92.90/ sqm | | | Rs. | 6161.13 |
| Wall | | | | |
| Quantity = 49.65 cum | | | | |
| C/s @ 2.00 sqm/ cum = 99.30 sqm @ Rs.454.40/ sqm | | | Rs. | 45121.92 |
| Roof slab | | | | |
| Quantity = 16.58 cum | | | | |
| C/s @ 10sqm/ cum = 16.58 x 10= 165.80 sqm @ Rs.529.20/ sqm | | | Rs. | 87741.36 |
| HYSD reinforcement | | | | |
| 99.39 qtl @ Rs. 5381.40 | | | Rs. | 534857.35 |

| | | | | |
|--|--|--------------|------------|-----------------------------|
| Sand filling | | | | |
| 2 x 12.28 x 5.4 x 0.15 = 19.89 cum @ Rs. 314.60/cum | | | Rs. | 6257.39 |
| PCC (1: 2 :4) | | | | |
| 2 x 12.28 x 5.4 x 0.10 = 13.26 cum @Rs.5825.80/cum | | | Rs. | 77250.11 |
| | | | Rs. | 1331426.14 |
| Add for earth work, back filling & disposal of surplus | | | | |
| earth 15% of civil work. | | | Rs. | 199713.92 |
| | | | Rs. | 1531140.06 |
| Add 25% for piping work | | | Rs. | 382785.02 |
| | | Total | Rs. | 1913925.08 |
| | | | | Say Rs. 19,13,900.00 |

| | | | | |
|---|--|---------------|--------------|-----------------------|
| Planted Gravel Filter (Horizontal)- 1 No. | | | | |
| M-25 | | | | |
| Foundation - 2 x (50.3m + 35.3m) x 0.3m x 0.15m = | | | | 7.70 cum |
| Wall - 2 x (50.15 + 35.15) x 1.0m x 0.15m = | | | | 25.59 cum |
| | | | Total: | 33.29 cum |
| | | @ Rs. 5775.60 | Rs. | 192269.72 |
| Centering & shuttering | | | | |
| Foundation – 7.70 cum | | | | |
| Quantity 1.50 sqm/cum = 11.55 sqm | | | | |
| | | @ Rs. 92.90 | Rs. | 1073.00 |
| Wall - 25.59 cum | | | | |
| Quantity @ 2.00 sqm/ cum = 51.18 sqm | | | | |
| | | @ Rs. 454.40 | Rs. | 23256.19 |
| HYSD reinforcement | | | | |
| RCC M25 = 33.29 cum | | | | |
| Quantity 1qtl/ cum = 33.29 qtl. | | @ Rs.5381.40 | Rs. | 179146.81 |
| Brick flooring with brick on edge | | | | |
| No. of bricks = 50 x x 35m x 0.12 m = 210 cum @ Rs. 3860.20 | | | Rs. | 810642.00 |
| Washed Gravel Bed | | | | |
| 50 m x 35 m x 0.8 m = 1400 cum | | @Rs. 2000 | Rs. | 2800000.00 |
| | | | Total | Rs. 4006387.72 |

| | | | | | | |
|--|--|--|------------------|--------------|----------------|---------------------|
| Add 10% of CW for earth work & disposal of surplus earth | | | | | Rs. | 400638.77 |
| | | | | Total | Rs. | 44,07,026.49 |
| Add 25% for plantation & construction of channels. | | | | | Rs. | 11,01,756.62 |
| RCC collection sump of size 15 cum | | | | | | |
| | | | @ Rs. 30000/cum. | | Rs. | 450000.00 |
| | | | | | Rs. | 5958783.12 |
| | | | | | | |
| | | | | | Say Rs. | 59,58,800.00 |

| Unplanted Drying Beds (10 Nos.) | | | | | | |
|--|---|--|-------------------|---|-----|-----------|
| M-25 | | | | | | |
| Footing | 10 x 2 x (15.6 + 5.6) x 0.6 x 0.2 = 50.88 cum | | | | | |
| Wall | = | 10 x 2 x (15.2+5.2) x 0.95 x 0.2 m = 77.52 cum | | | | |
| | | 128.40 cum | @ Rs. 5775.60 = | = | Rs. | 741587.04 |
| Wall C/S @ 2.00 sqm/ cum | | = 155.04 sqm @ Rs. 454.40 | | = | Rs. | 70450.18 |
| Footing @ 1.5 sqm / cum | | = 76.32 sqm @ Rs. 92.90 | | = | Rs. | 7090.13 |
| HYSD reinforcement | | | | | | |
| | | 128.40 qtl | @ Rs. 5381.40 | = | Rs. | 690971.76 |
| Sand filling | | | | | | |
| | | 10 x 15m x 5m x 0.15 m = 112.50 cum @ Rs. 314.60 | | = | Rs. | 35392.50 |
| Gravel Bed | | | | | | |
| | | 10 x 15m x 5m x 0.3m = 225 cum @ Rs.2000/cum | | = | Rs. | 450000.00 |
| | | | | | | |
| | | | | | | |
| | | | | | | |
| | | | | | | |
| Fly ash brick on edge. | | | | | | |
| | | 8 x 15m x 5 x 0.12m = 90.0 cum | @ Rs. 3860.20/cum | | Rs. | 347418.00 |

| | | | | | | | | |
|--|--|--|--|--|--|--|-----|---------------------------|
| | | | | | | | | 2342909.61 |
| Add 15% for earth work, back filling & disposal of surplus earth | | | | | | | Rs. | 351436.44 |
| | | | | | | | | 2694346.05 |
| Add 25 % for piping lateral etc. | | | | | | | Rs. | 673586.51 |
| | | | | | | | | 3367932.56 |
| | | | | | | | | Say Rs. 3367900.00 |

| Maturation Pond & Sludge receiving chamber | | | | | | | | |
|--|--|--|--|--|--|--|--|------------------|
| | | | | | | | | |
| Maturation pond 1.0m deep (7.0 m x 10.0m) | | | | | | | | |
| | | | | | | | | |
| | | | | | | | | @ Rs.2500/ sqm |
| | | | | | | | | Rs. 175000.00 |
| Cost of recirculation pump L.S. | | | | | | | | Rs. 100000.00 |
| Elevated receiving sludge chamber (1.5m x 1.5m x 1.5m) | | | | | | | | |
| | | | | | | | | @ Rs. 30000/ cum |
| | | | | | | | | Rs. 101,250.00 |
| Cost of leachate and effluent pump L.S. | | | | | | | | Rs. 100000.00 |

| Other Ancillary units | | | | | | | | |
|------------------------------|---|--|--|--------------|------------|--|--|-------------------|
| | | | | | | | | |
| 1 | Space for co-composting | | | | | | | |
| | 200 sqm @ Rs. 2800/sqm = | | | | Rs. | | | 560,000.00 |
| | Sliding Shed over SDB 375 m ² @ 2200 /m ² | | | | Rs. | | | 8,25,000.00 |
| 2 | Guard Room of size (3.0m x 3.0m) | | | | | | | |
| | Plinth area = 3.5m x 3.5m = 12.25 sqm. | | | | | | | |
| | PWD Rate (10//2013) = Rs. 1184.00 / sft/ | | | | | | | |
| | Rate @ 10% enhancement annually | | | | | | | |
| | Rs.1184.00 x 91.1)3 = Rs.1575.00/sft. | | | | | | | |
| | Cost of Guard room = 12.25 x 17000/ sqm = | | | | Rs. | | | 208,250.00 |
| | Add 35% for internal E/I + Internal PH +External PH = | | | | Rs. | | | 72,888.00 |
| | | | | Total | Rs. | | | 281,138.00 |
| 3 | Room (4m x 6m) for Laboratory | | | | | | | |
| | Plinth area 4.5 m x 6.5m = 29.25 sqm. | | | | | | | |
| | Basic cost 29.25 sqm @ Rs. 17000/sqm = | | | | Rs. | | | 497,250.00 |
| | Add 35% for Int E/Int PH & Ext PH | | | | Rs. | | | 174,038.00 |
| | | | | | Rs. | | | 671,288.00 |

| | | | |
|-----------|---|-------------------|---------------------|
| 4 | Equipment room & Administrative room (4m x 10m) | | |
| | Plinth Area = 4.5m x 10.5 m = 47.25 sqm | | |
| | Basic cost 47.25 sqm @ Rs. 17000/sqm | Rs. | 803,250.00 |
| | Add 35% for int. e/l + PH + Ext. PH | Rs. | 281,138.00 |
| | | Rs. | 1,084,388.00 |
| 5 | One production well with OHT of 5000 ltr. capacity | | |
| a | Production well with s/s pump set | Rs | 300,000.00 |
| b | OHT of 5000 ltr. capacity with piping work @ Rs. 7/1ltr. | Rs. | 35,000.00 |
| c | Staging for OHT | Rs. | 15000.00 |
| 6 | Electrical sub-station 25 KVA | Rs. | 250,000.00 |
| 7 | Yard lighting | Rs. | 250,000.00 |
| 8 | Internal road (3.5 m width) | | |
| | 1000 mtr. @ Rs. 4663.60 | Rs. | 4663600.00 |
| 9 | Protection wall around the SeTP site- 255mtr. | Rs. | 3500000.00 |
| 10 | Site Development, plantation, landscaping, Lab equip etc. | <u>Rs.</u> | 2500000.00 |
| <u>11</u> | Pump house for leachate pumping (3 m x 4 m) | Rs. | |
| | Plinth area = 3.5 x 4.5 = 15.75 sqm @ 17000/sqm | Rs. | 267750.00 |
| <u>12</u> | Add 10 for internal elect. | Rs. | 26775.00 |
| | | Total: Rs. | 15229900.00 |

| Anaerobic filters (2 chambers) | | | | |
|---------------------------------------|---|-------------|------------|------------------|
| Footing | 2.98 cum | | | |
| Wall | 5.44 cum | | | |
| Roof | 0.62 cum | | | |
| Total: | 9.04 cum @ 5775.60/cum | | Rs. | 52211.42 |
| Centering & Shuttering | | | | |
| footing | 4.47 sqm @ 92.90 | | Rs. | 415.26 |
| Wall | 10.88 sqm @ 454.40 | | Rs. | 4943.87 |
| Roof | 6.20 sqm @ 529.20 | | Rs. | 3281.04 |
| HYSD Bars for 9.04 cum | 8.42 qtl @ 5381.40 | | Rs. | 48647.86 |
| Sand filling | 2.23 cum @ 314.60 | | Rs. | 701.56 |
| PCC below footing | 1.49 cum @ 5825.80 | | Rs. | 8680.44 |
| | | | Rs. | 118889.42 |
| | 15% back filling and surplus earth disposal | | Rs. | 178832.22 |
| | Add 25% for piping | | Rs. | 34178.42 |
| | Add cost of plastic media | | Rs. | 20000.00 |
| | | Total: | Rs. | 190892.00 |
| | | Say, | Rs. | 190900.00 |

**BHUBANESWAR
ANALYSIS (2015-16)**

| Sl. No. | Description of items. | Qty. | | Unit | Rate | Amount | Remarks |
|---------|---|-------|-----|------|---------|---------|------------|
| | | | | | in Rs. | in Rs. | |
| 1 | Earth work in ordinary soil within 50m initial lead & 1.5m initial lift including dressing and levelling of the foundation trenches etc. all complete as per direction of Er-in - charge. | | | | | | |
| | Per 100cum | | | | | | |
| | Man mulia | 16.00 | Nos | Each | 200.00 | 3200.00 | |
| | Female mulia | 16.00 | Nos | Each | 200.00 | 3200.00 | |
| | | | | | A | 6400.00 | |
| | O.H.C. 7.5% on (A) | | | | | 480.00 | |
| | CP. 7.5% on (A) | | | | | 480.00 | |
| | | | | | Total | 7360.00 | |
| | add for dressing and leveling | 20% | | | | 1472.00 | |
| | | | | | Total | 8832.00 | Per 100cum |
| | | | | | Cess-1% | 88.32 | |
| | | | | | | 8920.32 | Per 100cum |
| | | | | | | 89.20 | per cum |
| 2 | Earth work in hard soil within 50m initial lead & 1.5m initial lift including dressing and levelling of the foundation trenches etc. all complete as per direction of Er-in - charge. | | | | | | |
| | Per 100cum | | | | | | |

| | | | | | | | |
|----------|---|--------------------|-----|------|---------------------|----------|---------------|
| 5 | Earth work in excavation in foundation | | | | | | |
| | in all kind of soil | | | | | | |
| | a) Earth work in all kinds of soil per 100cum | | | | | 9123.33 | |
| | b) Add for levelling & dressing | | | | 20% | 1824.67 | |
| | | | | | | 10948.00 | |
| | | | | | Cess-1% | 109.48 | |
| | | | | | | 11057.48 | per 100cum |
| 6 | Filling in foundation & plinth with excavated materials including watering & ramming as directed by the Er-in charge. | | | | | | |
| | | Rate of earth work | | | A | 9123.33 | |
| | | 2/3rd rate of (A) | | | | 6082.22 | |
| | | | | | Total | 6082.22 | Per 100cum |
| | | | | | Cess-1% | 60.82 | |
| | | | | | | 6143.04 | Per 100cum |
| | | | | | | 61.43 | Per cum |
| 7 | Suppling all materials, labour and T&P for Filling in foundation & plinth with sand watered & rammed etc. all complete. | | | | | | |
| | Per 100cum | | | | | | |
| | Man mulia | 12.36 | Nos | Each | 200.00 | 2472.00 | |
| | O.H.C. 7.5% on (A) | | | | | 185.40 | |
| | CP-7.5% on (A) | | | | | 185.40 | |
| | | | | | Total | 2842.80 | Per 100cum |
| | | | | | Per 1cum | 28.43 | |
| | Cost of sand filling | 1.00 | cum | cum | 44.00 | 44.00 | |
| | Carriage of sand | 1.00 | cum | cum | 239.04 | 239.04 | |
| | | | | | Total | 311.47 | Per cum |
| | | | | | Cess-1% | 3.11 | |
| | | | | | Total | 314.58 | Per cum |

| | | | | | | | |
|----------|--|------|------|------|---------|----------------|---------|
| 8 | Cement concrete (1:3:6) with 4cm size crusher | | | | | | |
| | broken hard granite metal including cost, conveyance, royalties etc. all complete. | | | | | | |
| | <u>Material</u> | | | | | | |
| | Metal (4cm size) | 0.96 | cum | cum | 742.00 | 712.32 | |
| | Sand for filling | 0.48 | cum | cum | 49.00 | 23.52 | |
| | Cement | 2.29 | Qntl | Qntl | 714.00 | 1635.06 | |
| | <u>Labours</u> | | | | A | 2370.90 | |
| | Mason 2nd class | 0.18 | Nos | Each | 240.00 | 43.20 | |
| | Man mulia | 2.50 | Nos | Each | 200.00 | 500.00 | |
| | Female mulia | 1.40 | Nos | Each | 200.00 | 280.00 | |
| | | | | | | 823.20 | |
| | O.H.C. 7.5% on (A) | | | | | 239.56 | |
| | CP-7.5% | | | | | 239.56 | |
| | | | | | B | 3637.22 | |
| | <u>Carriage & royalties</u> | | | | | | |
| | Metal | 0.96 | cum | cum | 604.78 | 580.59 | |
| | Sand for mortar | 0.48 | cum | cum | 239.04 | 114.74 | |
| | Cement | 2.29 | Qntl | Qntl | 16.90 | 38.70 | |
| | | | | | Total | 4407.25 | Per cum |
| | | | | | Cess-1% | 44.07 | |
| | | | | | Total | 4451.32 | Per cum |
| 9 | Cement concrete (1:4:8) with 4cm size crusher | | | | | | |
| | broken hard granite metal including cost, conveyance, royalties etc. all complete. | | | | | | |
| | <u>Material</u> | | | | | | |
| | Metal (4cm size) | 0.96 | cum | cum | 720.00 | 691.20 | |
| | Sand | 0.48 | cum | cum | 47.00 | 22.56 | |
| | Cement | 1.72 | Qntl | Qntl | 714.00 | 1228.08 | |
| | <u>Labours</u> | | | | | | |

| | | | | | | | |
|-----------|--|------|------|------|---------|---------|---------|
| | Mason 2nd class | 0.18 | Nos | Each | 240.00 | 43.20 | |
| | Man mulia | 2.50 | Nos | Each | 200.00 | 500.00 | |
| | Female mulia | 1.40 | Nos | Each | 200.00 | 280.00 | |
| | | | | | A | 2765.04 | |
| | O.H.C. 7.5% on (A) | | | | | 207.38 | |
| | CP 7.5% on (A) | | | | | 207.38 | |
| | | | | | B | 3179.80 | |
| | <u>Carriage & royalties</u> | | | | | | |
| | Metal | 0.96 | cum | cum | 347.20 | 333.31 | |
| | Sand for mortar | 0.48 | cum | cum | 183.84 | 88.24 | |
| | Cement | 1.72 | Qntl | Qntl | 16.90 | 29.07 | |
| | | | | | Total | 3630.42 | Per cum |
| | | | | | Cess-1% | 36.30 | |
| | | | | | | 3666.72 | Per cum |
| | | | | | | | |
| 10 | Cement concrete (1:2:4) with 12cm size crusher | | | | | | |
| | broken hard granite chips including cost, conveyance, royalties etc. all complete. | | | | | | |
| | <u>Material</u> | | | | | | |
| | Chips (12mm size) | 0.90 | cum | cum | 1151.00 | 1035.90 | |
| | Sand for mortar | 0.45 | cum | cum | 52.00 | 23.40 | |
| | Cement | 3.23 | Qntl | Qntl | 714.00 | 2306.22 | |
| | <u>Labours</u> | | | | | | |
| | Mason 2nd class | 0.68 | Nos | Each | 240.00 | 163.20 | |
| | Man mulia | 3.20 | Nos | Each | 200.00 | 640.00 | |
| | Female mulia | 1.40 | Nos | Each | 200.00 | 280.00 | |
| | | | | | A | 4448.72 | |
| | O.H.C. 7.5% on (A) | | | | | 333.65 | |
| | CP 7.5% on (A) | | | | | 333.65 | |
| | | | | | B | 5116.03 | |

| | | | | | | | |
|-----------|--|-----------------|-----|------|--------------|--------------|----------|
| 12 | Suppling, fitting & placing uncoated HYSD bar reinforcement complete as per drawing and technical specification including cost, conveyance of all materials etc. all complete. | | | | | | |
| | Unit-1MT | | | | | | |
| | Taking Output-1MT | | | | | | |
| | <u>Material</u> | | | | | | |
| | HYSD bars including 5% overlaps & wastage. | 1.05 | MT | MT | 41033.00 | 43084.65 | |
| | Binding wires | 8 | kg | kg | 77.00 | 616.00 | |
| | <u>Labours</u> | | | | | | |
| | Mate | 0.44 | Nos | Each | 220.00 | 96.80 | |
| | Blacksmith(special) | 3.00 | Nos | Each | 260.00 | 780.00 | |
| | Man mulia | 8.00 | Nos | Each | 200.00 | 1600.00 | |
| | | | | | A | 46177.45 | |
| | O.H.C. 7.5% on(A) | | | | | 3463.31 | |
| | CP. 7.5% on(A) | | | | | 3463.31 | |
| | Carriage & Royalty | 1.05 | mt | | 169 | 177.45 | |
| | | | | | B | 53281.52 | Per MT |
| | | Rate per 1qntl. | | | Total | 5328.15 | Per qntl |
| | | Cess 1% | | | | 53.28 | |
| | | | | | Rate per qtl | 5381.43 | |
| | | | | | | Say, 5381.40 | |
| 13 | Rigid & smooth centering & shuttering for R.C.C. works including false work & dismantling them after casting including cost of materials complete in ground floor | | | | | | |
| | | | | | | | |

| | | | | | | |
|--|------------------------------|---------------|------|----------|----------|----------|
| i)Roof slab, landing & chajjas up to 4.3m height. | | | | | | |
| Details for 9sqm. | | | | | | |
| Non sal wood scantling | 0.112 | cum | cum | 19788.00 | 2216.26 | |
| Planks 38mm | 0.34 | cum | cum | 19788.00 | 6727.92 | |
| 120mmdia bullah | 56.00 | mtr | mtr | 101.00 | 5656.00 | |
| carriage of wood | 1.142 | 1.25 | cum | 135.20 | 154.40 | |
| | | cum | | A | 14754.58 | |
| Considering 10 times use of the materials for use once | | 1/10th of (A) | | B | 1475.46 | |
| Carpenter 2nd class | 2.75 | Nos | Each | 240.00 | 660.00 | |
| Semiskilled mulia | 2.75 | Nos | Each | 220.00 | 605.00 | |
| | | | | C | 2740.46 | |
| O.H.C. 7.5% on (C) | | | | | 205.53 | |
| CP. 7.5% on (C) | | | | | 205.53 | |
| | | | | D | 3151.53 | |
| | Rate per 1sqm. | | | E | 350.17 | Per sqm. |
| | | | | Cess-1% | 3.50 | |
| | | | | | 353.67 | Per sqm. |
| | For 1st floor add extra 20% | | | | 70.03 | |
| | For 1st floor | | | F | 423.71 | Per sqm. |
| | For 1st floor add extra 20% | | | | 84.74 | |
| | For 2nd floor | | | G | 508.45 | Per sqm. |
| | Average rate=(E+F+G)= | | | | 427.44 | Per sqm. |
| ii)R.C.C. foundation & plinth band, footings, bases of columns etc. | | | | | | |
| Details for 10sqm. | | | | | | |

| | | | | | | | |
|--|--|----------------|---------------|------|-------------------------|---------|----------|
| | 25mm thick non sal planks | 0.267 | cum | cum | 19788 | 5283.40 | |
| | Non sal bullah 80mmdia for strusting | 12.6 | mtr | mtr | 48 | 604.80 | |
| | carriage of wood | 0.3284 | cum | cum | 135.2 | 44.40 | |
| | | | | | A | 5932.60 | |
| | Considering 10 times use of the materials for use once | | 1/10th of (A) | | B | 593.26 | |
| | Carpenter 2nd class | 0.50 | Nos | Each | 240.00 | 120.00 | |
| | Semiskilled mulia | 0.50 | Nos | Each | 220.00 | 110.00 | |
| | | | | | C | 823.26 | |
| | O.H.C. 7.5% on (C) | | | | | 61.74 | |
| | Cp. 7.5% on (C) | | | | | 61.74 | |
| | | | | | D | 946.75 | |
| | | Rate per 1sqm. | | | | 94.67 | Per sqm. |
| | | | | | Cess-% | 0.95 | |
| | | | | | | 95.62 | |
| | | | | | | | |
| | iii)R.C.C. beams & columns. | | | | | | |
| | <u>Details for 4.2sqm.</u> | | | | | | |
| | 38mm thick non sal planks | 0.218 | cum | cum | 19788.00 | 4313.78 | |
| | 120mmdia bullah | 15.2 | mtr | mtr | 76.00 | 1155.20 | |
| | Sal bullah 80mmdia for bracing | 8 | mtr | mtr | 76.00 | 608.00 | |
| | carriage of wood | 0.456 | cum | cum | 80.00 | 36.48 | |
| | | | | | A | 6113.46 | |
| | Considering 10 times use of the materials for use once | | 1/10th of (A) | | B | 611.35 | |
| | Carpenter 2nd class | 2.75 | Nos | Each | 240.00 | 660.00 | |
| | Semiskilled mulia | 2.75 | Nos | Each | 220.00 | 605.00 | |
| | | | | | C | 1876.35 | |
| | O.H.C. 7.5% on (C) | | | | | 140.73 | |
| | Contractors profit@7.5% | | | | | 140.73 | |
| | | | | | D | 2157.80 | |
| | | Rate per 1sqm. | | | E | 513.76 | Per sqm. |
| | | | | | Cess@1% | 5.14 | |
| | | | | | - | 518.90 | Per sqm. |

| | | | | | | | |
|-----------|--|------------------------------|---------------|------|----------------|---------|----------|
| | | | | | | | |
| | | For 1st floor add extra 20% | | | | 102.75 | |
| | | For 1st floor | | | F | 1140.55 | Per sqm. |
| | | For 1st floor add extra 20% | | | | 228.11 | |
| | | For 2nd floor | | | G | 1368.66 | |
| | | Average rate=(E+F+G)= | | | | 1007.66 | Per sqm. |
| | iii)R.C.C. lintels. | | | | | | |
| | <u>Details for 7.8sqm.</u> | | | | | | |
| | 38mm thick non sal planks | 0.413 | cum | cum | 19788.00 | 8172.44 | |
| | 120mmdia non sal bullah | 21 | mtr | mtr | 56.00 | 1176.00 | |
| | carriage of wood | 0.689 | cum | cum | 80.00 | 55.12 | |
| | | | | | A | 9403.56 | |
| | Considering 10 times use of the materials for use once | | 1/10th of (A) | | B | 940.36 | |
| | Carpenter 2nd class | 1.25 | Nos | Each | 240.00 | 300.00 | |
| | Semiskilled mulia | 1.25 | Nos | Each | 220.00 | 275.00 | |
| | | | | | C | 1515.36 | |
| | O.H.C. 7.5% on (C) | | | | | 113.65 | |
| | <u>CP @ 7.5%</u> | | | | | 113.65 | |
| | | | | | D | 1742.66 | |
| | | | | | <u>Cess@1%</u> | 17.43 | |
| | | | | | | 1760.09 | |
| | | Rate per 1sqm. | | | | 225.65 | Per sqm. |
| | | | | | | | |
| 14 | Fly Ash bricks masonry in CM (1:6) using fly ash | | | | | | |
| | brick of size 25cmx12cmx8cm including cost conveyance, royalties of all materials etc. all complete. | | | | | | |
| | <u>Labours</u> | | | | | | |
| | Mason special | 0.35 | Nos | Each | 260.00 | 91.00 | |
| | Mason 2nd class | 1.05 | Nos | Each | 240.00 | 252.00 | |

| | | | | | | | |
|-----------|---|-----------------|------|------|---------|---------|---------|
| | Man mulia | 1.41 | Nos | Each | 200.00 | 282.00 | |
| | Female mulia | 1.41 | Nos | Each | 200.00 | 282.00 | |
| | Preparing mortar & getting water etc. | 0.14 | Nos | Each | 200.00 | 28.00 | |
| | <u>Material</u> | | | | | | |
| | fly ash Bricks (25cmx12cmx8cm size) | 350 | Nos | 1000 | 4600.00 | 1610.00 | |
| | | | | Nos | | | |
| | Sand (screened & washed) | 0.28 | cum | cum | 52.00 | 14.56 | |
| | Cement | 0.672 | qntl | qntl | 714.00 | 479.81 | |
| | | | | | A | 3147.87 | |
| | O.H.C. 7.5% on (A) | | | | | 236.09 | |
| | CP. 7.5% on (A) | | | | | 236.09 | |
| | | | | | B | 3620.05 | |
| | <u>Carriage & royalties</u> | | | | | | |
| | Fly ash Bricks(25cmx12cmx8cm size) | 350 | Nos | 1000 | 505.40 | 176.89 | |
| | | | | Nos | | | |
| | Sand for mortar | 0.28 | cum | cum | 183.84 | 51.48 | |
| | Cement | 0.672 | qntl | qntl | 16.90 | 11.36 | |
| | | | | | Total | 3859.77 | Per cum |
| | | | | | Cess-1% | 38.60 | |
| | | | | | | 3898.37 | Per cum |
| 15 | Fly ash brick masonry in CM (1:6) using fly ash | | | | | | |
| | brick of size 25cmx12cmx8cm including cost | | | | | | |
| | conveyance, royalties of all materials etc. all | | | | | | |
| | complete. | | | | | | |
| | | Rate of F&P.per | | | | 3859.77 | |
| | | cum. | | | | | |
| | | Add for super | | | | 33.00 | |
| | | structure | | | | | |
| | | | | | Total | 3892.77 | Per cum |
| 15 | Brick works with K.B. bricks having crushing strength between 100kg/sq.cm to 149kgsq.cm in C.M. (1:8) in foundation & plinth including cost, conveyance, royalties of all materials etc. all complete | | | | | | |

| | | | | | | | |
|-----------|--|-------------------------|------|------|---------|----------|---------|
| | <u>Labours</u> | | | | | | |
| | Mason special | 0.35 | Nos | Each | 260.00 | 91.00 | |
| | Mason 2nd class | 1.05 | Nos | Each | 240.00 | 252.00 | |
| | Man mulia | 1.41 | Nos | Each | 200.00 | 282.00 | |
| | Female mulia | 1.41 | Nos | Each | 200.00 | 282.00 | |
| | Preparing mortar & getting water etc. | 0.14 | Nos | Each | 200.00 | 28.00 | |
| | <u>Material</u> | | | | | | |
| | K.B. Bricks (25cmx12cmx8cm size) | 350 | Nos | 1000 | 5692.00 | 1992.20 | |
| | | | | Nos | | | |
| | Sand (screened & washed) | 0.28 | cum | cum | 51.00 | 14.28 | |
| | Cement | 0.501 | qntl | qntl | 651.60 | 326.45 | |
| | | | | | A | 3267.93 | |
| | O.H.C. 10% on (A) | | | | | 326.7932 | |
| | | | | | B | 3594.72 | |
| | <u>Carriage & royalties</u> | | | | | | |
| | K.B. Bricks (25cmx12cmx8cm size) | 350 | Nos | 1000 | 687.30 | 240.56 | |
| | | | | Nos | | | |
| | Sand for mortar | 0.28 | cum | cum | 183.84 | 51.48 | |
| | Cement | 0.501 | qntl | qntl | 16.90 | 8.47 | |
| | | | | | Total | 3895.22 | Per cum |
| 16 | Brick works with K.B. bricks having crushing strength between 100kg/sq.cm to 149kgsq.cm | | | | | | |
| | in C.M. (1:8) in super structure including cost, conveyance, royalties of all materials etc. all complete. | | | | | | |
| | | Rate of F&P.per cum. | | | | 3895.22 | |
| | | Add for super structure | | | | 33.00 | |
| | | | | | Total | 3928.22 | Per cum |
| | | | | | cess-1% | 38.93 | |

| | | | | | | | |
|-----------|---|--------|-------|-------|---------|---------|----------|
| | | | | | | 3928.22 | Per cum |
| 16 | 12mm thick cement plaster (1:6) over brick | | | | | | |
| | work including cost, conveyance, royalties of | | | | | | |
| | all materials etc. complete. | | | | | | |
| | <u>Material</u> | | | | | | |
| | Sand for mortar | 0.015 | cum | cum | 52.00 | 0.78 | |
| | Cement | 0.0358 | Qntl | Qntl | 714.00 | 25.56 | |
| | <u>Labours</u> | | | | | | |
| | Mason 2nd class | 0.14 | Nos | Each | 240.00 | 33.60 | |
| | Man mulia | 0.07 | Nos | Each | 200.00 | 14.00 | |
| | Female mulia | 0.05 | Nos | Each | 200.00 | 10.00 | |
| | | | | | A | 83.94 | |
| | O.H.C. 7.5% on (A) | | | | | 6.30 | |
| | CP. 7.5% on (A) | | | | | 6.30 | |
| | | | | | B | 96.53 | |
| | <u>Carriage & royalties</u> | | | | | | |
| | Sand for mortar | 0.015 | cum | cum | 183.84 | 2.76 | |
| | Cement | 0.0358 | Qntl | Qntl | 16.90 | 0.61 | |
| | | | | | Total | 99.90 | Per sqm. |
| | | | | | cess-1% | 1.00 | |
| | | | | | | 100.89 | Per sqm. |
| 17 | Cement washing two coats including cost, | | | | | | |
| | conveyance, royalties, etc. all complete. | | | | | | |
| | Data for 93 sqm | | | | | | |
| | <u>Material</u> | | | | | | |
| | Cement | 1.5015 | qntl. | qntl. | 714.00 | 1072.07 | |
| | <u>Labours</u> | | | | | | |
| | Painter (2nd class) | 1 | Nos | Each | 240.00 | 240.00 | |
| | Man mulia | 1.63 | Nos | Each | 200.00 | 326.00 | |
| | | | | | A | 1638.07 | |
| | O.H.C. 7.5% on (A) | | | | | 122.86 | |
| | CP. 7.5% on (A) | | | | | 122.86 | |

| | | | | | | | |
|-----------|--|--------|-------|----------------|---------|---------|----------|
| | | | | | B | 1883.78 | |
| | Carriage of cement | 1.5015 | qntl. | qntl. | 16.90 | 25.38 | |
| | | | | | | 1909.16 | |
| | | | | Rate for 1sqm. | | 20.53 | Per sqm. |
| | | | | | cess-1% | 0.21 | |
| | | | | | | 20.73 | Per sqm. |
| 18 | Finishing walls with water proofing cement paint | | | | | | |
| | of approved shade on new work two coats to give | | | | | | |
| | an even shade including cost of paint. | | | | | | |
| | Data for 10 sqm | | | | | | |
| | <u>Labours</u> | | | | | | |
| | Painter or polisher(special) | 0.22 | Nos | Each | 260.00 | 57.20 | |
| | Man mulia | 0.32 | Nos | Each | 200.00 | 64.00 | |
| | | | | | A | 121.20 | |
| | O.H.C. 7.5% on (A) | | | | | 9.09 | |
| | CP. 7.5% on (A) | | | | | 9.09 | |
| | | | | | B | 139.38 | |
| | Cost of cement paint | 2.5 | kg | kg | 46.00 | 115.00 | |
| | | | | | Total | 254.38 | |
| | | | | Rate for 1sqm. | | 25.44 | Per sqm. |
| | | | | | cess-1% | 0.25 | |
| | | | | | Total | 25.69 | Per sqm. |
| 19 | Priming 1 coat with any approved primer | | | | | | |
| | including cost of all labours and materials etc. | | | | | | |
| | all complete. | | | | | | |
| | Data for 9.3 sqm | | | | | | |
| | <u>Labours</u> | | | | | | |
| | Painter (special) | 0.5 | Nos | Each | 260.00 | 130.00 | |

| | | | | | | | |
|-----------|---|-------|-----|----------------|--------------|-----------------|----------|
| 20 | Painting 2 coats with any approved paint on new iron work | | | | | | |
| | including cost of all labours and materials etc. | | | | | | |
| | all complete. | | | | | | |
| | Data for 9.3 sqm | | | | | | |
| | <u>Labours</u> | | | | | | |
| | Painter (special) | 1.25 | Nos | Each | 260.00 | 325.00 | |
| | Man mulia | 1.10 | Nos | Each | 200.00 | 220.00 | |
| | | | | | A | 545.00 | |
| | O.H.C. 7.5% on (A) | | | | | 40.875 | |
| | CP. 7.5% on (A) | | | | | 40.88 | |
| | | | | | B | 626.75 | |
| | | | | Rate for 1sqm. | | 67.39 | |
| | Cost of paint | 0.125 | kg | kg | 190.00 | 23.88 | |
| | | | | Rate for 1sqm. | | 91.27 | Per sqm. |
| | | | | | cess-1% | 0.91 | |
| | | | | | | 92.17 | Per sqm. |
| 21 | <u>M-25</u> | | | | | | |
| | Data for 15 cum | | | | | | |
| | | | | | | | |
| | a) <u>Material</u> | | | | | | |
| | 20mm Chips | 8.10 | cum | cum | 1058.00 | 8569.80 | |
| | 10mm Chips | 5.40 | cum | cum | 1120.00 | 6048.00 | |
| | Coarse Sand | 6.75 | cum | cum | 49.00 | 330.75 | |
| | Cement | 6.05 | MT | MT | 7140.00 | 43197.00 | |
| | | | | | Total | 58145.55 | |
| | | | | | | | |

| | | | | | | | | |
|-----------|--------------------------------------|----------------|------|------|---------------------------------|-----------------|---------|--|
| b) | Labour | | | | | | | |
| | Mate | 0.86 | Nos. | Nos. | 220.00 | 189.20 | | |
| | Mason Second Class | 1.50 | Nos. | Nos. | 240.00 | 360.00 | | |
| | Man Mulia | 20.00 | Nos. | Nos. | 200.00 | 4000.00 | | |
| | | | | | Total | 4549.20 | | |
| C) | Machinery | | | | | | | |
| | Concrete mixture (cap0.40/0.28 cum) | 6.00 | hour | hour | 177.00 | 1062.00 | | |
| | Generator 33 KVA | 6.00 | hour | hour | 240.00 | 1440.00 | | |
| | | | | | Total | 2502.00 | | |
| | Total | (a+b+c) | | | | 65964.90 | | |
| | Overhead charges on 15 % (a+b+c) = | | | | | | 9894.74 | |
| | | | | | | 75859.64 | | |
| | Royalty & Carriage= | | | | | | | |
| | 13.5x347.18+6.75x183.84+6.05x169.00= | | | | | | | |
| | 4686.93+1240.92+1022.45= | | | | | 6950.30 | | |
| | | | | | Total | 82809.94 | | |
| | | | | | Rate per Cum=5520.66 | | | |
| | | | | | say Rs.5520.70 | | | |

| | | | | | | | |
|-----------|---|-------|------|------|--------------|----------------|--|
| 22 | PCC (1:2:4) | | | | | | |
| a | 12mm chips | 0.90 | cum | cum | 1100.00 | 990.00 | |
| | Sand | 0.045 | cum | cum | 49.00 | 22.05 | |
| | Cement | 3.23 | qtl | qtl | 714.00 | 2306.22 | |
| | | | | | Total | 3318.27 | |
| b | Labour | | | | | | |
| | Mason Second Class | 0.68 | Nos. | Nos. | 240.00 | 163.20 | |
| | Man Mulia | 4.60 | Nos. | Nos. | 200.00 | 920.00 | |
| | | | | | | 1083.20 | |
| c | Overhead charges & Contractor Profit @ 15% on (a+b) | | | | | 660.22 | |
| | | | | | | | |
| d | Carriage & Royalty | | | | | | |
| | 0.90 x 609.78 + 0.45 x 239.04 + 3.23 x 16 | | | | | 90.00 | |
| | 544.30 + 107.57 + 59.59= | | | | | 706.46 | |
| | | | | | Total | 5768.15 | |
| | | | | | Add 1 % Cess | 57.68 | |
| | | | | | | 5825.83 | |

Say, 5825.80 / cum

| Internal Road | | | | | | |
|----------------------|----------------------|---|--------------|-----|------------|----------------|
| For 1.0 mtr. | | | | | | |
| E/W - | 1.0 m x 3.5m x 0.3m | = | 1.05 | cum | | |
| | @ Rs. 129.70/cum | | | | Rs. | 136.19 |
| Sand filling | 1.0m x 3.5m x 0.15 m | = | 0.53 | cum | | |
| | @ Rs. 314.60/cum | | | | Rs. | 166.74 |
| PCC (1:3:6) | 1.0m x 3.5m x 0.15 m | = | 0.53 | cum | | |
| | @ Rs. 4451.30/cum | | | | Rs. | 2359.19 |
| M- 25 | 1.0m x 3.5m x 0.10 m | = | 0.35 | cum | | |
| | @ Rs. 5718.50/cum | | | | Rs. | 2001.48 |
| | | | Total | | Rs. | 4463.60 |

OPERATION AND MAINTENANCE ASPECTS OF SeTP / FSTP

Faecal sludge treatment plants (FSTPs) or Septage Treatment Plants (SeTPs) require ongoing and appropriate operation and maintenance (O&M) activities in order to ensure long-term functionality. O&M activities are at the interface of the technical, administrative, and institutional frameworks that enable sustained FSTP function. "Operation" refers to all the activities that are required to ensure that a FSTP / SeTP delivers treatment services as designed, and "maintenance" refers to all the activities that ensure long-term operation of equipment and infrastructure (Braustetter, 2007). Proper O&M of FSTPs / SeTPs requires a number of crucial tasks to be carried out regardless of the size of the plant, and complexity of the technological setup. Having skilled workers perform these tasks in a timely manner and in accordance with best practices will maximise the value of the FSTP / SeTP and ensure its long-term performance.

Many FSTPs / SeTPs fail following construction, regardless of the choice of technology or the quality and robustness of the infrastructure. Reasons for failure are not always investigated, but the most frequent explanations given are low operational capacity (Fernandes *et al.*, 2005; Lennartsson *et al.*, 2009; Kone, 2010; HPCIDBC, 2011), and the lack of financial means to accomplish O&M tasks (Kone, 2002). Lessons learned from these failures are that O&M must be considered as an integral component of the full life cycle costs of a facility, and that ongoing training and capacity building is essential for the operators. In addition, the O&M plan must be incorporated into the design process and receive appropriate review and approvals along with the engineering plans. This helps to ensure that O&M is fully integrated into the facility once construction is complete and operation has begun. Financial, technical and managerial inputs are needed to ensure the continuous operation of even the simplest of FSTP/SeTP systems. The procedures that establish how the treatment facility and equipment are utilised, are documented in several O&M plans, monitoring programmes, reports and log books, and health and safety plans, which outline the step-by-step tasks that employees are required to carry out in order to ensure the long-term functioning of the FSTP/SeTP. While many O&M activities are process specific, others are common to all facilities and all O&M Plans should therefore, include information on:

- the procedures for receiving and off-loading of faecal sludge (FS) at the FSTP/SeTP;
- the operation of specific technologies such that they function as designed;
- maintenance programmes for plant assets to ensure long-term operation and to minimise breakdowns;
- the monitoring and reporting procedures for the FSTP/SeTP O&M activities as well as the management of treatment end products;
- management of health and safety aspects for protection of the workers and the environment;
- the organisational structure, distribution of and the management of administrative aspects; and
- procedures for the onsite storage of FS and the off-site transportation.

The level of organisation required at any given FSTP/SeTP is a function of its size and treatment capacity. Small systems that receive a few loads of FS a week may only need one operator, and therefore have relatively simple O&M plans, while large municipal systems that receive FS loads around the clock are more complex and require more staff with different levels of operators and maintenance personnel. This chapter discusses the O&M planning process as well as the specific components of the O&M Plan. It references the procedures and tasks that are common to all FSTP/SeTP facilities, as well as considerations for technology specific tasks.

O&M Planning During Project Development Phase

There are several important factors that need to be considered when planning FSTPs / SeTPs which will have a direct impact on O&M and monitoring. They encompass both classical engineering aspects of technology integration, as well as other issues concerning the institutional management that defines the FSM programme. Since O&M aspects are important for the overall long-term success of the programme, O&M planning, including the financial provision of funds, should be included in the terms of references for the design of each FSTP (Fernandes *et al.*, 2005; Luthi, 2011). Furthermore, the O&M plan should be reviewed and approved along with engineering designs and specifications, including the following considerations:

- location of the FSTP and its proximity to residential areas;
- volumes and schedules of FS collection;
- availability of local resources;
- degree of mechanisation of technologies; and
- final end use or disposal of end products.

Location

The location of a FSTP is a crucial aspect when designing an O&M plan. FSTPs /SeTPs are often associated with nuisances such as odours, flies and mosquitoes, and noise. Facilities located close to residential areas must therefore install preventative controls, all of which have O&M implications. Examples include FSTPs/SeTPs that utilise waste stabilisation ponds located near to residential areas, where mosquito control is an important requirement. For FSTPs/SeTPs located such that access roads cross residential areas, reduction of noise and dust produced by trucks needs to be regulated.

Other site specific factors that might influence O&M activities and costs include:

- soil conditions, such as soil depth and bearing capacity, that might have impact on equipment selection and installation;
- groundwater level and proximity of the FSTP/SeTP that could result in pollution of water resources or infiltration of groundwater into treatment tanks, directly impacting on the pumping and solids handling equipment; and
- surface waters and flooding risks, which might inhibit site access during rainy seasons, adversely affect or undermine equipment due to scouring or erosion.

Volume

The volume of FS that is collected and delivered to the treatment plant, as well as the operational times of the FSTP/SeTP will have a significant influence on the O&M costs and requirements. Cultural habits or events can influence the volumes that are discharged at the FSTP/SeTP at different times of the year. Similarly, seasonal variability of waste volumes will impact O&M staffing requirements. Larger systems that operate on a daily basis have very different staffing requirements to those that operate intermittently.

The distribution of the FS volume received at the plant throughout the day is critically important in the planning process, as low or high flows that exceed the design of the treatment system can have a significant impact on the operational efficiency. The initial planning phase must therefore ensure that the chosen technology is appropriate for local conditions, and that it is correctly sized to accommodate the expected volumes and related fluctuations. Institutional arrangements that closely coordinate activities between facility owners and those responsible for the FS collection and transportation can help to address these issues.

Local Resources

The availability of local resources impacts not only those aspects that determine the cost of construction such as technology selection and building materials but also on the costs of O&M requirements. Local resource issues that must be considered from the O&M perspective include:

- the availability of spare parts and tools;
- the availability of consumables (e.g. chemicals for flocculation);
- the availability and reliability of local utilities including water and power;
- the availability of trained human resources to properly operate the facility;
- the availability of local laboratory resources that may be required for monitoring programs; and
- the availability of local contracting firms to assist with periodic tasks that may be labor intensive, or require very specific skills.

Ideally, equipment that can be maintained and repaired within the country should be used. If no local supplier is available, fast delivery and repair services need to be ensured, or adequate replacement components must be stocked at the plant. For example, the powerful vacuum trucks that are needed to empty settling-thickening tanks require specific maintenance skills, which are often not locally available in mechanical workshops. It is therefore recommended that contracts be prepared during the equipment acquisition process whereby conditions for the repair services, for example, the annual maintenance of vacuum trucks, is defined. When designing FSTPs/SeTPs that require the addition of consumables for the treatment process (e.g. lime or chlorine), the costs and availability of these needs to be assessed, as well as the requirements for safe storage. Other aspects that impact on O&M costs include emergency operation procedures during power or water outages, and any shipping or transportation charges for delivery of samples requiring laboratory analysis. The choice of technology should therefore not only be made based on installation costs, but also O&M costs.

Adoption of technology

The degree of mechanisation of the FSTP/SeTP depends on the availability of spare parts, electrical power and trained operators. Where this is limited, passive technologies such as drying beds and stabilisation ponds might be better technology choices which has been the case in this project. If power availability is intermittent, technologies that utilise manual systems should be chosen over mechanical ones whenever possible. For example, screenings can be removed manually or by a mechanical rake, dried sludge can be transported with a mechanical shovel or with a wheelbarrow, and small composting piles can be mechanically aerated, while compost heaps need to be turned manually. Provisions for such items are to be made in the O&M cost estimates.

End use or disposal

The end use or disposal of the treatment end products has an influence on the technologies and processes needed to achieve the required level of treatment. This in turn, has a significant impact on the costs and skill levels required to operate and maintain equipment. In a simple SeTP where sludge is dried for disposal in a landfill or for end uses such as combustion, both of which do not require high pathogen reduction, less rigorous treatment and lower O&M costs are involved compared to a system that produces end products for use on food crops that are directly ingested without cooking (e.g. salad greens). Determining if the value associated with the end use activities is outweighed by the technology and O&M costs needed to achieve the required levels of treatment is a key driver for SeTP technology design. Understanding the costs associated with the specific O&M and monitoring tasks for identified end use activities assists in the planning of a FSM programme.

O&M PLAN

This includes details on the tasks, materials, equipment, tools, sampling, monitoring and safety procedures which are necessary to keep the plant running properly, all of which have cost implications that must be carefully considered.

Operation Procedure

FSTPs require clear operational procedures. Therefore, the O&M plans should include an operation manual, containing the following information:

- the as-built engineering drawings and FSTP specifications;
- the manufacturer's literature and equipment operation guidelines;
- the responsible person for each task;
- the frequency of each activity;
- the operation procedures and tools required to perform the task;
- the safety measures required; and
- the information that is to be monitored and recorded.

If chemicals or other consumables are required for the operation of a specific component, they should also be listed together with the name of the supplier and information on how they are to be used and stored. If some operational activities require the use of external companies, or if a transport company is needed to discharge the end products, their contact and description should also be given in the operation manual. The operation manual must also have a special section for emergency or non-routine operations requirements. Procedures should be planned for specific cases such as extreme climatic events, power shortages, overload, degradation of a pump, basin or canal, and other accidents. All procedures provided in the operation manual must be prepared in order to ensure conformance with the local laws and standards. The treatment technologies require the control of the following aspects:

- screenings removal;
- load (quantity, quality and frequency);
- processing (e.g. mixing compost pile, chemical addition for mechanical drying);
- residence time;
- extraction, further treatment or disposal of end products;
- collection and further treatment or disposal of liquid end products; and
- storage and sale of the end products.

The operational procedures should take the climate and the other context-dependent variables into account. The drying time or retention time may vary greatly during intensive rain periods or droughts. Rain events may also increase FS volumes delivered to the FSTP if the onsite sanitation systems were not built adequately, due to runoff or a rise in the groundwater table. The operational activities at the FSTP can then be planned to take these aspects into account. For example, macrophytes of planted drying beds can be weeded during a dry season, when there is potentially less FS to treat, and there is a shorter drying time.

The operational procedure also needs to take the FS characteristics (e.g. viscosity, amount of waste, fresh or partly stabilised sludge), and the required level of treatment into account. The information collected through the monitoring system also needs to be considered in order to improve the operational procedure and planning. For example, the frequency of sludge extraction from a settling-thickening tank or from a waste stabilisation pond can be adjusted based on the observed quantity of sludge accumulated over time.

Maintenance Procedure

There are two main types of maintenance activities: preventative maintenance and curative maintenance. Well-planned preventative maintenance programs can often minimise curative interventions to emergency situations, which are frequently costlier and complex. Component breakdowns at FSTPs can result in wider system failure, or non-compliance. Therefore, each component at the FSTP has specific preventative maintenance requirements that need to be described in detail in a maintenance plan including the tasks, frequency of actions, and step-by-step procedures for accomplishing the tasks, including inspections. Physical inspections conducted at scheduled intervals are important, where operators look for specific indicators such as cracked wires broken concrete and discoloured and brittle pipes in order to identify preventative maintenance needs.

The maintenance plan should be guided by the local context, the climate, and the asset-specific monitoring information. Coastal FSTPs/SeTPs, for example may require more frequent painting and corrosion control due to the salt air compared to the same plant located inland. The task details include the equipment, tools and supplies needed to accomplish the task and the amount of time it should take to complete. Once completed, the task details should be entered into the equipment maintenance log book or database, along with any difficulties encountered. Frequent maintenance tasks include:

- corrosion control – scraping rust, painting metal surfaces, and repairing corroded concrete;
- sludge and coarse solids extraction from the basins and canals;
- repacking and exercising valves (i.e. locating and maintaining fully operational valves);
- oiling and greasing mechanical equipment such as pumps, centrifuges or emptying trucks; and
- housekeeping activities including picking up of refuse and vegetation control.

Other aspects of maintenance include establishment of a laboratory facility for close monitoring of treatment process. Since septage can be brought from various sources with varied degree of pre-stabilization, the operation shall need to be favourable to the sludge characteristics, the degree of treatment and the quality of end product. Similarly, record keeping, safety procedures and emergency procedures are also to be well defined in order to establish a standard in operation and meet any eventuality during any hazard or disaster.

A comprehensive manual on operating procedure and preventive maintenance shall be prepared by the agency executing the project and make it available to the maintenance engineer at the end preferable within three months from the completion of the project and during its trial run. The spare inventory details along with list of critical spares, if any, shall have to be listed and 40% stock procured in advance to meet any exigency.

A tentative requirement of manpower for operation and maintenance of the Faecal sludge / septage treatment plant is given in the table 4 below.

7. Cost of construction, operation and maintenance shall have to be worked out on the following items;

The economic cost calculation shall include;

- i. Cost of main structures of 20 years' durability.
- ii. Secondary structures of 10 years' durability.
- iii. Equipment and parts of 6 years' durability
- iv. Annual cost derived from above.
- v. Rate of interest per annum
- vi. Interest factor on main structures, secondary structures, and equipment
- vii. Total capital cost. (land cost may not be added in the analysis)
- viii. Cost of personnel for operation, maintenance and repair (details to be worked out)
- ix. Cost of material for operation, maintenance and repair (details to be worked out)
- x. Cost of power
- xi. Cost of treatment additives i.e. lime, chlorine etc.
- xii. Total operational cost
- xiii. Income from bio-gas (if utilised), income from fertiliser, income from effluent, tipping fees.
- xiv. Total income from the project.

Bhubaneswar Septage Treatment Plant O & M Annual Estimate

| Sl. No. | Category of Staff | No. | Rate / Annum | Salary / wages/ Annum (Rs.) |
|---------|---|------------|--------------|-----------------------------|
| 1 | Laboratory Asst. | 1 | 238,800.00 | 238,800.00 |
| 2 | Electrician | 0.1 | 222,000.00 | 22,200.00 |
| 3 | Pump operator | 2 | 222,000.00 | 444,000.00 |
| 4 | Plumber | 0.1 | 222,000.00 | 22,200.00 |
| 5 | Watchman/ security | 3 | 195,000.00 | 585,000.00 |
| 6 | Sweeper | 1 | 92,800.00 | 92,800.00 |
| 7 | Un-skilled worker | 1 | 92,800.00 | 92,800.00 |
| | Total | 8.2 | | 1,497,800.00 |
| | R/M of civil, electro-mechanical works @ 1.5% of c.w, i.e. Rs. 29023461.00 | | | 435352.00 |
| | Total | | | 1933152.00 |
| | O&M cost for 5 years | | | 9665760.00 |
| | Say Rs.95,65,800.00 | | | |

HYDRAULIC PROFILE OF TREATMENT COMPONENTS OF BHUBANESWAR SEPTAGE PLANT

(Data is subject to verification after detailed survey of work site during execution)

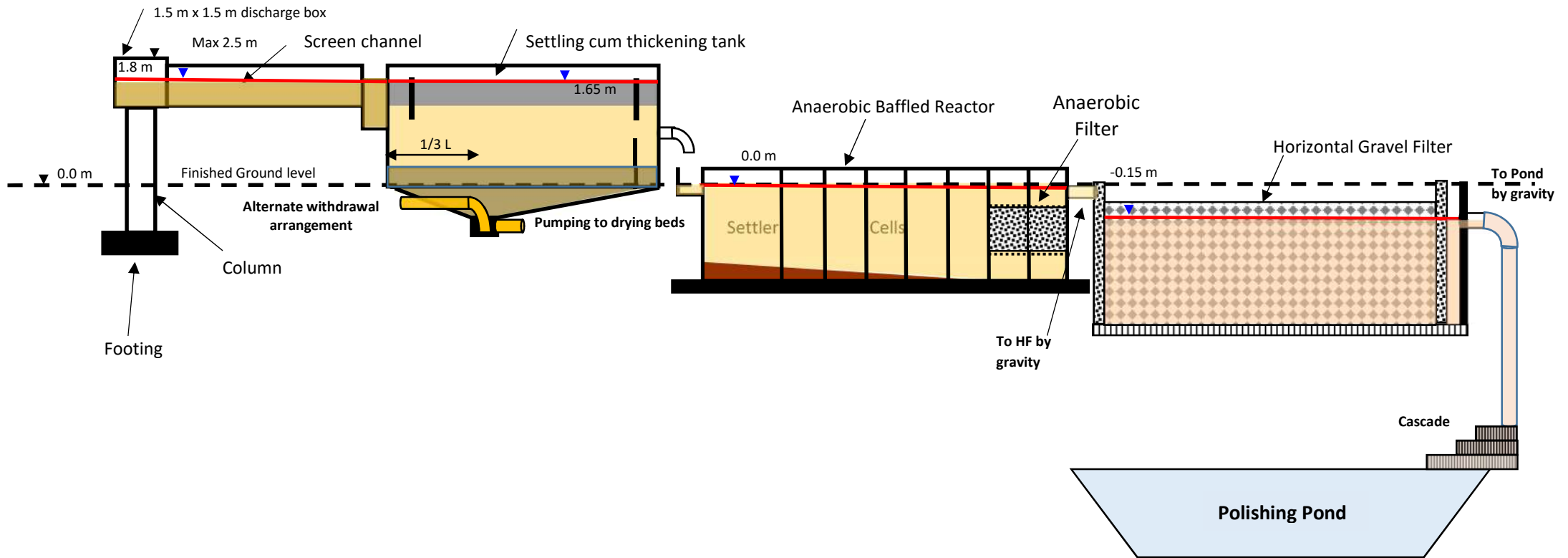

Settling cum thickening Tank

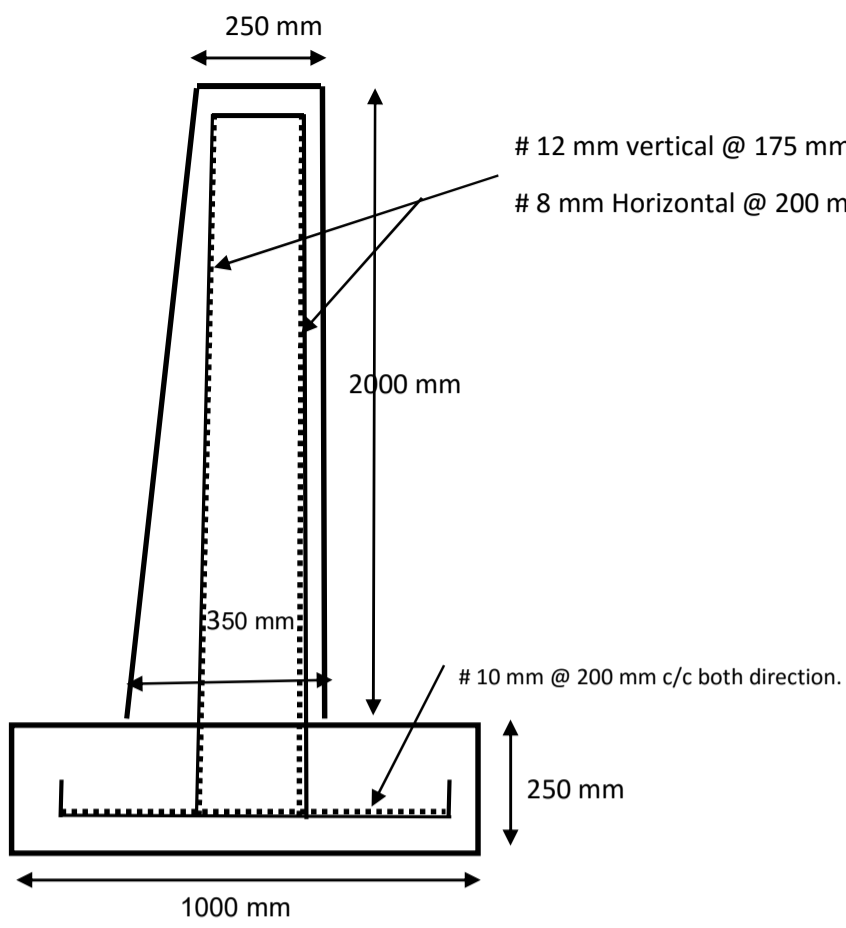

Long and short wall reinforcement

Anaerobic Baffled Reactor Tank

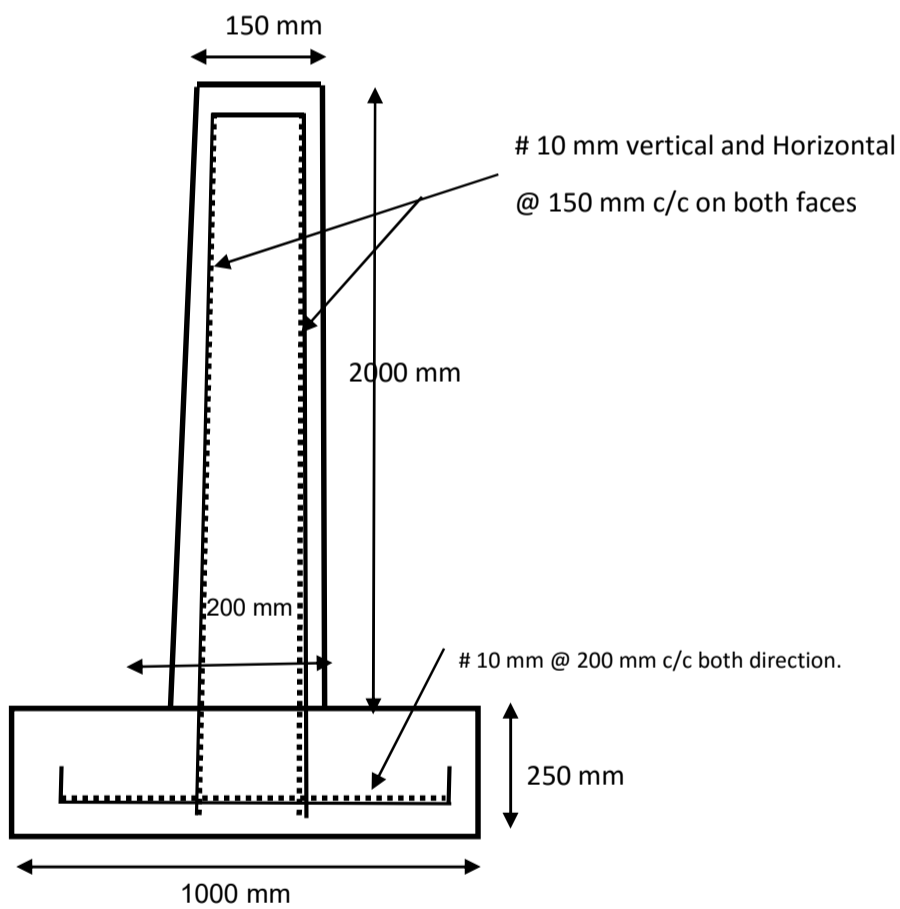

Long and short wall reinforcement

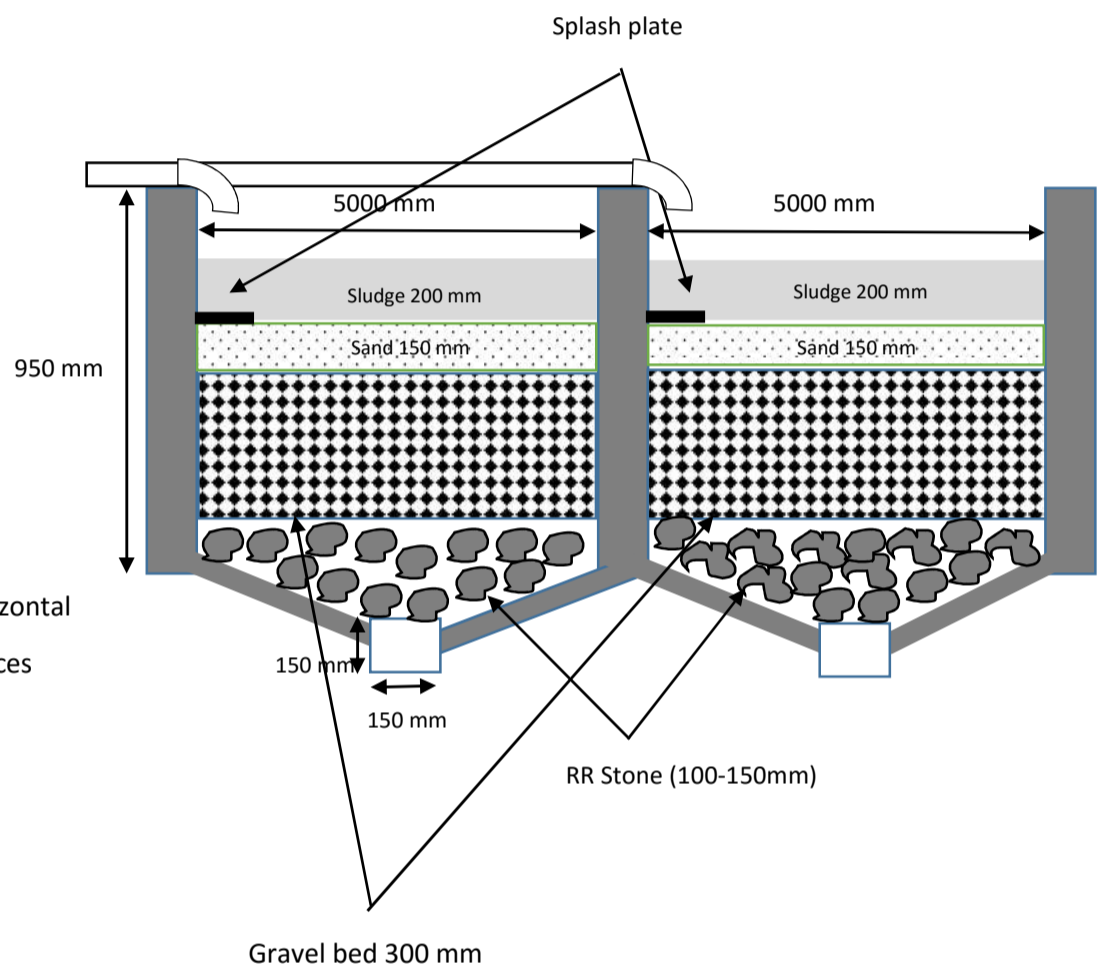
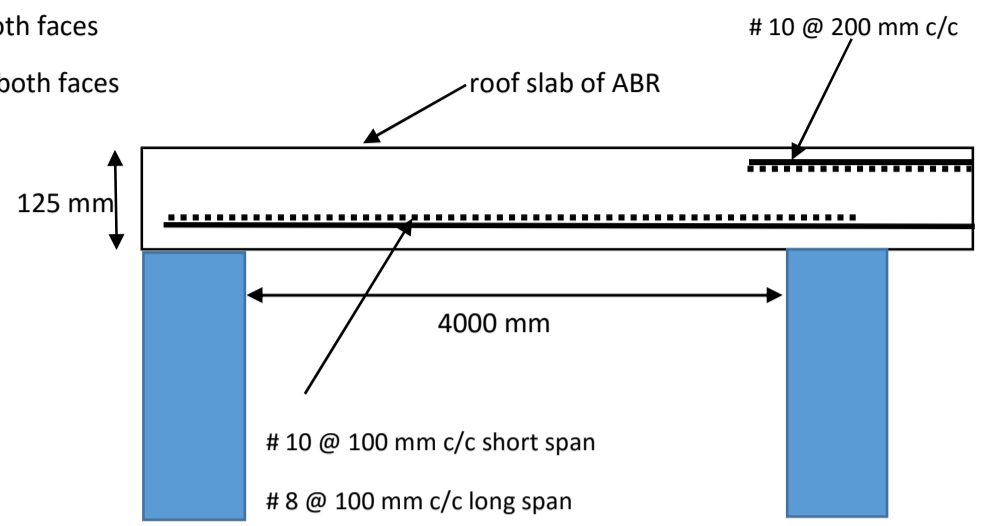

REED BED

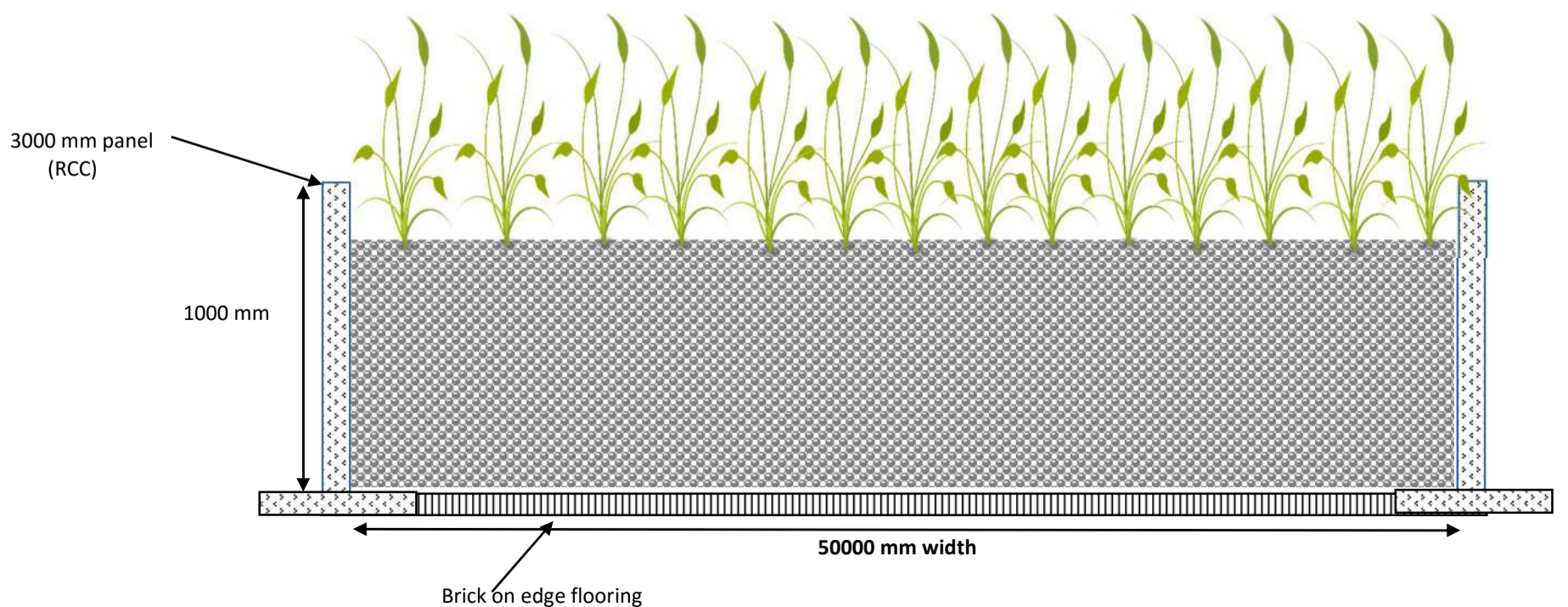



ORISSA WATER SUPPLY AND SEWERAGE BOARD

TECHNICAL BID

BID DOCUMENT

COVER- I

NAME OF WORK:

Construction of Septage Treatment Plant in Bhubaneswar City in Khordha District, Odisha

Last date of submission : Up to 05.00 P.M. on2016

NAME OF THE SCHEME:

Construction of Septage Treatment Plant in Bhubaneswar City in Khordha District, Odisha - Construction of Settling-thickening tanks, Sludge drying beds, Anaerobic Baffled Reactors, Horizontal planted gravel filter, Maturation pond, Filtrate sump, Security room, CC pavement, construction of compound wall around the treatment plant, Effluent disposal arrangement, Construction of Pump Room of 12 m², supply, delivery and installation of Non clog submersible pump sets, laboratory room, watch shed, administrative room etc. complete including Trial run for 3 Months (period of completion - 9 months)

LAST DATE OF SUBMISSION OF BID: Up to 5.00 PM on2016

CHECK LIST TO BE ENCLOSED BY BIDDER (along with Bid Documents)

NIB NO. / SeTP/2016

Dated:

The check list is only indicative to assist the bidder in satisfactorily enclosing all required major documents for Technical Qualification. The list is not exhaustive and the bidder should read all clauses of the bid document so as to enclose all documents as required:

A. BID SECURITY

- i) Bid security for a value of **Rs. 1.44 Lakhs** to be furnished
- ii) Furnish the details of Bid Security as under

| Sl. No. | Name of the Bidder | Amount and type of security | Issued by |
|---------|--------------------|-----------------------------|-----------|
| | | | |

B. ELIGIBILITY/QUALIFICATION CRITERIA

| Sl No | Description | Requirement as per Bid document | Particulars as furnished by the bidder | Page No. with Ref. no., if any, where the particulars are furnished by bidder. |
|-------|---|---------------------------------|--|--|
| | Financial Turnover & Cash flow. | | | |
| 1. | Average Annual Turnover for the last five financial years Rs. in Lakhs (2010-11, 2011-12, 2012-13, 2013-14 & 2014-15) –25% of BOQ value | 50 Lakhs | | |
| 2 | Net worth (10% of BOQ value) | 15.00 Lakhs | | |
| 3. | Minimum cash flow required in Rs. in LAKHS (10% of BOQ value) | 15.00 Lakhs | | |

| | | | | |
|-----|---|-------------------|--|--|
| 4 | The bidder should have satisfactorily completed at least one work Rs.in crores in a single contract in the last five years. | 72.00 | | |
| | (2010-11 to 2014-15) - 25 % of BOQ value. | Lakhs | | |
| 5. | Bid capacity: Assessed Available Bid capacity = $(A*N*1.5) - B$ | 144.00 Lakhs | | |
| 6 | Physical (Work Experience) Minimum aggregate during last five years 2010-11 to 2014-15 | | | |
| 6.a | Minimum aggregate experience of Pipe laying work during the last 5 years Supply, laying, jointing and testing of pumping main of any size of same materials i.e. HDPE pipes | 300 m | | |
| 6.b | Minimum experience –should have Constructed and commissioned a water retaining structure of capacity more than 25 m ³ along with piping arrangement. | 25 m ³ | | |
| | | | | |

BID DOCUMENTS**INDEX**

| Item No | Description of Work | Page No. |
|----------------|---|-----------------|
| I | Invitation for Bids | |
| II | Letter of Application | |
| III | Instructions to Bidders | |
| A. | GENERAL | |
| 1. | Scope of the Bid | |
| 2. | Method of Bidding. | |
| 3. | One Bid per Bidder | |
| 4. | Cost of Bidding. | |
| 5. | Site Visit | |
| B. | ELIGIBILITY / QUALIFICATION CRITERIA | |
| 6. | Eligible Bidder Special attention to Bidders | |
| 7. | Qualification of the Bidder | |
| | Special attention to Bidders | |
| C. | BID DOCUMENTS | |
| 8. | Contents of Bid Documents | |
| 9. | Clarification of Bid Documents | |
| 10. | Amendments to Bid Documents | |
| D. | PREPARATION OF BIDS | |
| 11. | Language of the Bid. | |
| 12. | Documents comprising the bid | |
| 13. | Bid Prices | |
| 14. | Currencies of Bid and Payment. | |
| 15. | Bid Validity | |
| 16. | Bid Security | |
| 17. | Compliance to Technical Design and Specifications. | |
| 18. | Formal and Signing of Bid | |
| 19. | Pre Bid Meeting | |
| E. | SUBMISSION OF BIDS | |
| 20. | Sealing and marking of Bids | |
| 21. | Deadline for submission of Bids | |
| 22. | Late Bids | |
| 23. | Modification substitution and withdrawal of Bids | |
| F. | BID OPENING AND EVALUATION | |
| 24. | Bid Opening | |
| 25. | Process to be Confidential | |
| 26. | Clarification of Bids | |
| 27. | Examination of Bids and determination of Responsiveness | |
| 28. | Correction of Errors | |
| 29. | Evaluation and comparison of Bids | |

G. AWARD OF CONTRACT

30. Award Criteria
31. Employers Right to accept any Bid and to Reject any or all Bids
32. Notification of Award
33. Registration with State Govt.
34. Performance Security
35. Signing of Agreement
36. Mobilization Advance
37. Forfeiture of performance Security

IV. PROGRAMME SCHEDULE

38. Project completion and Milestone
39. Programme Schedule/Rate of progress/Milestone
40. Penalty for Defective construction
41. Liquidated damages
42. Foreclosure of works

V. PAYMENTS AND RECOVERIES

43. Payment Schedule
44. Release of performance security and Retention amount
45. Recovery of money payable to OWSSB
46. Income Tax
47. Sales Tax
48. Excise duty
49. Fund contribution for manual workers
50. Price Adjustment

VI. LIST OF ANNEXURES AND CERTIFICATES**Annexures:**

- 1) Performance of the Bidder showing total monetary value of Civil Engineering work for the past Five years (Annexure-I)
- 2) Average Annual Construction Turnover (Annexure-II)
- 3) Experience in works of similar nature and Magnitude within a period of 5 years (Annexure-III)
- 4) Commitment of works on hand (Annexure-IV)
- 5) Works for which Bid already submitted (Annexure-V)
- 6) List of Equipment available with bidder (Annexure-VI)
- 7) Qualification/Experience of key personnel proposed for technical and administrative functions under this contract (Annexure-VII)
- 8) Sample Format for evidence of access to or availability of credit facilities (Annexure-VIII)
- 9) Details of Litigation if any(Annexure-IX)
- 10) Declaration by the bidder pertaining to blacklisting / debarment etc. (Annexure-X)
- 11) Details of components proposed to be sublet and Sub contractor involved (Annexure-XI)
- 12) Technical staff to be employed (Annexure-XII)

Certificates:

- 1) Signature of the proprietor or proprietress attested by the Notary Public.
- 2) Signature of all the partners/power of attorney attested by the Notary Public.
- 3) Registration of the firm, signature of the authorized person attested by the Notary public.
- 4) A copy of the listed power of attorney authorizing the signatory of the bidder.
- 5) Proof of registration of firm/company.
- 6) Audited Balance sheets.
- 7) Credit line certificate from Financial Institutions.
- 8) Income Tax clearance certificate.
- 9) Sales Tax verification certificate.
- 10) Certificate of performance issued by not less than the rank of Executive Engineer / Responsible person of the private organization.

VII GENERAL CONDITIONS OF CONTRACT

1. Definitions
2. Interpretations
3. Authority of Engineer In-charge
4. Sufficiency of Bid.
5. Priority of Contract Documents -
6. Secrecy of the Contract Documents
7. Instructions in Writing.
8. Commencement of Works
9. Reference Marks.
10. Supervision
11. Subletting of contract
12. Specification and Checks.
13. Custody and Supply of Drawings and Documents
14. Bill of Quantities.
15. Change in the Quantities
16. Additional Items
17. Order Book
18. Independent Inspection
19. Covering and Opening of Works
20. Temporary Diversion of Roads and Commencement of Work
21. Notice to Telephone, Railway and Electric Supply Undertaking
22. Watching and Lighting.
23. Measurement of Work.
24. Tools and Plants.
25. Information and Data
26. Co-existence with other Contractors.
27. General Responsibilities and Obligations of the Contractor
28. Labour
29. Restriction of Working Hours.
30. Right of Way and Facilities.
31. Removal of Improper Work. Material and Plant.
32. Default of contractor in Compliance.
33. Default by Contractor.
34. Power to vary Work.
35. Extra for Varied Works.
36. Omissions.
37. Notices regarding Shoring etc.

38. Cost of Repairs.
39. Suspension of Works.
40. Suspension of Progress.
41. Termination.
42. Plant etc. not to be removed.
43. Contractor not to occupy Land etc.
44. Power Supply.
45. Completion and Delivery of the Works.
46. Final Certificate.
47. Completion Certificate.
48. Taking Over
49. Performance Guarantee
50. Trial run of the Project
51. Operating and Maintenance Manual.
52. Work on Private Property.
53. Protection.
54. Accident or Injury to Workmen.
55. Risk Insurance.
56. Care and Risk
57. Safety Provisions
58. Provision of Health and Sanitary Arrangements.
59. Patent Rights.
60. Royalties.
61. Old Curiosities.
62. Contractor Dying, becoming Insolvent or Insane.
63. Force Majeure
64. Payment out of Public Funds
65. Bribery and Collusion
66. Technical Audit
67. Jurisdiction of Court
68. Reservation of Right

VIII SPECIAL CONDITIONS

1. Additional condition as per G.O. Ms 293 / MA&WS / dt: 26-11-2010

Letter of Negotiation.

Forwarding slip to Lump sum Agreement. Form of Agreement (Lump sum) Indemnity Bond.

Indemnity Bond (in lieu of water tightness and structural stability)

Performance Bank Guarantee (Unconditional)

Bank Guarantee for Advance Payment. Bill of Quantities.



ORISSA WATER SUPPLY AND SEWERAGE BOARD

TENDER CALL FOR SEPTAGE TREATMENT PLANT
FORM OF CONTRACT: (LUMP SUM TWO COVER SYSTEM)

INVITATION OF BID NO. ... /SeTP/2016

1. For and on behalf of Orissa Water Supply and Sewerage Board, bids (in Two-cover System) under lump sum contract are invited by the Member Secretary, OWSSB, as detailed below.
2. Bidding documents in English may be downloaded by interested bidders from the Government web site www.odisha.gov.in of Government of Odisha.
3. Cost of tender document is Rs.10000 + 5% VAT.
4. Amount of Earnest Money Deposit will be **1,50,000.00**.
5. Period of contract is as furnished below in respect of this work.
6. Pre Bid Meeting will be held **on** at **11.00** hours in Head Office of OWSSB at Satyanagar, Bhubaneswar.
7. Further details about work can be seen in bidding documents and can also be got from office of the Project Engineer, P.M. Unit, No-II, Bhubaneswar, OWSSB.

| Sl. No. | Name of the Work | Value put to Tender | Period of sale and contact person | Last date of submission of bids | Date and time of opening of technical bid |
|---------|--|---------------------|-----------------------------------|---------------------------------|---|
| 1 | 2 | 3 | 4 | 5 | 6 |
| 1 | Construction of Septage Treatment Plant in Bhubaneswar City in Khordha District, Odisha - Construction of Settling-thickening tanks, Sludge drying beds, Anaerobic Baffled Reactors, Horizontal planted gravel filter, Maturation pond, Filtrate sump, Security room, CC pavement, construction of compound wall around the treatment plant, Effluent disposal arrangement, Construction of Pump Room of 12 m ² , supply, delivery and installation of Non clog submersible pump sets, laboratory room, watch shed, administrative room etc. complete including Trial run for 3 Months (period of completion - 9 months) | | | | |

The undersigned reserves the right to reject any or all the bid documents without assigning any reasons therefore.

Member Secretary, OWSSB

Please visit our website www.odisha.gov.in for further details

II. Letter of Application

(Letter head paper of the Applicant, including full postal address, telephone no., fax no., cable address, and e-mail)

Dated

To

**The Member Secretary,
OWSSB, Satyanagar,
Bhubaneswar 751 007**

Dear Sir,

Being duly authorized to represent and set on behalf of

(hereinafter “the Applicant”),

and having reviewed and fully understood all the information provided, the undersigned hereby apply for consideration as a bidder for the following

IFB NO. / SeTP/2016.

Construction of Septage Treatment Plant in Bhubaneswar City in Khordha District, Odisha - Construction of Settling-thickening tanks, Sludge drying beds, Anaerobic Baffled Reactors, Horizontal planted gravel filter, Maturation pond, Filtrate sump, Security room, CC pavement, construction of compound wall around the treatment plant, Effluent disposal arrangement, Construction of Pump Room of 12 m², supply, delivery and installation of Non clog submersible pump sets, laboratory room, watch shed, administrative room etc. complete including Trial run for 3 Months (period of completion - 9 months)

Attached to this letter please find copies of original documents defining

- the Applicant’s legal status
- the principal place of business and
- the place of incorporation (for applicants who are corporation) or the place of registration and the nationality of the owners (for applicants who are partnerships or individually owned firms)

Your Agency and its authorized representatives are hereby authorized to conduct any inquiries or investigations to verify the statements, documents and information submitted in connection with this application, and to seek clarification from the bankers and clients regarding any financial and technical aspects. This ‘Letter of Application’ will also serve as authorization to any individual or authorized representative of any institution referred to in the supporting information, to provide such information deemed necessary and requested by yourselves to verify the statements and information provided in this application, or with regard to the resources, experience and competence of the Applicant.

This application is made in the full understanding that:

- bids by the applicants will be subject to verification of all information submitted for consideration, at the time of bidding.

Your Agency reserves the right to:

- amend the scope and value of any contract bid under this project

- and reject or accept any application, to cancel the entire bidding process and reject all the applications and
- Your Agency shall not be liable for any such action and shall be under no obligation to inform the Applicants of the grounds for them

It is hereby certified that the unit rates and price for all the items covered in the Bill of Quantities set out in the Price Schedule have been furnished clearly in figures and words and it is hereby agreed to execute the works at the rates and prices mentioned therein and to receive the payments on measured quantities as per the Conditions of the Contract.

It is hereby distinctly and expressly declared and acknowledged that before the submission of the bid, the instructions therein have been carefully followed and the conditions of the Contract and other terms and conditions have been read. It is also declared and acknowledged that careful examination of the bid documents has been carried out with reference to the specifications, quantities, location where the said work is to be done, investigation of the works to be done, materials required for this contract and their source and other requirements, covenants, stipulations and restrictions. It is distinctly agreed that no claim or demand will be made on OWSSB by the applicant, arising out of any misunderstanding or misconception or mistake of the said requirements, covenants, stipulations, restrictions, conditions etc. on the part of the applicant.

The Income Tax Clearance Certificate and Sales Tax Verification Certificate in currency are enclosed

The Bid Security of **Rs. 1.44 lakhs (Rupees Three lakhs and fifty thousand only)** is enclosed in the shape of

(Enter the form and other details of the bid security) drawn in favour of the **Project Engineer, P.M. Unit, OWSSB, Cuttack, Odisha.**

It is hereby agreed that in case the bid is accepted, the Performance Security to the value and in the manner/form prescribed by the Employer will be submitted and agreement entered into within the time frame stipulated for the due fulfillment of the contract. It is agreed that in the event of non-remittance of the required Performance Security and execution of the Agreement within the stipulated time frame, the Bid Security deposited with the bid will be forfeited. In the event of non-acceptance of the bid offered by the Applicant, the Employer shall intimate the applicant of the rejection of his bid, upon which the applicant can get his Bid Security refunded on an application for the same. Any notice required to be served on the applicant shall be deemed to have been sufficient if delivered personally or left at the address given herein or sent by post either by registered mail or ordinary. Such notice shall, if sent by post shall be deemed to have been served on the applicant at the time when in due course of post it would be delivered at the address to which it is sent. For all purposes, the address given herein will serve as permanent address and any change therein will be promptly intimated then and there.

It is fully understood and agreed that on receipt of communication of acceptance of the bid from the accepting authority, there emerges a valid contract between the Applicant and OWSSB represented by the officer accepting the bid and it is expressly agreed that the bid documents with the schedules, conditions of the contract, negotiation communications and other correspondence connected to this contract will all constitute the contract for this purpose and be the foundation of rights on both the parties.

It is agreed that time shall be considered as the essence of this contract and the work will be commenced immediately on getting information of the acceptance of the bid and any slow progress will be subjected to the relevant penal clauses contained in the Conditions of the Contract

It is hereby agreed that the professionally qualified personnel to execute and supervise the works shall be deployed as required in clause 10 of General Conditions of Contract.

The Applicant hereby agrees to undertake full responsibility for the stability and soundness of the works executed.

The Applicant hereby agrees that the bid will not be withdrawn during the period of validity as indicated in the bid documents and also during such extended periods agreed to by the applicant The Applicant agrees that in the event of withdrawal of the bid during the validity period or extended period, the Bid Security is liable to be forfeited by Employer.

It is explicitly understood that the Employer is not bound to accept the lowest or any bid the Board may receive. It is hereby agreed that the Employer reserves the rights to reject any or all the bids without assigning any reasons therefor.

Dated this day of
Month of

Signature of the Applicant
(To be signed by the
authorized signatory with seal)

NAME OF WORK

Construction of Septage Treatment Plant in Bhubaneswar City in Khordha District, Odisha - Construction of Settling-thickening tanks, Sludge drying beds, Anaerobic Baffled Reactors, Horizontal planted gravel filter, Maturation pond, Filtrate sump, Security room, CC pavement, construction of compound wall around the treatment plant, Effluent disposal arrangement, Construction of Pump Room of 12 m², supply, delivery and installation of Non clog submersible pump sets, laboratory room, watch shed, administrative room etc. complete including Trial run for 3 Months (period of completion - 9 months)

III. INSTRUCTIONS TO BIDDERS**A. GENERAL****1. Scope of the Bid**

This is a "Procurement, Construction Contract" and the contractor is responsible for the execution of the work including the supply and installation of all materials, machineries, equipment etc. in accordance with the specifications stipulated in the Bid Document and in conformity with the Quality Parameters laid down in the relevant BIS, CPHEEO, Bid Documents etc. and completing the entire work in all respects satisfactorily and commissioning within the stipulated period.

1.1 The Member Secretary, OWSSB, Bhubaneswar (hereinafter referred as "Employer" in these documents) invites bids for the construction of works (as defined in these documents and referred as "the works") as detailed in the Bill of Quantities. The bidder shall offer their/his price for all the items of works detailed in the Bill of Quantities.

Construction of Septage Treatment Plant in Bhubaneswar City in Khordha District, Odisha - Construction of Settling-thickening tanks, Sludge drying beds, Anaerobic Baffled Reactors, Horizontal planted gravel filter, Maturation pond, Filtrate sump, Security room, CC pavement, construction of compound wall around the treatment plant, Effluent disposal arrangement, Construction of Pump Room of 12 m², supply, delivery and installation of Non clog submersible pump sets, laboratory room, watch shed, administrative room etc. complete including Trial run for 3 Months (period of completion - 9 months)

Salient Details**Capacity of Treatment Plant: 50 m³/day****1. Screen Channel: 2 nos**

Size: 0.6 m (0.3 m SWD) x 3.0 m

Bar screen: Bar screen 1 m wide x 1 m depth – MOC: SS 316

Angle of placement to horizontal 45°, placed on a support channel for easy maintenance

One header sludge discharge box of 1.5 m x 1.5 m RCC

2. Settler-cum-thickener: 2 nos.

L x B x D = 12 m x 2 m x 2.6 m (depth at outlet)

Bottom slope 1% reverse.

Pump / sludge pit size 1000 mm x 1000 mm

3. **SLUDGE DRYING BED:No. of Beds: 10 nos.**
Size of each bed: 4.00 m x 15.00 m
4. **Anaerobic Baffled Reactor: 2 nos.**
Dimension: 13000 mm x 4000 mm x 2000 mm (1750 mm SWD)
Settler size: 5000 mm x 4000 mm
Up-flow reactor chamber size: 1175 mm x 4000 mm x 1750 mm SWD
5. **HORIZONTAL PLANTED GRAVEL FILTER (HPGF): 1 no**
Area: 1200 m² (40 m x 30 m)
Slope: 1%, depth at entrance: 0.6 m
6. **Maturation Pond: 1 no**
Pond area = 45 m², size: 6 m x 7.5 m
Pond depth = 1.0 m
7. **Leachate Sump: 1 no**
Diameter: 2.5 m
Depth: 4.0 m
8. **Pump Sets:**
 - a. **Submersible pump at maturation pond: 2 nos.**
Capacity: 3 - 5 kW
 - b. **Sludge pump at Thickener: 2 nos.**
Capacity: 7.5 kW
 - c. **Submersible at leachate sump: 2 nos.**
Capacity: 5 kW
9. **Pump rooms, Laboratory,
Watch shed, Administrative block: 85 m²**
10. **Electrical sub-station of 25 kVA capacity: 1 no**
11. **Open shed for co-composting: 200 m²**
12. **Construction of BT/CC road / pavement inside plant: 1 km**
13. **800 mm size production well: 1 no.**

14. Overhead water tank of 7,500 litres capacity.

15. Piping work of HDPE / DI material:2000 m

16. Yard Lighting and compound wall of 330 m

17. Site development, plantation and land scaping

1.2 Trial run of the Scheme (After successful commissioning of the project) – 3 Months.

1.3 The successful bidder will be expected to complete the works within the period stipulated for completion in the programme schedule.

1.4 In these bidding documents, the terms bid and tender and their derivatives (bidder / Bidder, bid/tender, bidding/tendering etc) are synonymous.

1.5 Downloading the documents from web site.

The documents are to be downloaded from the web site: www.odisha.gov.in by the Bidder and offer their tender duly filled and signed along with all required documents to the tender inviting authority as notified in the IFB subject to the following.

- a) The bidder shall furnish a certificate to the effect that no correction/ alteration on the bid document as found in the web site was made by him and he shall abide by all the terms, conditions and specifications contained in the bid document.
- b) Cost towards bid document shall be required to be paid by the bidders who are using the forms downloaded from the designated website.

The bidder shall submit the tender to the tender inviting authority as prescribed in the IFB.

2. Method of Bidding

2.1 If the bid is made by an individual, the bid documents shall be signed by the individual with his full name and current address.

2.2 If the bid is made by a proprietary concern, the bid documents shall be signed by the proprietor with his full names as well as the name of the firm and full address. In the case of an authorised person holding power of attorney signing the bid documents, a certified copy of the registered power of attorney should accompany the bid documents. The signature of the proprietor shall be attested by a notary public and enclosed as documentary evidence.

2.3 If the bid is made by a partnership firm, the bid documents shall be signed by all the partners of the firm along with their full names and current address with specific mention on the registered address of the firm. In the case of a partner holding power of attorney signing the bid documents, a certified copy of the registered power of attorney should accompany the bid. It is also mandatory to furnish a certified copy of the registered partnership deed, current address of the partners, registered address of the firm along with the bid. The signature of all the partners/ power of attorney shall be attested by a notary public and enclosed as a documentary evidence.

2.4 If the bid is made by a limited company or a limited corporation, it shall be signed by a duly authorised person holding power of attorney for signing the bid documents in which case a certified copy of the registered power of attorney shall accompany the bid. Such limited company or corporation may be required to enclose satisfactory evidence of its existence along with the bid.

2.5 The bids from the contractors / firms shall be accompanied by an attested copy of the Income Tax Clearance Certificate and Sales Tax Verification Certificate relating to the year prior to the previous financial year.

3. One Bid per Bidder

3.1 Each bidder shall submit only one bid for the whole scheme and in the case of packages, only one bid for a package. A bidder who submits or participates in more than one bid (other than sub-contractors) will be disqualified.

4. Cost of Bidding

4.1. The bidder shall bear all the costs associated with the preparation and submission of his bid. The Employer will in no case be responsible for those costs, regardless of the conduct or the outcome of the bidding process.

5. Site Visit.

5.1. The bidder, at the Bidder's own responsibility and risk is advised to visit and examine the site of works and its surroundings and obtain on his own all information that may be necessary for preparing the bid and entering into contract for the construction of the works. The costs of visiting the site and its surroundings shall be at the bidder's expense. Site levels, Soil data made available are only for the information of bidder and the employer is not responsible for their correctness.

5.2 The bidder and any of his personnel or agents will be granted permission by the Employer to enter upon its premises and lands for the purpose of such visit, but only upon the express condition that the bidder, his personnel or agents, will release and indemnify the Employer and his personnel or agents from and against all liability in respect thereof, and will be responsible for death or personal injury, loss of or damage to property, and any other loss, damage, costs and expenses incurred as a result of the inspection.

5.3 The bidder should carefully inspect the site to assess the prevalence of differing soil classifications and quote the rate for trench excavation for laying pipeline taken into account of all soil classifications that are likely to be encountered and no extra rate will be paid for excavation of trench on account of any variation in the classification of soil met with during actual execution

B. Eligibility / Qualification Criteria

6. Eligible Bidders

- 6.1 The Invitation to Bid is open to any bidder meeting the following requirements:
- 6.2 A bidder shall not be associated nor has been associated in the past, directly or; indirectly, with the Consultant or any other entity that has prepared the design, specifications and other documents for the project.
- 6.3 A bidder shall not be associated directly or indirectly with the firm engaged by the Board for providing consultancy services for the preparation and supervision of the works and any of its affiliates.
- 6.4 Bidders shall provide such evidence of their continued eligibility satisfactory to the Employer as the Employer shall reasonably request.
- 6.5. Joint Venture will not be accepted.

7. Qualification of the Bidder

7.1 General

- 7.1.1 Bidders shall provide the following as part of their bid in the prescribed formats.
- 7.1.2 A registered power of attorney authorizing the signatory of the bid to commit on behalf of the bidder should be enclosed.
- 7.1.3 Proof of registration of the firm/company under companies Act should be enclosed.
- 7.1.4 Total monetary value of Civil Engineering works performed during each of the last Five years should be furnished in Annexure – I.
- 7.1.5 Annual turnover (Civil Engineering works) for the past Five financial years (Audited balance sheet for the last Five financial years) should be enclosed. Annual turnover for the past Five financial years should be certified by a registered Chartered Accountant and the certificate should be affixed with the seal of the office of the Chartered Accountant with the registration number legibly in Annexure – II.
The contract receipt / contract income of the audit profit and loss account or audited income and expenditure account shall only be considered for the purpose of annual Turnover (Civil Engineering Works) for the past Five financial years.
- 7.1.6 Experience in works of similar nature and magnitude during each of the previous Five financial years, the details of works on hand and works for which bid already submitted should be furnished in the Annexure – III, IV and V respectively.
- 7.1.7 List of equipment available with the bidder for deployment in the project should be furnished in Annexure – VI.
- 7.1.8 Technical, administrative and managerial personnel proposed to be employed for key site management in this work with their qualification details should be furnished in Annexure – VII.

- 7.1.9 Evidence of access to lines of credit and availability of other financial resources, Credit line certificates from financial institutions should be enclosed in Annexure – VIII.
- 7.1.10 Litigation details of the bidder with the details of the parties concerned and the amount involved should be furnished in Annexure – IX.
- 7.1.11 The bidder should declare clearly whether the bidder has been black listed, banned or debarred in Central or any other State Government / Union Territory / Public Sector undertaking (State/Central) organization in Annexure – X.
- 7.1.12 Deleted
- 7.1.13 Income Tax Clearance Certificate in currency as proof of having remitted the income tax for the year prior to the previous financial year (with reference to the year in which the bid is opened)
- 7.1.14 Sales Tax Verification Certificate as proof of having remitted the sales tax. In the case of not liable to the Sales Tax Department, a valid certificate issued by the competent authority to this effect.

Conditions to be satisfied:**7.2 Performance Eligibility:****a) Financial & Physical capacity:**

| Sl. No. | DESCRIPTION | CRITERIA |
|----------------|--|-----------------|
| | Financial Turn over and Cash Flow | Rs.in Lakhs |
| 1. | Average Annual Turnover for the last five financial years Rs. in Lakhs (2010-11, 2011-12, 2012-13, 2013-14 & 2014-15) –25 % of BOQ value | 50 Lakh |
| 2 | Net worth (10% of BOQ value) | 15.00 Lakh |
| 3. | Minimum cash flow required in Rs. in Lakhs (10% of BOQ value) | 15.00 Lakh |
| 4 | The bidder should have satisfactorily completed At least one work Rs.in Lakhs in a single contract in the last five years. (2010-11 to 2014-15) | 72.00 Lakh |
| 5. | Bid capacity Assessed Available Bid capacity = (A*N*1.5) – B | 144.00 Lakh |
| 6 | Physical (Work Experience) Minimum aggregate during last five years 2010-11 to 2014-15 | |
| 6.a | Minimum aggregate experience of Pipe laying work during the last 5 years Supply, laying, jointing and testing of pumping main of any size of same materials i.e. HDPE / DI pipes | 300 m |
| 6.b | Minimum experience –should have Constructed and commissioned sewerage Treatment plant at least one secondary stage /industrial waste water treatment plant of capacity not less than 0.5 mld | 0.5 mld |
| 6.c | Minimum capacity of pump set should have supplied, erected and commissioned one pump set during the last 5 years | 10 KW |

Note : In addition to the above requirements the following criteria also to be satisfied.

BID CAPACITY

Bidders who meet the minimum qualification criteria will be qualified only if their available bid capacity is more than the total bid value. The available bid capacity will be calculated as under

Assessed Available Bid Capacity = $[A*N*1.5-B]$

Where A = Maximum value of civil engineering works executed in any one year during the last three financial years [updated to 2015-16 (current) price level @ 6.00% per annum] taking into account the completed as well as works in progress.

N = Number of years prescribed for completion of the works for which bids are invited i.e. Nine Months.

B = Value of existing commitments and on-going works to be completed during the next One year. [Updated to 2015 – 16 (Current) Price Level]

7.3 In order to prove that the Goods offered are of acceptable quality and standard, the bidders shall furnish documentary evidence that the Goods offered have been in production and similar capacity have been sold, as indicated in the table below. **Further documentary evidence to establishment the manufacturers credential including the certificate from the manufacturing company's Auditor is requested to be submitted along with the bid.**

| Item | Goods | Manufacturer's Experience Criteria | |
|------|--|---|---|
| | | Minimum No. of years preceding the due date of tender the goods offered are in production | Minimum average units sold per year |
| 1 | Pumps, Electrical & Mechanical equipment | | |
| 1.1 | Pumps: | | |
| | Submersible Pump | 5 | 50 Units |
| 1.2 | Electrical Transformer | | |
| 2 | Valves | | |
| | Above 200 mm size | 5 | 200 Units** |
| 3 | Electromagnetic / Ultrasonic Flow Meter, Electronic and ICA Equipment. | 5 | Endress and Hauser / Siemens / ABB / Krohne-Marshall or equivalent to ISI |
| 4 | Pipes | | |
| 4.1 | PVC pipes | 5 | 200% of total length required (KM) |

Pump sets: Pumpset with ISI specifications of reputed brands, such as Jyothi, Kirloskar, Best & Crompton, Calama, waterman, Atlanda, KSB, Texmo, CSI , or equivalent.

** Valves: Valves with ISI Specifications of reputed brands, such as Kirloskar, Venus, Upadyaya, CALSONS, Endress and Hauser / Siemens / ABB / Krohne - Marshall or equivalent

Unless otherwise stated in the Contract, the Accepted Contract Amount covers the entire Contractor's works under the Contract (including those under Provisional Sums, if any) and all things necessary for the proper design, installation, test, commission and trial operation of the Works. The Accepted Contract Amount shall cover the Works and the re-modifying of any defects.

Note:

- i. The performance eligibility shall pertain to the similar works executed by the tenderer in any of the Central / State Government Departments/Quasi Government Organizations and Government Undertakings, a Private Organization. The performance experience for Central / State Government Department / Undertaking / Quasi Government Organization should be supported by performance certificates issued by the concerned organization by an officer not less than the rank of Executive Engineer. **The experience certificates issued by an officer below the rank of Executive Engineer or on behalf of Executive Engineer will not be considered.**

In case of experience of a Private Organization, the following criteria should be satisfied:

- a) **The Photographs of the works undertaken for the Private Organization should be enclosed as a proof.**
 - b) **The certificate of the work done for the Organization be enclosed by a Senior Official who should be at least of the rank of the General Manager or Equivalent.**
 - c) **The above certificate should be countersigned by a Government Department Engineer at least of the rank of Assistant Executive Engineer and should also be Notarized.**
- ii. For the experience certificates furnished by the bidders which are obtained from the Departments outside the State, clarification will be obtained by the Employer from the concerned Department whenever felt necessary as to whether the details furnished in the certificates are genuine, before finalization of evaluation.
 - iii. The bills / claims should be prepared by the contractor as per Agreement and in accordance with the agreement executed and submitted to the Department
 - iv. Sub contractors' experience for the particular works to be sublet **shall not be taken into account for arriving at the eligibility of the contractor / firm.**
 - v. The tenderer should enter into proper agreement with sub-contractor proposed to be sub-let and furnish the documentary evidence along with bid.

Special Condition:

In case if a contractor/firm worked as sub-contractor previously, then their experience in those particular components of work will be considered only if their sub contract/sublet **work was properly approved by the User Department**. A certified copy to that effect from Engineer in charge (not below the rank of Executive Engineer) must be produced for arriving at the performance eligibility for the particular work to be sublet.

7.4. Disqualification:

Even though the bidders meet the above qualifying criteria, they are subject to be disqualified at any point of time if they have

- i) made misleading or false representation in the form statements and attachments submitted and/or
- ii) Record of poor performance during the last 5 years as on the date of application such as abandoning the work rescinding of contract for which the reasons are attributable to the non-performance of the Contractor inordinate delays in completion, consistent history of litigation awarded against the applicant or any of its constituents or financial failure due to bankruptcy etc.
- iii) been debarred / blacklisted as on the date of application by any Central/State Government Department/Undertaking/Organization and their bid will not be taken up for evaluation.

SPECIAL ATTENTION TO BIDDERS:

- I. Copies of experience certificates obtained from the Officer not below the Rank of **Executive Engineer** of respective user departments must be attested by Notary Public and produced.
- II. These Certificates should contain the following details
- 1) Name of Scheme (Name of the State also to be specified)
 - 2) Contract No. and date :
 - 3) Value of contract : Rs.
 - 4) Name of contractor with full address :
 - 5) Period of completion as specified in the contract :
 - 6) Date of commencement of work :
 - 7) Actual date of completion/ commissioning :
 - 8) Reason for the delay if any :
 - 9) Full details of components executed under this contract :

10) Performance of the work should contain the following:

| <u>Component</u> | <u>Performance</u> |
|--|--|
| i) In case of I.W / Collection well / intake well/Jack well/Foot Bridge/ Off take Well | : Whether completed and commissioned satisfactorily? |
| ii) In case of pipeline work (Type of each pipe with dia, length, pressure must be given) | : Whether completed and commissioned satisfactorily? |
| iii) In case service reservoirs (with capacity of S.Rs. to be clearly Mentioned) | : Whether constructed and commissioned satisfactorily? |
| iv) In case of pumping Machinery installed (The capacity of K.W. must be given) | : Whether commissioned satisfactorily? |

v). In case of Water Treatment Plant
(capacity in _____ MLD type
components)

: Whether completed and commissioned
satisfactorily.
:

Signature of Officer with Seal

C. BID DOCUMENTS

8. Contents of Bid Documents

8.1 The Bid Documents will comprise the following documents and addenda issued in accordance with clause 10 below:

Invitation for Bids Instruction to Bidders

Eligibility/Qualification Criteria Forms of Bid

Programme Schedule and financial mile stone. Payment Schedule

General Conditions of the Contract Special Conditions of

Contract Forms of Agreement

Indemnity Bond

Forms of performance Bank Guarantee (Unconditional). Forms of Bid security (Bank Guarantee)

Technical Specifications Bill of Quantities

Drawings

9. Clarification of Bid Documents.

9.1 A prospective bidder requiring any clarification may raise the same at the time of pre bid meeting in writing or by cable (hereinafter the term cable is deemed to include telex and facsimile) at the employer's address indicated in the invitation for bid. The employer will respond to any clarification sought for.

10. Amendment to Bid Documents

10.1 At any time prior to 48 hours to the deadline for submission of bids, the Employer may amend the bid documents by issuing Addenda.

10.2 Any Addendum thus issued shall be part of the bid documents and shall be communicated in writing or by cable to all purchasers of the bid documents. Prospective bidders shall promptly acknowledge the receipt of each addendum by cable to the Employer.

10.3 To give prospective bidders reasonable time in which to take an addendum into account in preparing their bids, the Employer shall extend as necessary the deadline for submission of bids, in accordance with Clause 21.2 of "Submission of Bids".

D. PREPARATION OF BIDS

11. Language of the Bid

11.1 The bid, and all correspondences and supporting documents related to the bid exchanged by the bidder and the Employer shall be written in English. Supporting documents and printed literature furnished by the bidder may be in other language provided they are accompanied by an accurate translation of the relevant passages in English language, in which case, for purpose of interpretation of the bid, the translation shall prevail.

12. Documents comprising the Bid

12.1 The bid submitted by the bidder shall comprise the following:

Cover – 1 (Technical Bid)

i. The Bid Documents duly filled and signed.

ii) List of Annexures

- a) Performance of the Bidder showing value of Civil Engineering work for the past Five years – (7.1.4) **Annexure - I**
- b) Average Annual Construction Turnover (Civil engineering work) for the last Five financial years – (7.1.5) **Annexure - II**
- c) Experience in works of similar nature and Magnitude within a period of 5 financial years – (7.1.6) **Annexure - III**
- d) Commitment of works on hand – (7.1.6) **Annexure - IV**
- e) Works for which Bid are already submitted – (7.1.6) **Annexure - V**
- f) List of Equipment available with Bidder – (7.1.7) **Annexure - VI**
- g) Qualification/Experience of key personnel proposed for technical and administrative functions under this contract – (7.1.8) **Annexure - VII**
- h) Sample Format for evidence of access to or availability of credit facilities – (7.1.9) **Annexure - VIII**
- i) Details of Litigation – (7.1.10) **Annexure - IX**

- j) Declaration by the bidder – (7.1.11) **Annexure - X**
- k) Details of components proposed to be sublet and sub-contractors involved – (7.1.12) **Annexure - XI**
- l) Technical staff to be employed (Para 10 of General Conditions) **Annexure - XII**

iii. List of Certificates.

- a) Signature of the proprietor or proprietress attested by the Notary Public (2.2)
 - b) Signature of all the partners/power of attorney attested by the Notary Public – (2.3)
 - c) Registration of the firm, signature of the authorised person attested by the Notary Public – (2.4)
 - d) A copy of the listed power of attorney authorising the signatory of the bidder – (7.1.2)
 - e) Proof of registration of firm/Company (7.1.3)
 - f) Audited Balance Sheets – (7.1.5)
 - g) Credit line Certificate from Financial institutions – (7.1.9) (Format-VIII)
 - h) Income Tax Clearance Certificate – (7.1.13)
 - i) Sales Tax Verification Certificate – (7.1.14)
 - j) Certificate of performance issued by not less than the rank of Executive Engineer of the organization concerned/responsible person of the private organization – (7.3)
- iv) Bid Security
- v) Any other material required to be completed and submitted by the bidders in accordance with these instructions.

Cover – II (Price Bid)

- 12.2 Priced Bill of Quantity duly signed.

12.3 The Bid should be submitted only in the original documents as issued by the Employer (or) as downloaded from the website. No alteration or correction should be made under any circumstances in the Bid Documents issued by the Employer (or) as downloaded from the website.

12.4 Conditional tenders are liable for rejection.

13. Bid Prices

13.1 The contract shall be for the whole works as described in sub clause (1.1), based on the priced bill quantities submitted by the bidder.

13.2 The bidder shall fill in rates and prices and line item total (both in figures and words) for all items of works described in the Bill of quantities along with total bid price (both in figures and words). Items for which no rate or price is entered by the bidder will not be paid for by the employer when executed and shall be deemed covered by the other rates and prices in the bill of quantities. Corrections, if any, shall be made by crossing out, initialing,

13.3 All duties, taxes and other levies payable by the contractor, under the contract or for any other cause shall be included in the rates, prices and total bid price submitted by the bidder.

13.4 The rates and prices quoted by the bidder are subject to adjustment during the performance of the contract in accordance with the provisions of clause 51.

14. Currencies of Bid and Payment

14.1 The unit rates and the prices shall be quoted by the bidder entirely in Indian Rupees.

15. Bid Validity

15.1 Bids shall remain valid for a period not less than **one hundred and twenty days** from the date of opening of Technical Bid. A bid valid for a shorter period shall be rejected by the Employer as non-responsive.

15.2 In exceptional circumstances, prior to expiry of the original time limit, the Employer may request the bidders to extend the period of validity for a specific additional period. The request and the bidders' response shall be made in writing or by cable. A bidder may refuse the request without forfeiting his bid security. A bidder agreeing to the request will not be required or permitted to modify his bid, but will be required to extend his bid security for; the period of extension.

16. Bid Security

16.1 The bidder shall furnish, as part of his bid, as bid security of **Rs. 1.50 lakh (Rupees One lakhs and fifty thousand only)** duly pledged in favour of the **Project Engineer, P.M Unit, OWSSB, Cuttack.** in any one of the following forms Demand draft / Deposit call receipt / Fixed deposit receipt / Bank guarantee issued by any Nationalised Bank / Scheduled Bank located in India, National savings certificate, Post office Savings Bank deposits.

- Unconditional Bank Guarantee in the prescribed format for the bid security issued by a Nationalised Bank/Scheduled Bank located in India & valid for 45 days after the end of the validity period of the bid.

FDR and deposits at call receipts should contain lien certificate issued by the Bank for encashment by department. The FDR furnished by the firm should also bear the signature of the authorized signatory on a revenue stamp at the back of the FDR.

16.2 Any bid not accompanied by bid security in stipulated form shall be rejected by the Employer as non-responsive.

16.3 The bid security of the unsuccessful bidders will be returned as promptly as possible, but not later than 30 days either after the expiration of the period of bid validity or after finalisation of the bid whichever is later.

16.4 The bid security of the successful bidder will be returned after the bidder has furnished the required performance security and signed the agreement. No interest is payable on Bid security by the Employer.

16.5 The bid security shall be forfeited.

- In the case of bidder withdrawing or modifying his bid during the period of bid validity
- If the bidder does not accept the corrections of the bid price, pursuant to clause 28 of "Bid Opening and Evaluation"
- In the case of a successful bidder failing to furnish the performance security in the specified form within the stipulated time.
- In the case of successful bidder failing to enter into agreement within the stipulated time.
- In the case of the bidder severing the conditions after intimation of the acceptance of the bid.

17. Compliance to Technical Design and Specifications.

17.1 Bidders shall submit their offers that comply with the requirements of the bidding documents including the basic technical design as indicated in the drawing and specifications.

18. Format and Signing of Bid

- 18.1 The bid document submitted to the Employer shall be typed or written in indelible ink and shall be signed by a person duly authorised to sign on behalf of the bidder in accordance with "Instructions to Bidders". All pages of the bid and where entries or corrections have been made shall be initialed by the person signing the bid.
- 18.2 The bid shall contain no alteration or additions, except those to comply with the instructions issued by the Employer and wherever necessary to correct errors made by the bidder, in which case such corrections shall be initialed by the person signing the bid.
- 18.3 The technical and price bids (BOQ) as issued by the Employer should be submitted duly signed at the bottom of each page, failing which the bids will be summarily rejected.

19. Pre Bid Meeting:

19.1

The bidder or his authorised representative, who are desirous, may attend the pre bid meeting which will take place at **The Member Secretary, OWSSB on at 11.00 AM.**

- 19.2 The purpose of the meeting will be to clarify issues and to answer questions on any matter than may be raised at that stage.
- 19.3 The bidder is requested, as far as possible, to submit the questions in writing or by cable, to reach the Employer not later than one week before the meeting. It may not be practicable at the meeting to answer questions received late.
- 19.4 Minutes of the meeting, including the text of the questions (without Identifying the source of enquiry) and the responses given together with any responses prepared after the meeting, will be transmitted without delay to all purchasers of the bidding documents. Any modification of the bidding documents listed in clause 23.1 of "Submission of Bids", which may become necessary as a result of the pre bid meeting shall be made by the Employer exclusively through the issue of an addendum pursuant to clause 10 of the "Bid Document" and not through the minutes of the pre bid meeting. Then will be hosted on www.odisha.gov.in
- 19.5 Attendance at the pre bid meeting is not mandatory and non-attendance will not be a cause for disqualification of the bidder.

E. SUBMISSION OF BIDS

20. Sealing and Marking of Bids

- 20.1 Two cover system shall be adopted for submission of bids.
- 20.2 The first cover shall contain the technical bid documents, supporting material relating to the eligibility criteria, Bid Security in the proper form and other connected Certificates.
- 20.3 No indication direct or indirect, implicit or explicit regarding the rates and prices should be made in the technical bid or any other documents submitted in the first cover.
- 20.4 The second cover shall contain the Price Bid alone.
- 20.5 The bids should be submitted in the original bid documents as issued by the Employer.
- 20.6 The bid documents, under no circumstances, are transferable.
- 20.7 The first cover containing the Technical Bid and Bid Security and the second cover containing the Price Bid, should be pasted properly, sealed and super scribed indicating clearly the name of work and marking specifically as under:

Cover I - Technical Bid

Cover II - Price Bid

Both the covers containing the Technical bid and Price Bid should be placed in a common envelope, pasted, sealed and superscribed properly.

20.8 Format and signing of Tender

- 20.8.1 The Bidder shall submit one original and one copy (Hard) and one soft copy of technical bids comprising of Tender as described in the Instruction to Bidders, bound in a format as stipulated.
- 20.8.2 All bidders will be provided with an electronic copy of the schedule of prices. Cells that contain permanent information and are not to be changed by the Bidder will be protected.
- 20.8.3 Cells into which the bidder can enter rates and Amount (where these may vary), will be left unprotected. However, the Employer will not enter any formulae in the spread sheets.
- 20.8.4 The Bidder is entirely responsible to ensure that the calculations presented in the Schedule of Prices are correct, and that the Bidders offer is complete in all respects. The Price Bid completed in computerized printout, adopting the format of the Bid document in total and shall be signed by a person or persons duly authorized to sign on behalf of the Bidder.

- 20.8.5 The Bidder will need to submit the completed Schedule of Prices together with the bound copy of the Price Proposal which has been issued by the Employer along with the separate Priced Schedule of Prices, and to affix his signature on all pages of his submittal. The Bidder shall give an undertaking that the content of the CD and the content of hard copies are identical. In the case of discrepancy between the soft copy and hard copy (print out) furnished by the bidder, the hard copy (print out) will prevail. If there is discrepancy between the hard/soft copy furnished by the bidder and the hard copy issued by the Employer, the hard copy issued by the Employer will prevail.
- 20.8.6 The Tender shall contain no alternations, omissions or additions, except those to comply with instructions issued by the Employer, or as necessary to correct errors made by the Bidder, in which case such corrections shall be initialed by the person or persons signing the Tender.
- 20.8.7 All the envelopes shall be addressed to the Employer **the Member Secretary, OWSSB**, and bear the following identification.

Bid for

Construction of Septage treatment Plant in Bhubaneswar City in Khordha District, Odisha - Construction of Settling-thickening tanks, Sludge drying beds, Anaerobic Baffled Reactors, Horizontal planted gravel filter, Maturation pond, Filtrate sump, Security room, CC pavement, construction of compound wall around the treatment plant, Effluent disposal arrangement, Construction of Pump Room of 12 m², supply, delivery and installation of Non clog submersible pump sets, laboratory room, watch shed, administrative room etc. complete including Trial run for 3 Months (period of completion - 9 months)

IFB NO. / SeTP/2016.

Do Not Open Before **at 4.00 PM** (Time and date of bid opening as per Clause 24 of "Bid Opening and Evaluation") and should be submitted to the following address.

**The Member Secretary,
OWSSB, SATYA NAGAR,
Bhubaneswar – 751 007.**

- 20.9 In addition to the Identification required in sub clause above, the envelope shall indicate the name and address of the bidder to enable the bid to be returned in case it is declared late, pursuant to Clause 22 of "Submission of Bids".
- 20.10 If the envelope is not sealed and marked as above, the Employer will assume no responsibility for the misplacement or premature opening of the bid.

21. Deadline for Submission of the Bids

- 21.1 Bids must be received by the Employer at the address specified in clause 20.8 above not later than **P.M. on** In the event of the specified date for the submission of bids declared a holiday for the Employer, the bids will be received up to the appointed time on the next working day.

- 21.2 The Employer may extend the deadline for the submission of bids by issuing amendment in accordance with clause-10 of "Bid Document" in which case all rights and obligations of the Employer and the bidders previously subject to the original deadline will then be subject to the new deadline.

22. Late Bids

- 22.1 All bids received by the Employer after the deadline prescribed in clause 21 of "Submission of Bid" will be returned unopened to the bidder.

23. Modification, Substitution and Withdrawal of Bids

- 23.1 The bidder may modify, substitute or withdraw his bid after submission, provided that written notice of the modification, substitution and withdrawal is received by the Employer prior to the deadline for submission of bid.
- 23.2** The bidder's modification, substitution or withdrawal notice shall be prepared, sealed, marked and delivered in accordance with provisions of clause 20 and 21 of "Submission of Bid", with the envelope additionally marked '**MODIFICATION**', '**SUBSTITUTION**' or '**WITHDRAWAL**' as appropriate. The modification / substitution for price bid cover should be super scribed as **PRICE 'MODIFICATION' / SUBSTITUTION COVER**.
- 23.3 No bid shall be modified, substituted or withdrawn after the deadline for submission of bids.
- 23.4 Modification, substitution or withdrawal of a bid between the deadline for submission of bids and the expiration of the original period of validity specified in clause 15.1 of "Preparation of Bids" or as amended pursuant to clause 15.2 of "Preparation of Bids" may result in the forfeiture of the Bid Security pursuant to Clause 16 of "Preparation of Bids".

F. BID OPENING AND EVALUATION

24. Bid Opening

- 24.1 The Employer will open all the bids received (except those received late) including modifications made pursuant to clause 23 of "Submission of Bids", in the presence of the bidders or their representatives who choose to attend on the date at the time in the address specified in clause 20 of "Submission of Bids".(In the event of specified date of bid opening being declared a holiday for the Employer, the bids will be opened at the appointed time and location on the next working day).
- 24.2 Envelopes marked "withdrawal", "substitution" and "modification" shall be opened and read out first. Bids for which an acceptable notice of withdrawal has been submitted pursuant to clause 23 of "Submission of Bids" shall not be opened. Envelopes superscribed as '**MODIFICATION**' / **SUBSTITUTION to price bid will be opened at the time of opening of the price bid.**
- 24.3 The Bidders' names, the Bid prices, the total amount of each Bid, any discounts, bid modification, (substitution) and withdrawals, the presence or absence of Bid Security and such other details as the Employer may consider appropriate, will be announced by the Employer at the opening. Bids (and modifications) sent pursuant to clause 22 of "Submission of Bids" that are not opened and read out at the bid opening will not be considered for further evaluation regardless of the circumstances. Withdrawn bids will be returned unopened to the bidders.

25. Process to be Confidential

- 25.1 Information relating to the examination, clarification, evaluation and comparison of bids and recommendations for the award of a contract shall not be disclosed to bidders or any other person not officially concerned with such process until the award to the successful Bidder has been announced. Any effort by a bidder to influence the Employer's processing of Bids or award decisions may result in the rejection of his bid.

26. Clarification of Bids.

- 26.1 To assist in the examination, evaluation and comparison of bids, the Employer may, at his discretion, ask any Bidder for clarification of his bid, including breakdown of unit rates. The request for clarification and the response shall be in writing or by cable, but no change in the price or substance of the Bid shall be sought, offered, or permitted except as required to confirm the correction of arithmetic errors discovered by the Employer in the evaluation of the Bids in accordance with Clause 28 of "Bid Opening and Evaluation".

27. Examination of Bids and Determination of Responsiveness

- 27.1 Prior to detailed evaluation of Bids, the Employer will determine whether each Bid
- (a) meets the eligibility criteria set out in clause (7);
 - (b) has been properly signed,
 - (c) is accompanied by the required securities and
 - (d) is substantially responsive to the requirements of the Bid Documents,

27.2 A substantially responsive Bid is one which conforms to all the terms, conditions and specifications of the Bid Documents, without material deviation or reservation. A material deviation or reservation is one (a) which affects in any substantial way the scope, quality or performance of the works. (b) which limits in any substantial way, inconsistent with the Bid Documents, the Employer's rights to the Bidder's obligations under the contract, or (c) whose rectification would affect unfairly the competitive position of other bidders presenting substantially responsive Bids.

27.3 If a Bid is not substantially responsive, it will be rejected by the Employer, and may not subsequently be made responsive by correction or withdrawal of the non-conforming deviation or reservation. The decision of the Employer on the issue whether the Bid is responsive or not" will be final and binding on the bidders. The Employer is not bound to disclose the reason in case a bid is determined by him as non-responsive.

28. Correction of Errors

28.1 Bids determined to be substantially responsive will be checked by the Employer for any arithmetic error. Errors will be corrected by the Employer as follows:

- If any variation in the rates in words and figures, the lesser of the two will only be taken into consideration.
- Where there is a discrepancy between the unit rate and line item total resulting from multiplying the unit rate by the quantity, the unit rate as quoted will govern.
- Where there is an arithmetical discrepancy in the page total as well as grand total, the corrected total by the Employer will govern

28.2 The amount stated in the Bid will be adjusted by the Employer in accordance with the above procedure for the correction of errors and shall be considered as binding upon the Bidder. If the Bidder does not accept the corrected amount of the Bid, his bid will be rejected and his bid security may be forfeited in accordance with Clause 16.5 of "Preparation of Bids".

29. Evaluation and Comparison of Bids.

29.1 The Employer will evaluate and compare only the Bids determined to be substantially responsive in accordance with Clause 27 of "Bid Opening and Evaluation".

29.2 In evaluating the Bids, the Employer will determine for each Bid the evaluated Bid Price by adjusting the Bid price as follows:

- Making any correction for errors pursuant to Clause 28 of "Bid Opening and Evaluation". or
- making appropriate adjustments to reflect discounts or other price modifications offered in accordance with Clause 23 of "Submission of Bids"

29.3 The Employer reserves the right to accept or reject any variation/deviation.

29.4. If the Bid of a successful Bidder is seriously unbalanced in relation to the Engineer's estimate of the cost of work to be performed under the contract, the Employee may require the Bidder to produce detailed price analysis for any or all items of the Bill of Quantities to demonstrate the internal consistency of those prices with the construction methods and schedule proposed.

After evaluation of the price analysis, the Employer may require that the amount of the Performance Security set forth in Clause 34 of; "Award of Contract" be increased at the expense of the successful Bidder to a level sufficient to protect the Employer against financial loss in the event of default of the successful Bidder under the Contract.

For tenders received with 5 to 15% less than the departmental value the successful tender should remit additionally 2% towards security deposit on departmental value.

For tenders received with beyond 15% less than the departmental value, the successful Bidder should remit 50% of the difference between the departmental value and the value of tender as additional security deposit.

G. AWARD OF CONTRACT

30. Award Criteria.

30.1 Subject to Clause 29 of "Bid Opening and Evaluation", the Employer will award the contract to the Bidder, whose Bid has been determined to be substantially responsive to the Bid Documents and who has offered the lowest evaluated Bid Price, provided that such Bidder has been determined to be (a) eligible in accordance with the provision of clause 6 of "Eligibility/Qualification Criteria" and (b) qualified in accordance with the provisions of Clause 7 of "Eligibility / Qualification Criteria".

31. Employer's Right to Accept any Bid and to Reject any or all Bids

31.1 The Employer reserves the right to accept or reject any bid, and to annul the bidding process and reject all bids, at any time prior to award of contract, without thereby incurring any liability to the affected bidder or bidders or any obligation to inform the affected bidder or bidders of the grounds for the Employer's action.

32. Notification of Award

32.1 The Bidder whose Bid has been accepted will be notified of the award by the Employer prior to expiration of the Bid validity period by cable, telex or facsimile confirmed by registered letter. This letter (hereinafter and in the Conditions of Contract called the "Letter of Acceptance"), will state the sum that the Employer will pay to the contractor in consideration of the execution, completion and maintenance of the works by the Contractor as prescribed by the Contract (hereinafter and in the conditions of Contract called the "Contract Price")

32.2 The notification of award will constitute the formation of the Contract.

33. Registration in Govt. of Odisha

33.1 The successful contractor/firm, if not a registered contractor in Odisha Supply and Drainage Board, he / they shall get himself / themselves registered in

34. Performance Security

34.1 A) Within 28 days from the date of the Letter of Acceptance, the successful bidder shall deliver to the Employer a Performance Security

i) in the form of National Savings Certificate / Post Office Savings Deposit account purchased within the State of Odisha and pledged in favour of the **Project Engineer, PMU, OWSSB, Cuttack.**

(OR)

ii) Unconditional and irrevocable bank guarantee issued by any one of the branches of Nationalised Bank or scheduled Bank within the State of Odisha, provided they are in prescribed format (enclosed in this Document) for an amount equivalent to 5% of the total value of the contract in favour of the **Project Engineer, PMU, OWSSB, Cuttack.**

34.2 The bidder along with the performance security shall deliver a non-judicial stamp paper for Rs.100/- (Rupees hundred only) at his cost for executing the agreement.

35. Signing of Agreement

35.1 The Employer on receipt of the performance security and non-judicial stamp paper, will furnish to the bidder the Agreement in the form prescribed, incorporating all terms and conditions between the Employer and the successful bidder.

35.2 The Bidder should remit the performance security prescribed by the Employer in the form as in Clause 34 above and sign the agreement in the presence of the Employer within 28 days from the date of Letter of Acceptance notifying the award of contract.

35.3 Upon furnishing the performance security by the successful bidder, the Employer will promptly notify the other bidders that their bids have been unsuccessful.

35.4 Failure of the successful bidder to comply with the requirements of Clause 34 & 35 and 35.2 of "Award of Contract" shall constitute a breach of contract, cause for annulment of the award, forfeiture of the bid security and any such other remedy the Employer may take under the contract

Amendment to Agreement

35.5 Any amendment shall be issued by mutual consent between the Employer and the contractor only without any contrary to the bid conditions.

36. Mobilisation Advance

Mobilisation advance not allowed.

37. Forfeiture of Performance Security

37.1 The performance security is liable to be forfeited in cases where the firm/contractor fails to carry out the work in accordance with the specifications, terms and conditions of the contract leading to termination of the contract.

IV- PROGRAMME SCHEDULE

38. Project completion and Financial Milestone

- 38.1 The twenty eighth day from the date of issue of work order shall be reckoned as the start date of the contract period.
- 38.2 Entire project must be completed in all respects within **Nine months** for construction work and Three months for trial run, successful commissioning & proof of guarantee performance.
- 38.3 The milestone for each component would be as under:

| Sl. No. | Description | % of achievement | Cumulative % of achievement |
|---------|--|------------------|-----------------------------|
| 1. | Up to I Quarter (3 Months) | 40 % | 40 % |
| 2. | Up to II Quarter (6 months) | 30 % | 70 % |
| 3. | Up to III Quarter (9 months) | 30 % | 100% |
| 4. | After completion of work – 3 Months | | Trial run |

39. Programme Schedule / Rate of Progress / Milestone

39.1 The Contractor, within seven days from the date of signing of the agreement shall submit to the Engineer for approval **an Activity Chart showing the general methods, arrangements, order and timing for all the activities in the Works.**

39.2 An update of the Activity Chart shall be a Programme showing the actual physical progress achieved on each activity and the progress to be achieved on the remaining work including any changes to the sequence of activities. The Contractor shall submit to the Engineer in charge, for approval, an updated Activity Chart. The Employer reserves the right to approve or reject the updated Activity Chart without prejudice to levying of liquidated damages for slow progress.

40. Penalty for Defective Construction

If any defect is noticed by the Employer in the construction of any portion of work/component, the Employer shall levy penalty up to 10% of the total value of the defective work as assessed by the Engineer in charge, in addition to rectification of defective works at his cost.

41. Liquidated damages

41.1 Provided the firm/contractor fails to maintain the required rate of progress/mile stones liquidated damages will be invoked at the rate of 0.05% per week for the unfinished work. The firm/ contractor achieve the next mile stone within the stipulated period cumulatively

(i.e. including the first mile stone) the levied Liquidated Damages will be revoked. The amount recoverable towards liquidated damages shall however be restricted to 10% of the total contract value. The imposition of the liquidated damages clause will be without prejudice to the rights of the Employer to terminate the contract as time barred.

41.2 For imposing liquidated damages, detailed show cause notice shall be served on the defaulting firm/contractor either by RPAD or through personal service. The first notice shall be served allowing 15 days' time to the firm/contractor for furnishing the reply by them. In case of non-receipt of reply on expiry of 15 days' time from the date of first notice, the second notice shall be served allowing 7 days of time to the firm/contractor for furnishing the reply by them. Again in case of non-receipt of reply on expiry of 7 days' time from the date of second notice, the third notice shall be served allowing 3 days of time to the firm/contractor for furnishing the reply by them. On receipt of the reply, it shall be verified by the Engineer in charge and liquidated damages clause shall be invoked by issuing an explicit speaking order to the firm/ contractor, Similarly, the non-receipt of any reply from the firm/ contractor shall attract imposing the liquidated damages clause automatically and in this case also, the liquidated damages shall be imposed by issuing an explicit speaking order to the firm/contractor.

42. Foreclosure of Works

The Employer shall have the right to issue notice to the firm/contractor, for any reason whatsoever does not require the whole or part of the works to be carried out after the award of the contract. The contractor shall not have any claim towards compensation or whatsoever, on account of any profit or advantage, which he might have derived from the execution of such works. For the works executed which could not be utilised in view of the foreclosure, the firm/contractor shall be paid a eligible amount as certified by the Engineer in charge.

V- PAYMENTS AND RECOVERIES

43. Payment Schedule

Payment shall be made in stages for each component as envisaged under:

CIVIL WORKS:

95% of the measured and check measured quantity

2.50% on commissioning of the scheme

2.50% on completion of the Trial run period

PUMPING MAIN, BOOSTER MAIN FEEDER MAIN, GRAVITY MAIN AND D'SYSTEM

1. For Pipes & allied works

| | |
|---|--------|
| After supply at site | - 75% |
| After laying, jointing and testing of pipe | - 85% |
| After satisfactory completion of trial run & after commissioning of the entire length of main | - 95% |
| After completion of full Trial run period of the scheme as a whole | - 100% |

2. Mechanical items in pumping & treatment plant

| | |
|--------------------------------------|--------|
| After receipt of materials at site | - 75% |
| After erection | - 90% |
| After commissioning | - 95% |
| After completion of Trial run period | - 100% |

Trial run Period:

Trial run of the scheme – **3 months at Free of Cost.**

Note:

- The percentage of payment mentioned above are with reference to the total value of each component as per the agreement entered into by the firm/contractor except pumping main and distribution system.
- The payment shall be made for each component as per the actual measurement up to the percentages mentioned above for the stage of progress of each component. In the case of actual value of works carried out becoming lesser than the percentage limits prescribed for the stages, the payments shall be restricted to the actuals.
- 5% of the value of every running bill shall be retained by the Employer as additional performance security.
- Payments shall become eligible only for finished items of works in all respects.

43.1 Preparation of bills:

The Contractors will submit their bills every month in the M. Book format for the Quantity only of the relevant running bill duly signed. This will be treated as claim of the Contractor to consider payment every month.

The Contractor shall submit their bills to the Executive Engineer or any of his subordinate officer under his control as directed by the Executive Engineer. The Executive Engineer shall be responsible to scrutinize and make payment to the Contractor within 6 weeks from the date of submission of bills by the Contractor concerned.

44. Release of Performance Security & Retention Amount

- 44.1 In addition to the withheld amount, 40% of the amount of each bill of the contract shall be deducted and will be retained till the date of receipt of certificate of water tightness from the **Project Engineer, PMU, OWSSB, Cuttack**. The whole of the above sum of together with any recovery from the payments already made to the contractor as may be assessed by Project Engineer, PMU, OWSSB, Cuttack shall be forfeited to the OWSSB if the RCC reservoir develops structural defects or leaks. The above recovery shall be exclusive of the amount deposited towards security deposit. The fact of carrying out water tightness test should be recorded in the M. Book. The last part bill should be passed only after above certificate is issued. However, the contractor shall be permitted to execute an indemnity bond/BG in lieu of the recovery of 40% in each bill in prescribed form in non-judicial stamp paper for a value of Rs.100.00 towards water tightness and structural stability of the reservoir/water retaining structure. The period of guarantee required by the contract shall be two years from the date of completion

and commissioning (with filling of water up to maximum water level in the case of service reservoir/overhead tanks/water retaining structure). If defects are noticed within the stipulated period of **24 months** of satisfactory performance, the defects should be rectified by the contractor at his own cost and the performance period again shall be reckoned from the date of completion of the rectification of defects by the contractor. In the case of service reservoir/overhead tanks and other water retaining structures during this period, structure under full working head of water should show no sign of leakage. The test for water tightness should be arranged to be carried out and completed within 30 days from the date of intimation by the Engineer in charge. The testing of the service reservoir/overhead tank and other water retaining structures should be done by the contractor at his own cost inclusive of all necessary equipment, water etc., complete. The test for water tightness of the structure as well as materials of construction used shall be conducted in conformity with the standard specifications as per I.S. 3370 (Part-I) – 2009 as amended from time to time and the other specifications as mentioned in the Bid Document.

- 44.2 The security deposit less any amount due to the Board and 2 ½ % out of the total 5% of the retention amount made in every running bill shall be released in final bill which shall be prepared after the works are completed in all respects and after completion of Trial run period.
- 44.3 In respect of building works, RCC reservoir and other works where water tightness and soundness are to be observed for more than six months notwithstanding above clause, the balance 2 ½ % out of the total 5% retention amount from final bill in respect of contract for original construction or original building works, construction of RCC reservoir etc., will be retained by Engineer-in-Charge and paid to the contractor after a period of 24 months of satisfactory performance of entire civil works including trial period and on production of irrevocable Bank Guarantee in a prescribed form for the above amount to ensure structural stability.

45. Recovery of money payable to OWSSB

- 45.1 All losses, costs, damages and expenses and other money payable to the Board by the contractor under any stipulation in the contract, may be retained out of any money due or which may subsequently become due from the Board to the contractor under any contract or otherwise whatsoever and in case such money then due or to become due to the contractor by the Board shall be insufficient to pay such losses, costs, damages, and other money payable to the Board by the contractor, it shall be lawful for the Engineer in charge without any further consent on the part of the contractor to sell notes for the securities deposited in the Board by the contractor as aforesaid and with and out of the proceeds of such sale, after payment of all expenses connected therewith or reimburse and pay to the Board all such losses, cost, damages and expenses and other money payable to the contractor. And in case such proceeds of sale of the said securities shall be insufficient for such purpose

then and in that case it shall be lawful for the Board to recover the residue thereof, if necessary by legal proceedings and or by resorting to revenue recovery act against the contractor.

46. Income Tax

46.1 During the course of the contract period, deduction of income tax shall be made at the prevailing rates from every payment as may be specified by the Income Tax Department and as amended time to time.

47. Sales Tax

47.1. From every payment made to the firm/ contractor, deduction at source towards tax shall be made for civil works contract (presently at 2%) and for all other works contract (presently at 5%) subject to issue of amendments from time to time by Odisha Commercial Tax Department.

48. Excise Duty & Service Tax.

48. a. Excise Duty.

All rates are inclusive of Excise Duty.

Excise duty is applicable in Water Supply Schemes wherever necessary as prescribed in Notification No. 12/2012 – Central Excise, Dated: 17.03.2012. Subject to the issue of amendments from time to time by GOI, Ministry of Finance, Department of Revenue, New Delhi.

b. Service Tax.

Service taxes applicable wherever necessary as per Notification No: 25/ 2012 – Service tax, dated: 20.06.2012 subject to issue of amendments from time to time by GOI, Ministry of Finance, Department of Revenue, New Delhi.

49. BUILDING AND CONSTRUCTION WORKERS WELFARE CESS

Towards contribution of fund for the benefit of manual workers employed in the construction works an amount equivalent to one percent of total estimated cost of the construction work proposed will be paid by the Employer direct to the respective welfare Board, subject to issue of amendments from time to time by the respective department of Government of Odisha.

(Lump sum provision for this contribution may be appropriately made in the Estimates sanctioned for the schemes and the amount would be remitted at the end of the financial year to the labour welfare Board)

50. Price Adjustment:-

50.1 The conditions for price adjustment shall be as follows.

Price Variation / Escalation Clause: (Vide Works Deptt. Office Memorandum No.12606/W dt.24.12.2012)

Contract price shall be adjusted for increase or decrease in rates and price of Labour, Cement, Steel, Bitumen, Pipes, POL & other material component in accordance with the following principles and procedures as per formula given below:-

i) - REIMBURSEMENT / RECOVERY DUE TO VARIATION IN PRICES OF MATERIALS OTHER THAN (STEEL, CEMENT, BITUMEN, PIPES & P.O.L.)

If during the progress of the work, the price of any material (excluding the cost of Steel, Cement, Bitumen & P.O.L) incorporated in the work (not being materials supplied from the Engineer-in-charge's store) in accordance with Clause thereof increases or decreases as a result of increase or decrease in the average wholesale price index (all commodities), and the contractor thereupon necessarily and properly pays in respect of that material (incorporated in the work) such increased or decreased price, then he shall be entitled to reimbursement or liable to refund, quarterly as the case may be, such an amount as shall be equivalent to the plus or minus difference of 85% in between the average wholesale price index (all commodities) which is operating for the quarter under consideration and that operated for the quarter in which the bid was received (last date of receipt) as per the formula indicated below provided that the work has been carried out within the stipulated time or extension thereof as are not attributable to him. If penalty is levied for delayed completion of the work, the contractor shall not be eligible to get price escalation on the above materials on the value of works executed during the extended period.

The clause will be applicable to the contracts where original stipulated period of completion is more than 18 months.

In the situation where the period of completion is initially stipulated in the agreement as less than 18 (eighteen) months but subsequently the completion period has been validly extended on the ground that the delay in completion is not attributable to the contractor and in the result the total period including the extended period stands more than 18(eighteen) months or more, price escalation for other materials is admissible only for the remaining period excluding 18(eighteen) months there from.

Formula to calculate the increase or decrease in the price of materials:

Price adjustment for increase or decrease in cost of materials other than cement, steel, bitumen, pipes and POL procured by the contractor shall be paid in accordance with the following formula.

$$V_m = 0.85 \times P_m = 100 \times R \times (M_i - M_0) / M_0$$

V_m = Increase or decrease in the cost of work during the quarter under consideration due to changes to rates of materials other than cement, steel, bitumen, pipes and POL.

R= Value of work done during the quarter under consideration excluding the work executed under extra items if any at prevailing schedule of rate / derived rates.

M_0 = The all India wholesale price index (all commodities) prevailed during the quarter of last date of receipt of bids (as published by the Economic Adviser to Govt. of India, Ministry of Industry and commerce, New Delhi)

M_i = The all India wholesale price index (all commodities) for the quarter under consideration as published by Economic Advisor, govt. of India, Ministry of Industry and commerce, New Delhi. In respect of the justified period extended for completion of the work, the index prevailing at the time of stipulated date of completion or the prevailing index of the period under consideration, whichever is less, shall be considered.

P_m = Percentage of material component (other than cement, steel, bitumen, pipes and POL) of the work, as indicated in clause – 3.19(d) below.

ii) REIMBURSEMENT / RECOVERY OF DIFFERENTIAL COST DUE TO VARIATION IN PRICES OF PRINCIPAL MATERIALS (STEEL, CEMENT, BITUMEN AND PIPES NOT ISSUED BY DEPARTMENT) AFTER SUBMISSION OF TENDER.

If after submission of the tender, the prices of Steel , Cement, Bitumen and Pipes (not being supplied by the Department) increases / decreases beyond the price (s) prevailing at the time of the last date for submission of tenders including extension for the work, the contractor shall be eligible to get differential cost due to such hike on the value of works execute during the stipulated period and during the extended period when the reason of delay in completion of the work is not attributable to the contractor, If penalty is levied for delayed completion of the work, the contractor shall not be eligible to get price variation on the above materials on the value of works executed during the extended period.

Reimbursement in case of differential cost due to increase in prices of cement, steel, bitumen and pipes are to be made by the Project Engineer with prior approval of tender accepting authority subject to following conditions;

- 1) Contractors have to submit the vouchers showing procurement of different materials from authorized dealers for the said work.
- 2) Differential cost will be allowed only for the works which are progressed as per the approved work programme / revised work programme duly approved by the Engineer in charge.

Recovery in case of decrease in prices of cement, steel, bitumen and pipes shall be made by concerned Project Engineer for the contractor immediately.

The increase/decrease in prices of cement, steel, Bitumen and Pipes for reimbursement / recovery shall be determined as follow.

a) Adjustment towards differential cost of cement.

$V_c = (C_i - C_0)/C_0 \times$ Actual quantity of cement utilize in the work during the quarter under consideration \times base price of cement as prevailing on the last stipulated date of receipt of tender including extension, if any.

V_c = Differential cost of cement i.e. amount of increase or decrease in rupees to be paid or recovered.

C_i = All India Wholesale price index for cement for the quarter under consideration as published by Economic Adviser, Govt. of India, Ministry of Industry and commerce, New Delhi.

C_0 = All India Wholesale price index (as published by Economic Adviser, Govt. of India, Ministry of Industry and commerce, New Delhi) for cement as prevailing on the last stipulated date of receipt of tender.

b) Adjustment towards differential cost of Steel

$V_s = (S_i - S_0) \times$ Actual quantity of steel utilized in the work during the quarter under consideration.

V_s = Differential cost of Steel i.e. amount of increase or decrease in rupees to be paid or recovered.

S_i = cost of the Steel as prevailed during the period under consideration as fixed by Steel authority of India.

S_0 = Base price of Steel prevailing as on the last date of submission of tender including extension, if any.

c) Adjustment towards differential cost of Bitumen.

$V_b = (B_i - B_0) \times$ Actual quantity of Bitumen utilized in the work during the quarter under consideration.

V_b = Different cost of Bitumen i.e. amount of increase decrease in rupees to be paid or recovered.

B_i = Average cost of Bitumen prevailed during the period under consideration as fixed by IOCL/BPCL/HPCL.

B_0 = Base price of bitumen as prevailing on the last stipulated date of receipt of tender including extension, if any.

d) Adjustment towards differential cost of pipes.

$$V = 0.85P_p / 100 \times R(P_i - P_0)/P_0$$

V_p = Differential cost of pipe i.e. amount of increase or decrease in rupees to be paid or recovered during the quarter under consideration.

P_p = Percentage of pipe component of the work as indicated in the clause 3.19(d) .

R = Value of work done during the quarter under consideration excluding the value of work executed under extra items, if any, at prevailing schedule of rates or derived rate.

P_i = All India Wholesale price index for the period under consideration as published by Economic Advisor, Govt. of India, Ministry of Industry and Commerce, New Delhi, for the type of pipe under consideration.

P_0 = All India Wholesale Price Index (as published by Economic Advisor, Govt. of India, Ministry of Industry and Commerce, New Delhi) as on the last stipulated date of receipt of tender including extension, if any, for the type of pipe under consideration.

50.2 REIMBURSEMENT / REFUND DUE TO STATUTORY RISE IN COST OF MINIMUM WAGES BY GOVERNMENT.

If after submission of the tender, the wages of labour increases or decreases as a direct result of the coming into force of any fresh law, or statutory rule or order beyond the wages prevailing at the time of the last date of submission of tenders including extensions, the contractor shall be eligible to get escalation due to such hike on the value of works executed during the stipulated period and during the validly extended period when the delay in completion is not attributable to the Contractor. If penalty is levied for delayed completion of the work, the contractor shall not be eligible to get escalation on labour on the value of works executed during the extended period.

The contractor shall within a reasonable time of his becoming aware of any alteration in the price of any such wages of labour, give notice thereof to the Engineer-in-charge stating that the same is given pursuant to this condition together with all information relating thereto which he may be in a position to supply. Engineer-in-Charge may call books of account and other relevant documents from the contractor to satisfy himself about reasonability of increase in prices of

wages and actual payment thereof For this purpose, the labour component of the work execute during period under consideration shall be the percentage (as specified in table below) of the value of work done during that period and the increase / decrease in labour shall be considered on the cost of minimum daily wages of any unskilled labourers, fixed by the Government of Odisha under minimum wages act.

The compensation for escalation for labour shall be work out as per the formula given below.

$$V_i = 0.85 \times P_i / 100 \times R \times (L_i - L_0) / L_0$$

V_i = Increase or decrease in the cost of work during the quarter under consideration due to changes in rates of maximum wages.

R = Value of the work done during the quarter under consideration excluding the work executed under extra items if any at prevailing schedule of rate / derived rates.

L_0 = The minimum wages for labour as notified by State Govt. as prevailing on the last stipulated date of receipt of tender including extension, if any.

L_i = The minimum wages for labour as notified by State Govt. & as prevailed on the last date of quarter previous to the one under consideration in respect of the justified period extended, the minimum wages prevailing on the last date of quarter previous to the quarter pertaining to stipulated date of completion or the minimum wage prevailing on the last date of the quarter previous to the one under consideration, whichever is less, shall be considered.)

P_i = Percentage of labour component of the work, as indicated in the clause **3.19(d)**

REIMBURSEMENT/REFUND DUE TO VARIATION IN PRICES OF P.O.L.

Similarly, if during the progress of work the prices of Diesel, Petrol, Oil and lubricants increases or decreases as a result of the price fixed thereof by the Government of India and the Contractor thereupon necessarily and properly pays such increased or decreased price towards Diesel, Petrol, Oil and Lubricants used in th execution of the work, then he shall be entitled to reimbursement or liable to refund, quarterly, as the case may be such an amount as shall be equivalent to the plus or minus difference of 85% in between the price of POL. Which is operating for the quarter under consideration and that operated for the quarter of last date of receipt of bids as per the formula indicated below provided

that the work has been carried out within the stipulated time or extension thereof as are not attributable to him. If penalty is levied for delayed completion of work the contractor shall not be eligible to get price escalation on POL on the value of works executed during the extended period.

Formula to calculate the increase or decrease in the price of POL.

$$V_i = 0.85 \times P_i / 100 \times R \times (F_i - F_0) / F_0$$

V_i = Increase or decrease in the cost of work during the quarter under consideration due to Changes in rates for POL.

P_i = Percentage of POL component of the work as indicated in clause – 19d below.

R = Value of work done during the quarter under consideration excluding the work executed under extra items if any at prevailing schedule of rate / derived rates.

F_i = All India Wholesale price index for Fuel, Oil & Lubricant (High Speed Diesel) for the quarter under consideration as published by Economic Adviser, govt. of India, Ministry of Industry and Commerce, New Delhi. In respect of the justified period extended, the rates prevailing at the time of stipulated date of completion or the prevailing rates of the period under consideration, whichever is less, shall be considered F_0 = All India whole sale price index for fuel, oil and lubricant (High speed Diesel) as prevailing on the last stipulated date of receipt of tender including extension, if any.

The following percentages will give the price adjustment for the entire contract for different types of works as applicable given in the following table.

Percentage Table

| Sl. No. | Category of works | | % Component (cost wise) | | |
|---------|-----------------------------------|--------------------------------|--------------------------|-------------------------|--|
| | | | Labour (P _l) | P.O.L (P _f) | Steel + Cement+ Bitumen+ other materials * |
| 1. | R&B works (% of component) | Road works | 5 | 5 | 90 |
| | | Bridge works | 25 | 5 | 70 |
| | | Building works | 25 | - | 75 |
| 2. | Irrigation works (% of component) | Structural work | 20 | 5 | 75 |
| | | Earth, Canal & Embankment work | 25 | 10 | 65 |
| 3. | P.H. Work | Structural work | 25 | 5 | 70 |
| | | Pipeline work | 5 | - | <u>Pipe – 70%</u> * other material -25% |
| | | Sewer line | 10 | - | <u>Pipe – 70%</u> * other material -20% |

*Note: - Further break up may be worked out considering the consumption of cement, steel, Bitumen and pipe in the concerned works for the period under consideration.

APPLICATION OF ESCALATION CLAUSE:

(i) The contractor shall for the purpose of availing reimbursement / refund of differential cost of steel, bitumen, cement , pipe ,POL and wages, keep such books of account and other documents as are necessary to show that the amount of increase claimed or reduction available and shall allow inspection of the same by a duly authorized representative of Government and further, shall at the request of the Engineer-in-charge, furnish documents to be verified in such a manner as the Engineer-in-charge may require any document and information kept. The contractor shall within a reasonable time of 15 days of his becoming aware of any alteration in the price of such material, wages of labour and or price of POL give notice thereof to the Engineer-in-charge stating that the same is given pursuant to this condition along with information relating thereto which he may be in a position to supply.

ii) The compensation for escalation shall be worked out at quarterly intervals and shall be with respect to the cost of work done as per bills paid during the three calendar months of the said quarter. The first such payment shall be made at the end of three months after the month (excluding the month in which tender was accepted) and thereafter at three months' interval. At the time of completion of the work, the last period for payment might become less than 3 months, depending on the actual date of completion.

If at any time after the commencement of the work the Governor of Odisha shall for any reason whatsoever not require the whole thereof as specified in the tender to be carried out the Engineer-in-charge shall give notice in writing of the fact to the contractor who shall have no claim to any payment or compensation whatsoever on account of any profit or advantage, which he might have derived from execution of the work in full but which he did not derive in consequence of the full amount of the work not having been carried out, neither shall he have any claim for compensation by reason of any alterations having been made in the original specification, drawings, designs and instruction which shall involve any curtailment or increase of the work as originally contemplated.

VI- LIST OF ANNEXURES

| No. | Description | Para No. |
|------|---|-------------------------------|
| I | Performance of the Bidder showing value of Civil Engineering work for the past Five financial years | 7.1.4 |
| II | Average Annual Construction Turnover | 7.1.5 |
| III | Experience in works of similar nature and Magnitude within a period of Five years | 7.1.6 |
| IV | Commitment of works on hand | 7.1.6 |
| V | Works for which Bid already submitted | 7.1.6 |
| VI | List of Equipment available with Bidder | 7.1.7 |
| VII | Qualification/Experience of key personnel proposed for technical and administrative functions under this contract | 7.1.8 |
| VIII | Sample Format for evidence of access to or availability of credit facilities | 7.1.9 |
| IX | Details of Litigation | 7.1.10 |
| X | Declaration by the bidder | 7.1.11 |
| XI | Details of components proposed to be sublet and Sub-contractors involved | 7.1.12 |
| XII | Technical staff to be employed | Para 10 of General Conditions |

VI- LIST OF CERTIFICATES

| Sl. No. | Description of Certificate | Para No. |
|----------------|---|--------------------------|
| 1 | Signature of the proprietor or proprietress attested by the Notary Public | 2.2 |
| 2 | Signature of all the partners/power of attorney attested by the Notary Public | 2.3 |
| 3 | Registration of the firm, signature of the authorised person attested by the Notary Public | 2.4 |
| 4 | A copy of the registered power of attorney authorising the signatory of the bidder | 7.1.2 |
| 5 | Proof of registration of firm/Company | 7.1.3 |
| 6 | Audited Balance Sheets | 7.1.5 |
| 7 | Credit line Certificate from Financial institutions | 7.1.9 (Annexure-VIII) |
| 8 | Income Tax Clearance Certificate | 7.1.13 |
| 9 | Sales Tax Verification Certificate | 7.1.14 |
| 10 | Certificate of performance issued by not less than rank of Executive Engineer / Responsible person of the private organization. | |

ANNEXURE I**PERFORMANCE OF THE BIDDER SHOWING TOTAL MONETARY VALUE OF CIVIL ENGINEERING WORKS IN THE LAST FIVE FINANCIAL YEARS**

| Year | Monetary Value of Civil Engineering work (Rs. In lakhs) |
|-------------|--|
| 2010 - 11 | |
| 2011 -12 | |
| 2012 – 13. | |
| 2013 – 14. | |
| 2014 – 15. | |

Seal of the Firm**Signature of the bidder with date**

ANNEXURE II
ANNUAL CONSTRUCTION TURNOVER

Each Bidder must fill in this form

| Annual Turnover Data (Civil Engineering Works) in the last five Financial Years. | | |
|---|-------------|----------------------------|
| Sl. No. | Year | Amount Currency |
| 1 | 2010 - 11 | |
| 2 | 2011 -12 | |
| 3 | 2012 – 13. | |
| 4 | 2013 – 14. | |
| 5 | 2014 – 15. | |
| Average Annual Construction Turnover | | |

The information supplied should be the Annual Turnover of the Bidder in terms of the amounts billed to clients for each year for work in progress or completed.

Seal

.....
.....

(Signature of the Bidder)

ANNEXURE III

**EXPERIENCE IN WORKS OF SIMILAR NATURE AND MAGNITUDE WITH
IN A PERIOD OF 5 YEARS. (2011-12 to 2015-16)**

| Sl. No | Contract No. and Name of the Project | Description of the work | Name of the employer with full address | Value of the contract (Rs. In lakhs) | Date of Issue of work order and stipulated period of completion | Actual date of completion | Reason for the delay if any in completing the project |
|--------|--------------------------------------|-------------------------|--|--------------------------------------|---|---------------------------|---|
| | | | | | | | |
| | | | | | | | |
| | | | | | | | |
| | | | | | | | |
| | | | | | | | |
| | | | | | | | |
| | | | | | | | |
| | | | | | | | |
| | | | | | | | |
| | | | | | | | |
| | | | | | | | |
| | | | | | | | |
| | | | | | | | |
| | | | | | | | |
| | | | | | | | |
| | | | | | | | |

Seal of the firm

Signature of the bidder with date

ANNEXURE IV**COMMITMENTS OF WORKS ON HAND**

| Sl. No | Contract No and Name of the Project | Description of the work | Name of the employer with full address | Value of the contract (Rs. In lakhs) | Date of Issue of work order and stipulated period of completion | Value of works remaining to be completed (Rs. In lakhs) | Anticipated date of completion |
|---------------|--|--------------------------------|---|---|--|--|---------------------------------------|
| | | | | | | | |
| | | | | | | | |
| | | | | | | | |
| | | | | | | | |
| | | | | | | | |
| | | | | | | | |
| | | | | | | | |
| | | | | | | | |
| | | | | | | | |
| | | | | | | | |
| | | | | | | | |
| | | | | | | | |
| | | | | | | | |
| | | | | | | | |
| | | | | | | | |
| | | | | | | | |
| | | | | | | | |
| | | | | | | | |
| | | | | | | | |
| | | | | | | | |
| | | | | | | | |

Seal of the firm

Signature of the bidder with date

ANNEXURE V**WORKS FOR WHICH BID ARE ALREADY SUBMITTED**

| Sl. No | Contract No and Name of the Project | Description of the work | Name of the employer with full address | Value of the contract (Rs. In lakhs) | Stipulated period of completion | Date when decision is expected | Remarks if any |
|--------|-------------------------------------|-------------------------|--|--------------------------------------|---------------------------------|--------------------------------|----------------|
| | | | | | | | |
| | | | | | | | |
| | | | | | | | |
| | | | | | | | |
| | | | | | | | |
| | | | | | | | |
| | | | | | | | |
| | | | | | | | |
| | | | | | | | |
| | | | | | | | |
| | | | | | | | |
| | | | | | | | |
| | | | | | | | |
| | | | | | | | |
| | | | | | | | |
| | | | | | | | |
| | | | | | | | |
| | | | | | | | |

Seal of the firm

Signature of the bidder with date

ANNEXURE VI**LIST OF EQUIPMENT AVAILABLE WITH BIDDER**

| Sl. No | Equipment Name | Requirement for the project | | Availability Status | | | Remarks |
|-----------|-------------------|--------------------------------|----------|--|----------------------------|--------------------|---------|
| | | Nos | Capacity | owned/ leased/ To be procur ed | Nos and capa city | Age/ condit ion | |
| | | | | | | | |
| | | | | | | | |
| | | | | | | | |
| | | | | | | | |
| | | | | | | | |
| | | | | | | | |
| | | | | | | | |
| | | | | | | | |
| | | | | | | | |
| | | | | | | | |
| | | | | | | | |

Seal of the firm

Signature of the bidder with date

ANNEXURE VII**QUALIFICATION/EXPERIENCE OF KEY PERSONNEL PROPOSED FOR TECHNICAL
AND ADMINISTRATIVE FUNCTIONS UNDER THIS CONTRACT**

| Sl. No | Name of the person | Position for which proposed | Qualifi cation | Total Years of experience | Years of experience in the proposed position | Remarks |
|-------------------|-------------------------------|--|---------------------------|--|---|----------------|
| | | | | | | |
| | | | | | | |
| | | | | | | |
| | | | | | | |
| | | | | | | |
| | | | | | | |
| | | | | | | |
| | | | | | | |
| | | | | | | |
| | | | | | | |

Seal of the firm

Signature of the bidder with date

ANNEXURE VIII

**SAMPLE FORMAT FOR EVIDENCE OF ACCESS TO OR AVAILABILITY OF CREDIT FACILITIES
– CLAUSE 7.1.9**

BANK CERTIFICATE

This is to certify that M/s..... is a reputed company with a good financial standing.

If the contract for the work, namely..... is awarded to the above firm, we shall be able to provide overdraft/ credit facilities to the extent of Rs..... to meet their working capital requirements for executing the above contract.

Name of Bank :

Senior Bank Manager:

Address of the Bank:

ANNEXURE IX**DETAILS OF LITIGATION, IF ANY**

| Sl. No | Name of the Govt. Dept. / Private Organization (Other party) | Cause of the litigation | Amount involved (Rs. In lakhs) | Award for (or) against bidder | Remarks / present stage |
|---------------|---|--------------------------------|---------------------------------------|--------------------------------------|--------------------------------|
| | | | | | |
| | | | | | |
| | | | | | |
| | | | | | |
| | | | | | |
| | | | | | |
| | | | | | |
| | | | | | |

Note: Should be attested by the Notary Public.

Seal of the firm

Signature of the bidder with date

ANNEXURE X

DECLARATION BY THE BIDDER:

It is to certify that our firm
.....has **not** been black listed / banned / debarred by any Central /
State, Union Territory Government Department or undertaking / Organization.

Seal

.....
.....

(Signature of the Bidder)

ANNEXURE XI**DETAILS OF COMPONENTS PROPOSED TO BE SUBLET AND
SUB CONTRACTORS INVOLVED**

| Sl. No | Name of component proposed to be sublet | Name of the sub contractor | Details of experience in similar work | Annual turnover for the last 5 years (Rs. In lakhs) |
|-------------------|--|---|--|--|
| | | | | |
| | | | | |
| | | | | |
| | | | | |
| | | | | |
| | | | | |
| | | | | |
| | | | | |

Seal of the firm

Signature of the bidder with date

ANNEXURE XII**TECHNICAL STAFF TO BE EMPLOYED**

I/We shall/Will employ the following technical staff as per the prescribed rules

| Sl. No. | Name of the technical staff to be employed | Designation | Qualification |
|--------------------|---|--------------------|----------------------|
| | | | |
| | | | |
| | | | |
| | | | |
| | | | |
| | | | |
| | | | |
| | | | |
| | | | |
| | | | |
| | | | |
| | | | |
| | | | |
| | | | |

Seal of the firm

Signature of the bidder with date

VII- GENERAL CONDITIONS OF CONTRACT

1. DEFINITIONS

In the Contract (as hereinafter defined) the following words and expressions shall have its meanings hereby assigned to them, except where the context otherwise requires.

“Board” means Orissa Water Supply and sewerage Board, a statutory body constituted under OWSSB Act 1991 having its office at Satyanagar, Bhubaneswar 751 007 and any officer authorised to act on its behalf

“Employer” means the Orissa Water Supply and sewerage Board and shall include the officers duly authorised to act on its behalf

“Contractor” means the person or persons, firm or company whose tender has been accepted by the Employer and includes the authorised representatives, successors, heirs, executors, administrators

“Subcontractor” means any person or persons, firm or company named in the Contract as a Subcontractor for a part of the Works or any person or persons, firm or company to whom a part of the Works has been subcontracted with the consent of the Engineer and includes the authorised representatives, successors, heirs, executors, administrators of such Subcontractors

“Engineer” means the Project Engineer or any other Engineer appointed from time to time by the Employer to act as Engineer for the purposes of the works brought under this contract

“Engineer in charges” means the Executive Engineer or any other Engineer authorised by him.

“Engineer’s representative” means any Resident Engineer or assistant of the Engineer or any clerk of works appointed from time to time by the Employer or/the Engineer to perform the duties set forth in respect of this Contract.

“Contract” means the Invitation for Bids and amendment made thereof, Letter of Acceptance, the formal Agreement executed between the Employer and the Contractor together with the documents referred to therein, General Conditions of the Contract, Special Conditions, Specifications, Minutes of the pre Bid conference, Design, Drawings, Schedule of Rates and Prices, Bill of quantities, Rate of Progress etc., All these documents taken together shall be deemed to form one contract and shall be complementary to one another

The quality parameters laid down in relevant BIS, CPHEEO, Bid Documents etc., are to be followed and it is stipulated to complete the entire works in all respects satisfactorily and commission within the stipulated period and maintain the scheme for the specified period.

“Contract Price” means the sum stated in the Letter of Acceptance as payable to the contractor for the execution, completion and maintenance of the works, subject to such additions thereto or deductions there from as may be provided under this Contract and the remedying of any defects therein in accordance with the provisions of the contract.

“Constructional Plant” means all appliances or things of whatsoever nature required in or about the execution, completion or maintenance of the works but does not include materials or other things included to form or forming part of the permanent works.

“Works” shall include both permanent works and temporary works. “Permanent works’ means the works of permanent nature to be executed, completed and maintained (including Plant) in accordance with the contract. ‘Temporary works’ means all temporary works of every kind required in or about the execution, completion or maintenance of the works and remedying of the defects therein

Specification” means the schedules, detailed designs, technical data, performance Characteristics and all such particulars referred to in the bid/contract and any modification thereof or addition thereto as may from time to time be furnished or approved by the Employer.

Drawings” means the drawings, calculations and technical information referred to in specification and any modification of such drawings approved in writing by the Engineer and such other drawings, calculations and technical information as may to time be furnished or approved in writing by the Engineer.

“Site” means the land and other places on, under, in or through which the Permanent works and/or Temporary Works are to be executed and any other lands and places provided by the Employer for working space or any other purpose as may be specifically designated in the Contract as forming part of the site.

Approved means approval in writing including subsequent written confirmation of previous verbal approval

“Test” means such test or tests as are prescribed in the specifications or considered necessary by the Engineer

‘ISS” means Indian Standard Specifications

“BIS” means Bureau of Indian Standards

“Day” means a Calendar day from midnight to midnight

“Week” means seven consecutive days.

“Month” means from the beginning date of a given date of a calendar month to the end the preceding date of the next calendar month

“Quarter” means a period of three months reckoning from the 1st date of January April, July and October and counted to the last date of March, June, September and December respectively.

Rupees means Rupees in Indian Currency

“Bill of Quantities” means the priced and completed bill of quantities forming part of the tender

“Tender” means the Contractor’s priced offer to the Employer for the execution, completion and maintenance of the Works and the remedying of any defects therein in accordance with the provisions of the Contract, as accepted by the Letter of acceptance

Letter of Acceptance” means the formal acceptance by the Employer of the Tender

“Contractor Agreement” means the contract agreement referred to in clause(..)

Appendix to Tender” means the appendix comprised in the form of Tender annexed in these conditions.

“Commencement Date” means the date of signing the agreement or the date of handing over the site to the successful firm/contractor, whichever is earlier and this shall be reckoned as the start date of the project.

“Time of Completion” means the time for completing the execution of and passing the Tests on Completion of the Works of any section or part thereof as stated in the Contract (or as extended under Clause...) calculated from the Commencement Date

“Trial run” means the successful Trial run of the completed and commissioned project as a whole or in parts as the case may be for the stipulated period

2. Interpretation

In interpretation of these Conditions of Contract, headings shall not be deemed part thereof or be taken into consideration. Words importing persons or parties shall include firms and corporations and any organization having legal capacity. Words importing the singular only also include plural and vice versa where the context requires.

The Employer will provide instructions clarifying the queries about the contract

3. Authority of Engineer in Charge

It shall be accepted that the authority of the Engineer in charge shall be an integral part of the contract in all matters regarding the quality of materials, workmanship, removal of improper work, interpretation of the contract drawings and specifications, mode and procedure of carrying out the works where the decision of the Engineer in charge shall be final and binding on the contractor. The Engineer in charge shall have absolute authority on all technical matters and payment considerations.

4. Sufficiency of Bid

The Contractor shall be deemed to have satisfied himself as to the correctness and sufficiency of the bid and of the rates and prices stated in the Bill of Quantities, all of which shall, except insofar as it is otherwise provided in the contract, cover all his obligations under the Contract (including those in respect of the supply of goods, materials, Plant or services or of contingencies for which there is a Provisional Sum) and all matters and things

necessary for the proper execution and completion of the Works and the remedying of any defects therein.

5. Priority of Contract Documents

The several, documents forming the Contract are to be taken as mutually explanatory of one another, but in case of ambiguities or discrepancies the same shall be explained and adjusted by the Engineer who shall thereupon issue to the Contractor instructions thereon and in such event, unless otherwise provided in the Contract. The priority of the documents forming the Contract shall be as follows:

- The Contract Agreement
- The Letter of Acceptance
- The Tender
- Conditions of the Contract
- Technical specifications
- Any other document forming part of the Contract

6. Secrecy of the contract document

The Contractor shall treat all documents, correspondence, direction and orders concerning the contract as confidential and restricted in nature by the contractor and shall not divulge or allow access to these matters to any unauthorized person.

7. Instruction in Writing

Instructions given by the Engineer or Engineer's Representative shall be in writing, provided that if for any reason, the Engineer or the Engineer's Representative considers it necessary to give any such instruction orally, the Contractor shall comply with such instruction. Confirmation in writing of such oral instruction given by the Engineer or Engineer's Representative, whether before or after the carrying out of the instructions given by the Engineer or Engineer's Representative, shall be deemed to be an instruction.

8. Commencement of Works

The Contractor shall commence preliminary works after the receipt by him of the LOA to this effect from the Engineer in charge. Thereafter, the contractor shall proceed with the Works with due expedition and without delay and in accordance with the programme schedule set out in the Contract.

9. Reference Marks

The basic center lines, reference points and bench marks shall be fixed by the Engineer in charge of the works.

The contractor shall establish additional reference points and bench marks as may be necessary at his cost. The contractor shall remain responsible for the accuracy and sufficiency of the reference and bench marks. The contractor shall take proper precautionary steps to ensure that the reference lines and bench marks established for the works are not disturbed and shall make good any damages caused.

10. Supervision

The Contractor shall provide all necessary superintendence during the execution of the works and thereafter as may be necessary for the proper fulfillment of the obligations under this contract. The contractor shall arrange for the deployment of proper qualified personnel at the site of work constantly, such supervising staff, apart from those separately set out as the requirements of the contract, shall be skilled and experienced technical assistants, foremen and others competent enough to produce proper supervision.

The Contractor shall employ the technical staff as per the prescribed rules. The details of value, scale and minimum qualification prescribed for the employment of technical staff, the rate of penalty for the failure on the part of the contractor to employ the technical staff for the work etc are as follows

| Sl. No | Scale and minimum qualification prescribed for the employment of technical staff | No. of persons required | Rate of Penalty |
|--------|---|-------------------------|--------------------------------|
| | Above Rs. 1.00 Crore to 50.00 Crore. | | |
| 1) | Project Manager BE (Civil) or equivalent with 15 years experience. | 1 | Rs.25000/- per month / Person. |
| 2) | Deputy Project Manager BE (Civil) or equivalent with 10 years experience | 1 | Rs.15000/- per month / Person. |
| 3) | Resident Engineer BE (Civil) / Mechanical / Electrical or equivalent with 5 years experience | 2 | Rs.10000/- per month / Person. |

If the contractor fails to employ the technical staff to the departmental requirements, the contractor is liable to pay the penalty as indicated above during the period of such non employment of technical staff.

In the event of any staff of the contractor being non co-operative, negligent, incompetent or misconduct, the Engineer in charge shall have the liberty to object to the placement of such staff at the site or other place of works and will promptly issue notice in writing to the

contractor for the removal of such staff members. It will be obligatory on the part of the contractor to remove/change such persons in the larger interests of the works.

11. Subletting of Contract

Assignment of the contract is not permissible

Transfer of the contract is not permissible on any grounds

The contractor shall sublet any portion of the contract only with the written consent of the Engineer in charge. It should be clearly understood that any subletting shall in no way absolve the contractor of his responsibilities and obligations under this contract

12. Specifications and Checks

Stated dimensions in the drawings are to be taken for consideration and no measurements based on scaling of the drawings shall be considered. In case of discrepancy between the description of items in the schedule of quantities and the specifications, the later shall prevail. In case of the description, any work having not fully described or doubts prevail, the contractor shall forthwith write to the Engineer in charge and clarify himself before executing that portion of the work. However, this cannot be a cause for any delay in the progress and the contractor should take advance action in this regard ensuring timely completion of the works. Before commencement of the work, it will be obligatory on the part of the contractor to furnish a detailed plan of action along with layouts showing the position of the construction plants and other facilities required and proposed to be provided for this contract.

The contractor shall execute the works true to alignment, grade and levels as set out in the drawings and as directed by the Engineer in charge from time to time. The Engineer in charge or his representative is at liberty to check the correctness of the works, the suitability of the materials used, design mix etc., The contractor will raise no objections for such checks and shall provide necessary labour and instruments to carry out such check to the Engineer in charge as well as his representative and co-operate in the checks. However, such checks will not absolve the contractor of his responsibility of maintaining the accuracy of the work.

13. Custody and Supply of Drawings and documents

The drawings shall remain in the sole custody of the Engineer in charge, but two copies thereof shall be provided to the contractor free of charge. The contractor shall make at his own cost any further copies required by him. Unless it is strictly necessary for the purposes of the contract, the drawings specifications and other documents provided by the Employer or the Engineer in charge shall not, without the consent of the Engineer in charge, be used or communicated to a third party by the contractor. One copy of the Drawings, provided to or supplied to the Contractor as aforesaid, shall be kept by the Contractor at the site and the same shall be made available for inspection and use by the Engineer and by any other person authorized by the Engineer.

14. Bill of Quantities

The Bill of quantities shall contain items for the construction, installation, testing, commissioning and Trial run of the Works to be carried out by the Contractor.

The Bill of Quantities will be used to calculate the Contract Price. The contractor shall be paid for the quantum of work done at the rate mentioned for each item in the Bill of quantities

15. Change in the Quantities

If the final quantity of the work done differs from the quantity in the Bill of Quantities for the particular item/items, the rates as in the agreement for the relevant items shall be paid as per the actual quantity.

16. Additional items

If additional items that are not contemplated in the contract are to be executed, the Engineer in charge will execute the works either through the main contractor/firm or through any other agency. Payment for such works shall be made based on the rates derived by the Engineer in charge as per rules in force.

17. Order Book

An order book will be kept by the Officer in charge of the site (Junior Engineer/Assistant Engineer) of the particular component of the works. Orders entered in this book by the Engineer in charge or any higher authority shall be held to have been formally communicated to the contractor/firm. The Officer in charge of the site will sign each order as it is entered and will hand over the duplicate to the contractor/firm or his agent, who shall sign the original in acknowledgement of having received the order.

18. Independent Inspection

The Engineer shall delegate inspection and testing of materials or Plant to an independent inspector/Agency. Any such delegation shall be considered as prerogative of the Engineer. In addition to third party inspection, wherever felt necessary, the engineer shall be empowered to test the PVC Pipes for its quality such as specific gravity, diameter, thickness etc. in the TWAD Board laboratory. The cost of the third party quality check pipes, valves and pump sets shall be borne by the employer.

19. Covering and Opening of Works.

No work shall be covered or put out of view without the approval of the engineer in charge. The contractor shall give due notice to the Engineer in charge whenever such works are ready for examination and the Engineer in charge within a reasonable period, arrange for the inspection and measuring of the work as may be necessary. No portions of the work shall be covered up without the consent of the Engineer in charge. The cost of opening any portion of the works that was covered without the consent of the Engineer in charge and the cost of covering thereafter shall be borne by the contractor. The contractor shall open the covered portion of the works for inspection by the Engineer in charge on a request and the inspection or examination shall be carried out promptly by the Engineer in charge. In the case of defects notified by the Engineer in charge, the contractor shall rectify the same as may be instructed by the Engineer in charge. All costs of opening, covering and rectification shall be on to the account of the contractor. Should the contractor refuse to open such portions of works the Engineer in charge shall open such portions with other persons and inspect the part of the works as he may feel necessary. On inspection, the works being not in accordance with the requirements of the contract documents, the Engineer in charge shall

carry out necessary rectification and the entire cost of opening, rectification and closing shall be on to the contractor's account.

20. Temporary Diversion of Roads and Commencement of Work.

During execution of the works, the contractor/firm shall make at his cost all necessary provision for the temporary diversion of roads, car tracks, foot paths, drains, water courses, channels etc., Should the contractor/firm fail to do these arrangements, the same shall be done by the Engineer in charge and the cost thereof shall be recovered from the contractor/firm.

21 Notice to Telephone, Railway and Electric Supply Undertaking.

The Contractor/firm shall give all notices required by any law or custom or as directed by the Engineer in charge and irrespective of whether notice be so required so directed or not, shall in all cases give due and sufficient notices to all persons and authorities having charge of the telegraph, water and other pipes, sewers, culverts drains, water courses, railway, telephone, highways, roads, streets, foot and carriage highways, payment and other works, prior to commencements and at the completion of any work under this contract in order to enable the proper bodies or persons in respect of the matters aforesaid to attend and see the works within their jurisdiction and all matters and things incidental and pertaining thereto are secured, re-laid or reinstated in a proper and satisfactory manner. The notices by the contractor/firm shall also serve the purpose of enabling such bodies and persons to attend and secure, shore up, alter the position or remove, relay and reinstate the works and things belonging to them notwithstanding the notices given as aforesaid the Contractor/firm shall be chargeable and responsible for the proper protection and restoration of all matters and things herein referred to.

22 Watching and Lighting

The Contractor/firm shall at his expense shall provide at the site of works sufficient fencing, barricading, watching and lighting during day and night. The contractor/firm shall in every respect conform to the police regulations in these matters and shall free and relieve the Board on all such matters. Should the contractor/firm fail/neglect to do these arrangements, the same shall be carried out by the Engineer in charge and the costs thereof shall be recovered from the contractor/firm.

23 Measurement of Work

The work will be measured by the site engineer (Junior Engineer/Assistant Engineer) and recorded in the measurement book. The contractor/firm will be at liberty to accompany the site engineer in order that they may agree on the measurements but should they neglect to do so, the measurements as recorded by the site engineer shall be taken as final and conclusive. The measurements of works will be recorded as prescribed in the TNBP and as amended from time to time.

24 Tools and Plants

All tools, plants and equipment required for this contract will be arranged by the Contractor at his own expense. The Contractor shall erect necessary construction plant as may be necessary and shall use such methods and appliances for the proper performance of all the

operations connected with the work brought under the contract ensuring satisfactory quality of work and maintenance of the programme schedule. The non-availability of any tool, plant or equipment shall not be relied upon as a reason for non-functioning or slow progress.

25 Information and Data

The information and data made available to the contractor in respect of the works and site conditions are only general and the contractor is advised to get himself fully acquainted with the nature of the location of the works and the surroundings, quarries, local conditions and such other aspects that are relevant to the works.

26 Coexistence with other Contractors.

Where two or more contractors are engaged on work in the same vicinity, they shall work together harmoniously with the spirit of cooperation and accommodation. The contractor shall not disrupt or disturb the works or labour arrangements of the neighboring contractors. In case of disputes and difficulties arising between the contractors in the execution of the respective works, the Engineer in charge shall interfere and give directions for the smooth functioning of the entire works and it shall be the bounden duty of the contractors to abide by these instructions.

27 General Responsibilities and Obligations of the Contractor

The contractor shall, subject to the provisions of the contract, execute and maintain the works with proper care and diligence and provide all labour including the supervision thereof, materials, constructional plant and all other things, whether of a temporary or permanent nature required for such execution and maintenance.

The contractor shall take full responsibility for the adequacy, stability and safety of all site operation and methods of construction.

The contractor shall promptly inform the Employer and the Engineer in charge if any error omission, fault and other defects in the specification or design of the works which are identified at the time of reviewing the contract documents or during the execution for proper rectification thereof.

All notices, certificates connected with the work served by the employer relating to the contract shall be sent by post or by hand to the contractor' principal place of business as mentioned in the document or at other places as may nominated by the contractor in writing for this purpose. Any change in the address of the contractor should be promptly intimated to the Employer in writing then and there.

The contractor shall visit the spots of work and ascertain the site conditions. The contractor shall satisfy himself of the conditions prevailing in the spots where the work is actually to be executed and its environs and the precise offered by him shall be treated as those which were worked out taking fully into consideration the prevailing site conditions, hydrological conditions, extent and nature of work to be executed, the material availability, etc., Any claim on this ground at a later date shall be summarily rejected.

However, during the execution of the works, if the contractor has to encounter artificial obstructions, which in his opinion could not have been reasonably foreseen, then the

contractor shall write forthwith to the Engineer in charge of such obstruction and remedial measures needed. The Engineer in charge, if opined that the conditions cannot be possibly foreseen by an experienced contractor, he shall extend possible assistance to the contractor to overcome such obstructions. The opinion of the Engineer in charge shall be final and binding and the contractor is not entitled to advance these as reasons for any delay that may be caused to the completion of the project.

The contractor shall execute and maintain all works in accordance with the specification and to the satisfaction of the Employer. The contractor shall strictly adhere to the instructions and directions of the engineer in charge, whether included in the contract agreement or not but concerning the safe and proper execution of the works.

28 Labour

The contractor shall not employ any person who has not completed fifteen years of age in connection with the works under this contract.

The contractor shall furnish the information on various categories of labour employed by him to the Engineer in charge in the form prescribed for this purpose

The contractor shall in respect of labour employed by him comply with or cause to be complied with the provisions of various labour laws, rules and regulations as applicable to them in regard to all matters provided therein and shall indemnify the Employer in respect of all claims that may be made against the Employer for non-compliance thereof by the contractor.

Now withstanding anything contained herein, the Employer reserves the right to take such action as may be deemed fit and proper for the compliance of various labour laws and recover the costs thereof from the contractor.

29 Restriction of Working Hours

Subject to any provisions contained in the Contract, none of the works shall, save as hereinafter provided, be carried on during the night or on locally recognized days of rest without the consent of the Engineer, except when work is unavoidable or absolutely necessary for the saving of life or property or for the safety of the Works, in which case the Contractor shall immediately advise the Engineer, Provided that the provisions of this clause shall not be applicable in the case of any work which is customary to carry out by multiple shifts

30. Right of Way and Facilities

The Contractor shall bear all costs and charges for special or temporary rights of way required by him in connection with access to site. The Contractor shall also provide at his own cost any additional facilities outside the Site required by him for the purposes of the Works

31. Removal of Improper Work, Material and Plant

The contractor shall make his own arrangements for the procurement, supply and use of the construction materials and shall ensure that the materials either procured within the country or abroad conform to the relevant specifications set out in the bid documents. In case of alternatives being used, they should be of equal or higher quality than those specified subject to the review and written approval of the Engineer in charge. Differences between the standards specified and the proposed alternatives must be described in writing to the Engineer in charge at least 30 days in advance from the date on which the approval of the Engineer in charge is needed. The disapproval of the proposal by the Engineer in charge shall result in the contractor confining to the standards set forth in the contract documents. The contractor shall arrange for the inspection of the material at the manufacturing place or other places by the department personnel

All materials and workmanship shall be in accordance with the specifications set out in the contract document and as directed by the Engineer in charge and shall be subjected to tests by the Engineer in charge or his representative at the place of manufacture or at the site of work or places wherever felt necessary. The contractor shall provide all the assistance necessary including instruments, machines and materials that are normally required for carrying out the testing/measuring the quality/quantity of the materials and workmanship. Any material rejected after testing by the Engineer in charge or his representative will not be used on the works. The contractor shall without claiming any extra cost, shall arrange for the testing of materials and supervision of the works. The Engineer in charge or his authorized representative will have access at all times to the places of manufacture, storage to ascertain as to whether the manufacturing process wherever mentioned is in accordance with the drawings and specifications

The Engineer in charge shall have the right to order the removal of such materials which in his opinion are substandard stipulating a time limit for the removal of the same and replacement with quality material

Notwithstanding the previous tests of the materials by the Engineer in charge or his representative, if any portion of the work, in the opinion of the Engineer in charge is not in order, the contractor shall redo such work to the satisfaction of the Employer at no extra cost. In case of default on the part of the contractor in carrying out such orders, then the Employer shall have the right to carry out such works through some other persons and the expenses thereon or incidental thereto shall be recoverable from the contractor.

32. Default of Contractor in Compliance

In case of default on the part of the Contractor in carrying out such instruction within the time specified therein, if none, within a reasonable time, the Employer shall be entitled to employ and pay other persons to carry out the same and all costs consequent thereon or incidental

thereto shall after due consultation with the Employer and the Contractor, be determined by the Engineer and shall be recoverable from the Contractor by the Employer, and shall be deducted by the Employer from any monies due or to become due to the Contractor and the Engineer shall notify the Contractor accordingly, with a copy to the Employer

33. Default by Contractor

If the contractor shall become bankrupt or have a receiving order made against him or shall present his petition in bankruptcy or shall make an arrangement with or assignment in favour of his creditors or shall agree to carry out the contract under a committee of inspection of his creditors, or being a corporation shall go into liquidation (other than a voluntary liquidation for the purpose of amalgamation or reconstruction), or if the contractor shall assign the contract, without the consent in writing of the employer first obtained, or shall have an execution levied on his goods, or if the engineer in charge shall certify in writing to the employer that in his opinion, the contractor.

- a) Has abandoned the contractor or
- b) Without reasonable excuse has failed to commence the works or has suspended the progress of work for twenty eight days after receiving a written notice from the Engineer in charge to proceed or
- c) Has failed to remove materials from the site or to pull down and replace work for twenty eight days after receiving the written notice from the engineer in charge stating that the said materials or work stands condemned and rejected under these conditions, or
- d) Despite previous warnings in writing by the Engineer in charge, not executing the works and achieving the progress as stipulated in the programmed schedule drawn for the contractor is persistently or flagrantly neglecting to carryout the obligations under this contractor
- e) Has, to the detriment of good workmanship, or in defiance of the instructions of the Engineer in charge or in contract sublet any part of the contract, then the Employer, may at his option, after giving two weeks' notice in writing to the contractor, enter upon the site and the works and expel the contractor therefrom without thereby voiding.
- f) The contract, or releasing the contractor from any of his obligation or liabilities under this contract, and may himself complete the works or may employ any other contractor to complete the work. The employer or such other contractor may use the construction plant, temporary works and materials which have been deemed to be reserved exclusively for the execution of the works under the provisions of the contract as may be thought fit and proper for the completion of the work. The employer may, at any time, sell any of the said constructional plant, temporary works and materials which have been deemed to be reserved exclusively for the execution of the works under the provisions of the contract as may be thought fit and proper for the completion of the work. The employer may, at any time, sell any of the said constructional plant, temporary works and unused materials and apply the proceeds of sale in or towards the satisfaction of any sums due or which may become due to him from the contractor under this contract.

- g) has carried out the work in a defective manner.
- h) has not made payment of labour dues.
- i) has become eligible for maximum compensation under the "Liquidated damages clause" leading to Termination of the contract.

The *Engineer in charge* shall as soon as may be practicable after any such entry or expulsion by the employer, fix and determine expert or by after reference to the parties, or after such investigation or enquiries as maybe thought fit to make or institute, and shall clarify what amount, if any had at the time of such entry and expulsion been reasonably occurred to the contractor in respect of work then actually done by him under this contract and the value of any of the said unused or partially used materials, any constructional plant and any temporary woks.

If the employer shall enter and expel the contractor under this clause, the employer shall not be liable to pay to the contractor any money on account of the contract until the expiration of the period of maintenance and thereafter until the costs of execution and maintenance, damages for delay in completion, if any and all other expenses incurred by the Employer have been ascertained and the amount thereof certified by the engineer. The contractor shall then be entitled to receive only such sum or sums, if any as the engineer in charge may certify would have payable to him upon due completion by him after deducting the said amount. If such amount shall exceed the sum which would have been payable to the contractor on due completion by him, then the contractor shall, upon demand, pay to the employer the amount of such excess and it shall be deemed a debt due by the contractor to the Employer and shall be recoverable accordingly.

If, by reason of any accident, or failure, or other event occurring to or in connection with the work, or any part thereof, either during the execution of the works, or during the period of maintenance, any remedial or other work or repair shall in the opinion of the Engineer in charge or his authorized representative, be urgently necessary for the safety of the works and the contractor is unable or unwilling at once to do such work or repair as the Engineer in charge or his representative may consider necessary, such works shall be carried out by the Engineer in charge. If the work or repair so done, which in the opinion of the Engineer in charge, liable to have been done by the contractor at his expense under this contract, all expenses incurred by the Employer in carrying out such works shall be recoverable from the contractor or shall be deducted by the Employer from the money due to the contractor provided always that the Engineer in charge or his representative, as the case may be, shall as soon after the occurrence of any such emergency as may be reasonably practicable, notify the contractor thereof in writing.

34. Power to vary work

The description of the works required to be executed by the contractor/firm are set out in the specifications, schedules and drawings, but the Engineer in charge reserves the power to vary, extend or diminish the quantities of work, to alter the line, level or position of any work, to increase, change or decrease the size, quality, description, character or kind of any work, to order the contractor/firm to execute the works or any part thereof, by day or night work, or to add or take from the work included in the contract as he may deem fit and proper without violating the contract and the contractor/firm shall not have any claim upon the Employer for any such variation, extension, diminution, alteration, increase, change or

decrease other than for the work actually done, calculated according to the prices tendered and accepted in this contract.

35. Extra for Varied Works

Any unforeseen additional work that may become necessary and is accordingly carried out under this contract based on proper written orders shall be measured and valued by the Engineer in charge at the rates contained in the contractor's/firm's original bill of quantities. If these rates do not apply to the additional works ordered to be carried out, then prior to execution of the additional work, a rate for such work shall ordinarily be agreed upon and entered in a supplemental schedule and signed by both the Engineer in charge and the contractor/firm.

36. Omissions

In the event of anything reasonably necessary or proper to the due and complete performance of the work (Engineer in charge will be the sole judge on these things) being omitted to be shown or described in the drawings, specifications and schedules, the contractor/firm shall notwithstanding execute and provide at the rates noted in the bill of quantities all such omitted works and things as if they have been severally shown and described and the execution should be according to the directions of the Engineer in charge and to his satisfaction.

37. Notices Regarding Shoring etc.,

Wherever shoring or other works for the protection or security of the buildings/structures are necessary, the contractor/firm shall within a reasonable period before the execution of such works, shall serve notices upon the occupiers of the buildings / structures to be shored up or otherwise secured and upon all other parties entitled to notice, apprising them respectively that such works are necessary, that the contractor/ firm about to execute the same and will, at a time to be specified in such notice, enter upon the premises for the purpose of executing such works.

38. Cost of Repairs

Loss or damage to the Works or materials to be incorporated in the works between the Start Date and the end of the Defects correction periods shall be remedied by the Contractor at the Contractor's cost if the loss or damage arises from the Contractor's acts or omissions.

Contractor shall attend to the defect in the work noticed during defects correction period within 3 days from the date of issue of notice to attend to the defects, failing which the defect will be remedied by engaging other Contractors at any cost and that cost will be recovered from the Contractor's money available with the Employer and balance alone will be paid when it is due.

39. Suspension of Work

The Contractor shall, on the instructions of the engineer, suspend the progress of the Works or any part thereof for such time and in such manner as the Engineer may consider necessary and shall, during such suspension, properly protect and secure the Works or such part thereof so far as is necessary in the opinion of the Engineer in charge.

40. Suspension of Progress

The contractor/firm shall, without recompense, claim or demand, delay or suspend the progress of works as a whole or any part thereof, if and when or so often as directed by the Engineer in charge and for such time or times, as may be in the judgement of the Engineer in charge be necessary for the purposes or advantages of the undertaking. Upon all such occasions, whether directed or not, the contractor/firm at his/their expense, properly cover down and secure so much of the work as may be liable to sustain damage from whether or any other cause and shall at all times and forthwith when required properly make good all the damage or injury which such works or any part thereof may give sustained and these should be done to the entire satisfaction of the Engineer in charge.

41. Termination

The Employer may terminate the Contract for any reason that is regarded as breach of the Contract.

If the contract is terminated, the contractor shall stop work immediately, make the site safe and secure and leave the site as soon as reasonably possible on termination of the contract, the Engineer shall issue a certificate for the value of work done less payments received up to the date of the issue of certificates, less other recoveries due in terms of the contract, less taxes due to be deducted at source as per applicable law and less the percentage to apply to the work not completed. If the total amount due to the Employer exceeds any payment due to the Contractor the difference shall be treated as debt payable to the Employer and can be recovered from any amount due or may become due to the contractor.

In the case of termination, works that are pending for the proper completion of the project, shall be carried out by the Employer either by themselves or through any other agency. Any additional expenditure over the value finalised in the contract for any component or for the whole project, incurred by the Employer by the Employer due to such termination, shall become recoverable from the contractor/firm whose contract stands terminated, from the money due or may become due to him/them. All materials on the Site, Plant, Equipment, Temporary Works and Works are deemed to be the property of the Employer, if the Contract is terminated because of Contractor's default

42. Plant etc. not to be removed

The plant, tools and materials provided by the contractor/firm shall, from the time they are brought to the site of the works, during the construction and until the satisfactory completion of the contract, shall become and continue to be the property intended for the proper fulfillment of the contract and the contractor/firm shall not remove the same or part thereof without the consent of the Engineer in charge in writing.

43. Contractor not to occupy Land etc.,

In no case shall the contractor/firm continue to use or occupy or allow to be used or occupied any land or property either for the deposit of materials or plant or for any purpose whatever, after written notice from the Engineer in charge served on the contractor/ firm to the effect requiring the contractor/firm to remove or cause to be removed all such materials from any such land or property as aforesaid and to give vacant possession of such land or property to the Engineer in charge. All such notices shall be served through post office or other modes of delivery to the contractor/firm at his/their usual or last known place of business, It is enough for the Engineer in charge to send the notice through any mode of delivery as he may prefer and implement this clause irrespective of the receipt of the notice by the contractor/firm. Should any materials or plant remain upon any such property or land or should any such land or property continue to be occupied or be used after such notice for any purpose whatsoever as aforesaid, then and in every such case and as often as the same shall happen, the contractor/firm shall forfeit and on demand pay to the Employer the charges fixed by the Engineer in charge as and for liquidated and ascertained damages for each and every day during which the said lands or property are so used and occupied as aforesaid from the time of such notice shall have been served.

44. Power Supply

The power supply connection from the NESCO has to be obtained by the contractor himself and the charges thereon shall be borne by the contractor. However, necessary vouchers in original for the payment made to the NESCO shall be produced to the Employer by the contractor which will be reimbursed by the Employer.

45. Completion and Delivery of the Works

The completion and delivery of the works shall be deemed to be full, complete and sufficient only when the Engineer in charge accepts the same and issues a certificate in writing viz. " Certificate of Completion" under the hand of the Engineer in charge to the effect that all the works contracted for and directed to be executed have been completed and are in a sound, water tight, workmanlike and complete and usable condition and the contractor has in the opinion of the Engineer in charge reasonably fulfilled and completed his contract and undertaking except so far as it relates to the maintenance of the works as hereinafter provided. Provided always and notwithstanding anything contained in the contract, it shall be lawful for the Employer to undertaker and execute either departmentally or through other parties at any period during the continuance of this contract, any kind of work, matter or thing whatsoever, which they mat consider necessary or proper to be performed and executed for the purpose of any in connection with any or all of the works under this contract and that without in any way relieving the contractor/firm from any of his/their liabilities and responsibilities under this contract or in any way violating or voiding this contract.

46. Final Certificate

When the works covered under this contract are completed in all respects, the contractor / firm shall submit a request to the Engineer in charge to make a final measurement of the works and take over the whole of the works on behalf of the Employer

and issue a final certificate to enable him/them to submit a final bill for payment. The Engineer in charge shall thereupon, unless he records reasons in writing to the contrary, make a final measurement of the works and take them over on behalf of the Employer and sign a certificate purporting to be a last certificate. Nothing in this clause or in the agreement shall prohibit the Employer taking over and using any portion of the works which may be completed prior to the completion of the whole works of this contract.

47. Completion Certificate

The Contractor shall request the Engineer to issue a certificate of Completion of the Works and the Engineer shall issue certificate of completion after satisfactory completion of the works in all respects

48. Taking Over

The Employer shall take over the Site with the works within thirty days after satisfactory completion of the trial run of the entire project for the stipulated period as contemplated in this contract.

49. Performance Guarantee

The period of guarantee for the entire works shall be 24 months from the date of completion and commissioning of the project and trial run period to the satisfaction of the Engineer in charge of the work. If defects are noticed during the guarantee period, the firm/contractor shall rectify/replace wherever necessary at its/his own cost within 30 days of such intimation. If the contractor/firm fails to carry out rectification within the stipulated time, the rectification works shall be carried out by the Employer at the risk and cost of the contractor/firm and contractor/firm will become ineligible for the payment of the retention amount for the said purpose.

50. Trial run of the project

The contractor / firm shall successfully maintain the project for the stipulated Trial run period from the successful commissioning of the works in this project.

51. Operating and Maintenance Manual

“As built” drawings and operating and maintenance manuals shall be supplied by the contractor/firm at the time of handing over the completed works at his/their cost as instructed by the Engineer in charge.

52. Work on Private Property

The contractor/firm shall not commence any work in or upon, under, across of through any land, house building, shed, yard, area, roadway, ground, garden or any other place being private property until authorised in writing by the Engineer in charge to do so.

53. Protection

It will be the responsibility of the contractor to take adequate precautions and protect the adjoining sites against structural, decorative and other damages. The contractor shall be responsible for the safety of the public properties wherever the works are executed. Whenever damages are caused to the adjoining structures, roads, bridges etc due to the execution of this contract, it will be the responsibility of the contractor to restore them to their original level at his cost.

54. Accident or Injury to Workmen

The Employer shall not be liable for or in respect of any damages or compensation payable to any workman or other person in the employment of the Contractor or any Subcontractor. The Contractor shall indemnify and keep indemnified the Employer against all such damages and compensation and against all claims, proceedings, damages, costs, charges and expenses whatsoever in respect thereof or in relation thereto

55. Risk Insurance

The firm/Contractor shall provide risk insurance at their/his cost against loss or damages to the construction to cover from the start date to the end of the Defects Liability Period, for the following events

- Loss of or damage to the Works, Plant and Materials
- Loss of or damage to Equipment
- Loss of or damage of property (except the Works, Plant, Materials and Equipment) in connection with the Contract and
- Personal injury or death

Policies and certificates for insurance shall be delivered by the Contractor to the Engineer for the Engineer's approval before the Start Date. All such insurance shall provide for compensation to be payable in the types and proportions of currencies required to rectify the loss or damage incurred. The contractor will not be eligible for any payment on this account.

If the Contractor does not provide any of the policies and certificates required, the Employer shall effect the insurance which the Contractor should have provided and recover the premiums the Employer has paid from payments otherwise due to the Contractor or, if no payment is due, the payment of the premiums shall be a debt due

Alterations to the terms of insurance shall not be made without the approval of the Engineer.

56. Care and Risk

From the date of commencement to the date of completion of the work and during the period of maintenance, the contractor shall take full responsibility and care thereof for the safety of the installation connected with the works. Any damage or loss are to be made good at the risk and cost of the contractor and shall ensure conformity in every respect with the requirements of the contract. The contractor shall be liable for any damage to the works occasioned by him in the course of any operation carried out by him for the purpose of

completing any outstanding work and the damage so occurred shall be rectified at the cost of the contractor.

57. Safety Provisions

The Contractor shall be responsible for the safety of all activities on the Site.

1) Suitable scaffolds shall be provided for workers for all that cannot safely be done from the ground or from solid construction, except such short period work, as can be done safely from ladders. When a ladder is used, an extra mazdoor shall be engaged for holding the ladder and if the ladder is used for carrying materials as well, suitable footholds and handholds shall be provided on the ladder and the ladder shall be given an inclination no steeper than 1\4 to 1 (1\4 horizontal to 1 vertical). IS code for scaffolding and ladders I.S 3696 Part -I and Part II and its latest revisions is to be followed.

2) Scaffolding or staging more than 3.25 meters above the ground or floor swung or suspended from an overhead support or erection with stationary support, shall have guard rail properly attached bolted, braced and otherwise secured at least 1 meter high above the floor or platform of such scaffolding or staging and extending along the entire length of the outside and ends thereof with only such openings as may be necessary for the delivery of materials. Such scaffolding or staging shall be so fastened as to prevent it from swaying from the building or the structure.

3) Working platform, gangways and stairways shall be so constructed that they do not sag unduly or unequally, and if height of a platform or gangways or stairway is more than 3.25 metres above ground level, it shall be closely boarded, having adequate width and be suitably fenced, as described in 2 above. Every opening in floor of a building or in a working platform shall be provided with suitable means to prevent fall of persons or materials by providing suitable fencing or railing with a minimum height of 1 meter. Safe means of access shall be provided to all working platforms and other working places. Every ladder shall be securely fixed. No portable single ladder shall be over 7 metres in length. Width between side rails in a rung ladder shall in no case be less than 30 cm, for ladders, this width shall be increased by at least 6mm for each additional 30cm length. Uniform steps spacing shall not exceed 30cm.

4) Adequate precautions shall be taken to prevent danger from electrical equipment. No material on any of the sites shall be so stocked or placed as to cause danger or inconvenience to any person or to the public. The Contractor shall provide all necessary fencing and lights to protect public from accidents and shall be bound to bear expenses of defence of every suit, action or proceedings at law that may be brought by any person for injury sustaining, owing to neglect of the above precautions and to any such suit, action or proceedings to any such person or which may with the consent of the Contractor be paid to compromise any claim by any such person.

5) All necessary personal safety equipment as considered adequate by the Engineer shall be available for use of persons employed on the site and maintained in a condition suitable for immediate use and the Contractor shall take adequate steps to ensure proper use of equipment by those concerned.

a) Workers employed on mixing asphalt materials, cement and lime mortars /concrete shall be provided with protective footwear, hand gloves and goggles.

b) Those engaged in handling any materials, which is injurious to eyes, shall be provided with protective goggles.

c) Stone breakers shall be provided with protective goggles and protective clothing.

d) When workers are employed in sewers and manholes, which are in use, the Contractor shall ensure that manhole covers are opened and manholes are ventilated at least for an hour before workers are allowed to get into them. Manholes so opened shall be cordoned-off with suitable railing and warning signals or boards provided to prevent accident to public.

e) The Contractor shall not employ men below the age of 15 and women on the work of painting with products containing lead in any form. Whenever men above the age of 18 are employed on the work of lead painting the following precautions shall be taken:

i) No paint containing lead or lead products shall be used except in the form of paste of ready-made paint.

ii) Suitable face masks shall be supplied for use by workers when paint is applied in the form of spray or a surface having lead paint dry rubbed and scraped.

iii) Overalls shall be supplied by the Contractor to workmen and adequate facilities shall be provided to enable working painters to wash during and on cessation of works.

6)When the work is done near any place where there is risk of drowning, all necessary equipment shall be provided and kept ready for use and all necessary steps shall be taken for prompt rescue of any person in danger and adequate provisions shall be made for prompt first aid treatment of all injuries likely to be sustained during the course of the work.

7)Use of hoisting machines and tacks including their attachments, anchorage and supports shall conform to the following:

a) i) These shall be of good mechanical construction, sound material and adequate strength and free from patent defects and shall be kept in good working order.

ii) Every rope used in hoisting or lowering materials or as a means of suspension shall be of durable quality and adequate strength, and free from patent defects

b) Every crane driver or hoisting appliance operator shall be properly qualified and no person under the age of 21 years shall be in-charge of an hoisting machine, including any scaffold winch or giving signals to operator.

c) In case of every hoisting machine and of every chain ring hook, shackle, swivel and pulley block used in hoisting machine or lowering or as means of suspension, safe working load shall be ascertained by adequate means. Every hoisting machine and all gear referred to above shall be plainly marked with safe working load. In case of hoisting machine having a

variable safe working load and the conditions under which it is applicable shall be clearly indicated. No part of any machine or of any gear referred to above in this paragraph shall be loaded beyond safe working load except for the purpose of testing.

d) In case of departmental machine, safe working load shall be notified by the Engineer. As regards Contractor's machine, the Contractor shall notify safe working load of each machine to the Engineer whenever he brings to the site of work and he shall get it verified by the Engineer.

8) Motors, gearing, transmission, electrical wiring and other dangerous parts or hoisting appliance shall be provided with such means so as to reduce to minimum risk and accidental descending of load; adequate precautions shall be taken to reduce to the minimum risk of any part of a suspended load becoming accidentally displaced. When workers are employed on electrical installations, which are already energized, insulating mats, wearing apparel such as gloves, sleeves and boots, as may be necessary shall be provided. Workers shall not wear any rings, watches and carry keys or other materials, which are good conductors of electricity.

9) All scaffolds, ladders and other safety devices mentioned or described herein shall be maintained in a safe condition and no scaffold ladder or equipment shall be altered or removed, while it is in use. Adequate washing facilities shall be provided at or near place of work.

10) The safety provision shall be brought to the notice of all concerned by displaying on a notice board at a prominent place at the work spot, persons responsible for ensuring compliance with the safety provision shall be named therein by the Contractor.

11) To ensure effective enforcement of the rules and regulations relating to safety precautions, arrangements made by the Contractor shall be open to inspection by the Engineer or his representative and the inspecting Officer.

12) The Contractor shall obtain prior permission of the competent authority such as Chief of Fire services for the site, manner and method of storing explosives near the site of work. All handling of explosives including storage, transport shall be carried out under the rules approved by the "Explosive Department of the Government".

13) The Contractor shall at his own cost provide and maintain at the sites of works, standard first aid box as directed and approved by the Engineer, for the use of his own as well as the Employer's staff on site.

14) Notwithstanding the above provision 1 to 15 Contractor is not exempted from the operation of any other Act or rules in force relating to safety provisions.

58. Provision of Health and Sanitary Arrangements

The contractor/firm, shall provide at his/their own expenses, first aid appliances and medicines including an adequate supply of sterilized dressing and sterilized cotton wool kept in good order under the charge of a responsible person who shall be readily available during working hours.

Water of good quality fit for drinking purposes shall be provided for the work people on a scale of not less than 15 litres per head per day. Each water supply storage shall be at a distance of not less than 15 metres from any latrine, drain or other source of pollution. Where water has to be drawn from an existing well which is within such proximity of latrine, drain or other sources of pollution, the well shall be properly chlorinated before water is drawn from it for drinking.

Adequate washing and bathing places shall be provided separately for men and women and such places shall be kept in clean and drained condition. Latrines and urinals shall be provided within the precincts of work place and the accommodation separately for each of them shall be at the rate of 2 seats upto 50 persons, 3 seats above 50 persons but not exceeding 100 persons, and 3 seats for every additional 100 persons. The contractor/firm shall employ adequate number of scavengers and conservancy staff to maintain the latrines and urinals in a clean condition.

Two sheds one for meals and the other for rest shall be provided separately for the use of men and women workers and properly maintained.

All the above amenities shall be provided at the contractor's/firm's own expenses besides providing sheds for his/their workmen.

59. Patent Rights

The Contractor shall save harmless and indemnify the Employer from and against all claims and proceedings for or on account of infringement of any patent rights, design trademark or name or other protected rights in respect of any Contractor's Equipment, material or Plant used for or in connection with or for incorporation in the Works and from and against all damages, costs, charges and expenses whatsoever in respect thereof or in relation thereto.

60. Royalties

Except where otherwise stated, the Contractor shall pay all seignorage and other royalties, rent and other payments or compensation, if any, for getting stone, sand, gravel, clay or other materials required for the Works.

61. Old Curiosities

All old curiosities, relics, coins, minerals and any other item of archeological importance found at the site shall be the property of the Government and shall be handed over to the Engineer in charge for depositing to the Government exchequer. Should any structure be uncovered, the instruction of the Engineer in charge shall be provided before demolition or removal of the structure.

62. Contractor Dying, becoming Insolvent or Insane

In the event of death or insanity of the contractor, the contract may be terminated by notice in writing, pasted at the site and advertised in the issue of the local newspaper. All acceptable works shall thereafter, be paid at appropriate rates after recovering all the

contractor's dues to Employer, to the persons entitled to receive and give a discharge for such payments.

In the contractor is imprisoned because insolvent compound with his creditors has a receiving order made against him or carriers on business under receiver for the benefit of the creditors of any of them or being a corporation goes into liquidation or commences to be wound up not being a voluntary winding up for the purpose only of amalgamation or reconstruction, the employer shall be at liberty.

- a) To give such liquidator, receiver or other persons in whom the contract may become vested the option of carrying out the contract or a portion thereof to be determined by the employer, subject to his providing an appropriate guarantee for the performance of such contractor.
- b) To terminate the contract forthwith by notice in writing to the contractor the liquidator, the receiver or person in whom the contract may become vested and take further actions as provided in the clause pertaining to default by contractor, treating as if this termination is ordered under the respective clause.

63. Force Majeure

The works taken by the contractors under the contract shall be at the contractor's risk until the work is taken over by the Project Engineer. The contractor shall arrange his own insurance against fire, flood, volcanic eruption, earth quake and other convulsions of nature and all other natural calamities, risks arising out of acts of god, Acts of Terrorism, Civil disturbances, Riots during such period and that the OWSSB/Government shall not be liable for any loss or damages occasioned by or arising out of any such acts of God.

Provided however that the contractor shall not be liable for all or any loss or damages occasioned by or arising out of acts of foreign enemies, invasion, hostilities or war like operations (before or after declaration of war) rebellion military or usurped power.

64. Payment out of Public Funds

The payments to the contractor/firm shall be made out of the funds under the control of the Employer in their public capacity and no member or officer of the Employer shall be personally responsible to the contractor/firm.

65. Bribery and Collusion

In the event of the contractor offering or giving any official of the employer, any gift or consideration of any kind as an inducement or regard for doing, or for bearing to do, any action in relation to obtaining or in the execution of the contract or any other contract with the employer, or for showing favour to any person in relation to the contract or any other contract with the employer, or if any of the such acts shall have been done by any person employed by the contractor or acting on his behalf, either with the knowledge of the contractor or not which are all grounds for the employer to terminate the contract awarded to the contractor. Similarly, if the contractor colludes with another contractor or number of contractors whereby an agreed quotation or estimate shall be offered as a bid, that will also form the basis for the employer to terminate the contract.

66. Technical audit

It is a term of this contract that department shall have the right to carry out post payment audit and technical Audit by the Engineers of Technical audit cell (or by an approved consultant of repute). The Technical audit officer shall have the powers to inspect the work or supply running account bill, final bill and other vouchers, measurement books, test reports and other documents either during progress of work or after completion of the same and order recoveries from the contractor for recorded reasons even though the contractor might have been paid earlier. These recoveries are enforceable against the contractor from any amount due to him, from performance security or withheld amounts or any amounts due to the contractor or may become due to him from the department in any work or supply.

67. Settlement of dispute

a. Dispute Redressal Committee

In order to ensure a dispute Redressal mechanism, a Committee headed by
OWSSB for each package in order to resolve any disputes between the Employer / Engineer – in charge concerned and the contractor

b. Jurisdiction of Court

In the event of non-settlement of any dispute by the Dispute Redressal Committee arising between the parties hereto in respect of any matter comprised in the contract, the same shall be settled by a competent court having jurisdiction over the place where the contract is awarded and agreement is concluded and by no other court.

68. Reservation of Right

The Employer reserves the right to accept or reject any or all the bids and to annul the entire process of bidding at any time. Under such circumstances, the Employer will neither be under any obligation to inform the bidders of the grounds for the action of the Employer nor the Employer will be responsible for any liability incurred by the bidder on this account.

SPECIAL CONDITIONS OF CONTRACT**Construction period of the contract – 9 Months****Trial run of the scheme – 3 Months**

1. The Contractor shall, except as stated below, be responsible for the provision of all electricity power, water, gas, consumables, chemicals and other services he may require. During Trial run of the Works, the **Contractors shall be responsible for the provision of all water, gas, consumables, chemicals, other services and all spares and tools** not listed in Schedule of Technical Particulars T11 but actually be required for the Works. **The electricity power cost as related to the normal operation and maintenance and trial run of the Works shall be borne by the Contractor.**

Unless otherwise stated in the Conditions of Particular Applications of the Works, monthly progress reports shall be prepared by the Contractor and submitted to the Engineer in six copies. The first report shall cover the period up to the end of the first calendar month following the commencement date of that Section. Reports shall be submitted monthly thereafter, each within 7 days after the last day of the period to which it relates.

Reporting shall continue until the Contractor has completed all works which are known to be minor outstanding at the completion dates stated in each of the Taking-Over Certificate of the Works.

Each report in trial run of the Works shall include:

- (a) Photographs showing status of each equipment, plant, civil structures at all sites of the Works;
- (b) Logs to show the maintenance record to all equipment;
- (c) Logs to show the replacements of damage and defective components of each equipment or the whole equipment of a Plant;
- (d) Logs to show the attendance records of all the operation and Maintenance staff; and
- (e) Comparisons between the recommendations from the Operation and Maintenance Manual with the actual maintenance, defective parts replacement records as described in (c) and (d) above.

2. Contractor's Operations on Site:

Upon the issue of the Taking-Over Certificate of the Works, the Contractor will be handed over the whole Works by the Employer such that the whole Work will be under possession by the Contractor. The Contractor shall be responsible for all works that are required for possession of the whole Works.

3. General Design & Obligations:

The requirements to As-Built Documents of the Works are described in Part A – General Specification of the Contract. The requirements to Operation and Maintenance Manuals of the Works are described in Part A – General Specification of the Contract.

The Contractor shall allocate his operation and maintenance staff at the Works every day to conduct operation and maintenance work to the Works, in multiple shifts, with details as specified in the Employer's Requirement Facilities for Staff and Labour Save insofar as the Contractor may otherwise provide, the Contractor shall provide and maintain such accommodation and amenities as he may consider necessary for all his staff and labour, employed for the purposes of or in connection with the Contract, including all fencing, water supply (both for drinking and other purposes), electricity supply, sanitation, cookhouses, fire prevention and firefighting equipment, cookers, refrigerators, furniture and other equipment in connection with such accommodation or amenities. On completion of the Contract, unless otherwise agreed with the Employer, the temporary camps/housing provided by the Contractor shall be removed and the site reinstated to its original condition, all to the approval of the Engineer.

4.Reservation of Right

The Employer reserves the right to accept or reject any or all the bids and to annul the entire process of bidding at any time. Under such circumstances, the Employer will neither be under any obligation to inform the bidders of the grounds for the action of the Employer nor the Employer will be responsible for any liability incurred by the bidder on this account.

LETTER OF NEGOTIATION

In pursuance of negotiation with the Executive Engineer/Superintending Engineer/Chief Engineer of Division/Circle/Region on

I/We agree to reduce the rates for the items in the BoQ as follows.

| Sl.No. | Item No. In the BoQ | Reduced rate/unit |
|--------|---------------------|-------------------|
|--------|---------------------|-------------------|

Signature of Contractor

ORISSA WATER SUPPLY AND SEWERAGE BOARD

Forwarding Slip to The Lump sum Agreement No.

1. Name of Work :
- Estimate Amount :
- Sanctioned in Original Estimate No. :
- Revised Estimate No. :
2. Name of Contractor and Address :
3. Original or Supplemental :
4. If Supplemental, Original Agreement No. :
5. Approximate value of work :
 to be done under this Agreement :
6. If this is Supplemental, approximate value of
 works to be done under Original
 Agreement :
7. If bids have been called for, is the lowest :
 tender accepted?
 If not reasons to be recorded
8. Has the contractor; signed the divisional :
 copy of TNBP and Its addenda volume
 brought up to date.
9. Is data furnished for all items of works :
 noted in the Schedule
10. Are the rates in Agreement within the :
 estimate rates or schedule of rates whichever
 is less and the Lump sum provision sufficient or
 likely to be exceeded.

II. Additional Information

A. Original Agreement

1. Original Agreement amount of tender excess: and percentage over the estimate rate.
2. If concessional rate of EMD & SD have :
been allowed ref. to sanction thereof

B. Supplemental Agreement

1. Whether the approval of the competent :
authority has been obtained for the rates as
required.
2. If entrusted without tenders whether sanction:
is necessary with reference to total value of
work covered by the supplemental agreement
so far accepted.

ORISSA WATER SUPPLY AND SEWERAGE BOARD

Form of Agreement (Lump sum)

Articles of Agreement made this-----

Day of -----

between M/s-----

hereinafter referred to as the contractor which expression shall where the context so admits include his heirs, executors, administrators and legal representatives of the one part and the Orissa Water Supply and Sewerage Board (hereinafter called the Employer) which expression shall where the context so admits include its successors in office and assigns) of the other part. Whereas the contractor delivered to the Employer the bid which was opened on -----

-----whereby the contractor offered and undertook to carry out the works specified under this contract and allied work, i.e. (name of work) -----

In the State of Odisha in India, and provide the works, materials matters and things described or mentioned in these presents at the prices set forth in the schedule annexed to such bid and the contractor also undertook to do all extra and varied works which might be ordered as part of the contract on the terms provided for in the conditions and specifications hereto annexed and the Employer accepted such tender in pursuance where of the parties hereto have entered into this contract.

And whereas the contractor in accordance with the terms of the said Bid has deposited in the Office of the Project Engineer, OWSSB ----- as performance security for the due and faithful performance by the contractor of this contract, the sum of Rs. ----- (Rupees -----)

And whereas the contractor fully understands that on receipt of communication of acceptance of bid from the accepting authority, there emerges a valid contract between the contractor and the Employer represented by the Officer accepting the agreement and the bid documents, i.e. invitation for bids, letter of application, bill of quantities and other schedules, general conditions of the contract, technical specifications of the bid, negotiation letter, communications of acceptance of bid, shall constitute the contract for this purpose and be the foundation off rights of both the parties, as defined in clause 8.1 of ""Bid Documents ""Now hereby agreed that in consideration of payment of the said sum of Rs. (Rupees) or such other sum as may be arrived at under the clause of the General conditions of the contract relating to payment by final measurement at unit prices, the contractor shall and well within the time specified in his bid thoroughly and efficiently and in a good workman like manner perform, provide, execute and do all the works, materials matters of things incidental to or necessary for the entire completion of the works specified under this contract and necessary works

including all works shown in the drawings hereinafter referred to or described or set forth the said specifications and schedule hereto annexed and in accordance with such further drawings and instructions as the Engineer of the Board or other Engineer duly authorised in that behalf (therein after) and in the annexed documents referred to as the Engineer) shall at any time in accordance with the said schedule (Bill of Quantities) and specifications provide and give together, with any alterations in the works or additions thereto, in the time and manner in such schedule (Bill of Quantities) and specifications stipulated to the entire satisfaction of the Engineer, the Employer for themselves and their successors convenient and agree with the Contractor that during the progress of the works and on the completion of contract to the satisfaction of the Engineer, the Employer shall and will from time to time on receiving the certificates in writing of the Engineer pay to the contractor according to such certificates and the terms of this contract the price or sum mentioned in such certificates as due to the contractor under the terms of this contract subject nevertheless to deductions or additions thereto or there from which may be lawfully made under terms of his contract. It is hereby mutually agreed and declared as follows.

- a) All certificates or notice or orders for items or for extra varied or altered works which are to be the subject of an extra or varied or altered works charge shall be in writing whether so described in the contract or not and unless in writing shall not be valid or binding or be of any effect whatsoever.
- b) The term contract includes these presents and the invitation for bid, bid documents, bill of quantities and other schedules, general conditions and specifications hereto annexed and the plans drawings herein and hereafter referred to.
- c) If the contractor claims that the decisions or the instructions of the Employer are unjustified and that accordingly, he is entitled to extra payments on account thereof he shall forthwith notify this to the Employer to record his decisions and reasons there for in writing and shall within two weeks state his claims in writing to the Employer thereafter. The Employer shall thereafter within four weeks of the receipt of the claim, reply to the points raised in the claim. Unless resolved by negotiation or discussions immediate thereafter, within further four weeks the question of liability for such payment will be treated as a dispute.
- d) In the contract whenever, there is as discretion or exercise of will, by the Employer during the progress of the work, the mode or manner of the exercise of discretion shall not be a matter for dispute.
- e) The decision of the Employer shall be final conclusive and binding on all, Parties to the Contract upon all questions relating to the meaning of specifications, designs, drawings and instructions, and as to the quality of workmanship or material used on the work or any matter arising out of or relating to the specifications, designs and drawings and instructions concerning the works or the erection of or failure to execute the same arising during the course of works. The above shall not be the subject matter of dispute and in no case shall the work be stopped consequent on such a dispute arising and the work shall also be carried out by the contractor strictly in accordance with the instructions of the Employer.
- f) In case any question, difference or dispute shall arise on, matters other than clauses (d) and (e) above and except any of the "excluded matters" mentioned in bid documents

touching the construction of any clause herein contained on the rights, duties and liabilities of the parties hereto or any other way touching or arising out of these presents, the same shall.

- i) In the event of any dispute arising between parties here to in respect of any of the matter comprised in this contract, the same shall be settled by a competent court having jurisdiction over the place where contract is awarded and agreement is concluded and by no other court.
- ii) Provided always the contractor shall not except with the consent in writing of the Engineer in any way, delay carrying out works in any such matter, question or dispute being referred to court but shall proceed with the works with all the diligence and shall until the decision of the Employer and no award of Competent Civil Court shall relieve the contractor of his obligations to adhere strictly to the instructions of the Engineer with regard to the actual carrying out of the works.
- g) Time shall be considered as essence of the contract and the contractor hereby agree to commence the work immediately after taking over of site or signing the agreement whichever happens earlier, complete the work within -----months and to show progress at the stipulated milestone.

In witness where of the contractor and the Employer on behalf of the Board have caused their common seal to be affixed the day and year first above written Signed, sealed and delivered by the said.

Signature of Contractor Signed by on behalf of

OWSSB.

Name and Seal.

Signature, Name and Designation of Witness Designation of Witness.

Signed, Name and

INDEMNITY BOND

This deed of indemnity bond executed at (place) on this Day of (month)year by and between M/s / Sri. (Name)

widow/Wife/Son/Daughter of Sri / Smt residing at (Full Address) (hereinafter called "Contractor" which expression unless excluded by or repugnant to the context include his/her heirs, executors administrators and legal representatives) to and in favour of OWSSB (hereinafter called" the Engineer, which expression shall unless excluded by or repugnant to the context include its successor and assigns) represented by the Project Director of Circle / Project Engineer of PMU shown as follows;

2. Whereas the contractor has submitted the bid for Septage treatment Plant in Bhubaneswar City in Khordha District - Septage Treatment Plant in Bhubaneswar City in Khordha District, Odisha - Construction of Settling-thickening tanks, Sludge drying beds, Anaerobic Baffled Reactors, Horizontal planted gravel filter, Maturation pond, Filtrate sump, Security room, CC pavement, construction of compound wall around the treatment plant, Effluent disposal arrangement, Construction of Pump Room of 12 m², supply, delivery and installation of Non clog submersible pump sets, laboratory room, watch shed, administrative room etc. complete including Trial run for 3 Months (period of completion - 9 months) and such bid has been accepted subject to the relevant conditions to contract appended to Odisha Building Practice and other conditions issued along with bid documents.

3. And where as in pursuance of the terms of contract, that a sum equal to **two and half** % of the total value of work done have been retained with the Employer for a period of two years reckoned from the date of completion of the work in order to enable the departmental officers to watch the effect of all seasons on the work and the structural stability of the work executed by the contractor.

4. And whereas it was decided to refund the said sum equal to **two and half** % of the total value of the work done retained with the Employer on the expiry of two years period reckoned from the date of completion of work provided that the contractor execute an indemnity bond for a period of three years indemnifying the Board against any loss or expenditure incurred to rectify any defect noticed due to the faulty workmanship by the contractor or substandard material used by the contractor during the period of three years.

5. Now this deed of indemnity witness that in consideration of the contract entrusted to the contract or by the Employer, the contractor has agreed to the following terms and conditions and executed this indemnity bond in conformation of all and undertakes to comply with the terms referred to infra.

6. The contractor both hereby indemnify the Employer against any loss or damage that may be caused to the Employer in respect of rectification of any defect noticed due to the faulty workmanship by the contractor, or substandard material so used by other contractor in the execution of work entrusted to the contractor during the period of three years i.e. from up to (dates to be specified)

7. It is hereby confirmed that in all other respects, the agreement conditions will be binding between the parties.

In witness whereof Sri / Smt / Ms

Contractor has signed this deed on this day of month year.

Witness:

INDEMNITY BOND

(In lieu of water tightness and structural stability)

To accompany the Lump sum agreement No.

This deed of Indemnity made this day of _____ between
Sri _____ S/o _____ (hereinafter called
contractor "which expression shall unless excluded by or repugnant to the context include his heir/executors, administrators and legal representatives) and in favour of the Orissa Water Supply and Sewerage Board (hereinafter called the Employer which expression shall unless excluded by or repugnant to the context include its successors and assigns) represented by the Project Director, OWSSB / Project Engineer, PMU, OWSSB, Cuttack as follows;

Whereas the contractor agreed to construct a reinforced cement concrete Water Retaining Structures including pipe connections as per departmental plan and designs under SeTP Project Rs. (Rupees) as per Lump Sum Agreement No./ and two of the conditions of the said agreement are;

1. That the contractor should reduce a water tight structure and guarantee its water tightness for two years as per clause in Form in General conditions of contract, definitions and interpretations.

2. That in lieu of the 40% (Forty percent) of the amount of each bills scheduled to be withheld from the payment and kept with the Employer with security deposit till the expiry of the above guarantee period and till a certificate of soundness of structure is furnished by **the Project Engineer, PMU, No-II, Bhubaneswar, OWSSB** the contractor has agreed to execute an Indemnity bond vide clauses in Form in General conditions of contract, definitions and interpretations of Lump Sum Agreement No.

And whereas the Employer has agreed to accept a deed of Indemnity from the contractor in lieu of 40% (Forty percent) of the amount of each bill to be withheld from payment.

Now these present witness that in pursuance of the above said agreement and for the consideration above said, the contractor hereby agrees with the Employer that he will at all times indemnify and keep harmless of the Employer as a result of the failure of the contractor to remedy or to replace any failure or defects in the water tight structure for a period of two years from the date of commissioning which includes maintenance period of one year.

The contractor further agree with the Employer that on receipt of the report of the Engineer in charge about any failure or defects noticed in the structure within a period of two years from the actual date of commissioning and handing over to the Employer after Trial run period .A joint inspection has to be made immediately by the Engineer of the contractor and the Engineer in charge of SeTP in Bhubaneswar City and if in the opinion of the **Project Engineer, PMU, No-II, Bhubaneswar, OWSSB** the failure or defects noticed are due to the defects in the structure (construction) the contractor undertakes to rectify or replace immediately the structure at contractor's cost and the contractor agrees to extend the guarantee period for two more years from the date of rectification of the defects.

The contractor further agrees with the Employer that in the case of any dispute arising between the contractors on one hand and the Project Engineer, PMU, No-II, Bhubaneswar, OWSSB on the other hand as to any matter relating to the defects or failure noticed in the structure and the contractor's guarantee for water tightness for a period of two years from the accepted date of completion of the structure as indicated above such dispute shall be referred to the Member Secretary, OWSSB, Satyanagar, Bhubaneswar, whose decision shall be final. In witness whereof Sri

..... S/o
District and the Project Director / Project Engineer, PMU, No-II, Bhubaneswar, OWSSB acting on behalf of OWSSB have hereunto set their hands on the day and the year first written above.

Signature Signature
Name: Name:
Seal: Seal

PERFORMANCE BANK GUARANTEE (UNCONDITIONAL)

To
The Project Engineer,
PM Unit, Cuttack

----- (Name of Employer) -----
----- (Address of Employer)

WHEREAS ----- (name and address of contractor) (hereinafter called" the contractor" has undertaken, in pursuance of contract No.-----

--- Dated ----- to execute----- (name of contract and brief description of works) hereinafter called " the contract**"

AND WHEREAS it has been stipulated by you in the said contract that the contractor shall furnish you with a Bank Guarantee by a recognised bank for the sum specified therein, as security for compliance with his obligations in accordance with the contract.

AND WHEREAS the contractor has requested us to give the Bank Guarantee

AND WHEREAS we have agreed to give the contractor such a Bank Guarantee unconditionally and irrevocably to guarantee as primary obligator and not as mere surety, all the payments to the -----

NOW THEREFORE we hereby affirm that we are the Guarantor and responsible to you, on behalf of the contractor, up to a total of ----- (amount of Guarantee) -----
----- (amount in words such sum being payable in the types and proportion of currencies in Which the contract price is payable, and we undertake to pay you unconditionally and Irrevocably upon your first written demand and without cavil or argument, any sum or Sums within the limit of -----

----- (amount of Guarantee) as aforesaid Without you needing to prove or to show grounds or reasons for your demand for the Sum specified therein.

We hereby waive the necessity of your demanding the said debt from the contractor before presenting us with the demand.

We further agree that no change or addition to or other modification of the terms of the contractor or of the Works to be performed there under or of any of the contract documents which may be made between you and the contractor shall in any way release as from the liability under this guarantee and we hereby waive notice of any such change, addition or modification.

The Bank Guarantee is drawn at _____branch of _____bank in _____City in Odisha only.

This guarantee shall be valid until 28 days from the date of expiry of the defects liability period.

SIGNATURE AND SEAL OF THE GUARANTOR

Name of Bank _____

Address _____

Date _____

BID SECURITY (BANK GUARANTEE)

WHEREAS, _____ *[name of Bidder]* (hereinafter called "the Bidder") has submitted his Bid dated _____ *[date]* for the construction of _____ *[name of Contract]* (hereinafter called "the Bid").

KNOW ALL PEOPLE by these presents that We _____ *[name of bank]* of _____ having our registered office at _____ (hereinafter called "the Bank") are bound unto _____ *[name of Employer]* (hereinafter called "the Employer") in the sum of _____¹ for which payment well and truly to be made to the said Employer the Bank binds itself, his successors and assigns by these presents.

SEALED with the Common Seal of the said Bank this _____ day of _____ **2016**.

THE CONDITIONS of this obligation are:

- 1) If after Bid opening the Bidder withdraws his bid during the period of Bid validity specified in the Form of Bid;

or
- 2) If the Bidder having been notified of the acceptance of his bid by the Employer during the period of Bid validity:
 - (a) fails or refuses to execute the Form of Agreement in accordance with the Instructions to Bidders, if required; or
 - (b) fails or refuses to furnish the Performance Security, in accordance with the Instruction to Bidders; or
 - (c) does not accept the correction of the Bid Price pursuant to Clause 28.2;

we undertake to pay to the Employer up to the above amount upon receipt of his first written demand, without the Employer having to substantiate his demand, provided that in his demand the Employer will note that the amount claimed by him is due to him owing to the occurrence of one or any of the three conditions, specifying the occurred condition or conditions.

This Guarantee will remain in force up to and including the date _____² days after the deadline for submission of Bids as such deadline is stated in the Instructions to Bidders or as it may be extended by the Employer, notice of which extension(s) to the Bank is hereby waived. Any demand in respect of this guarantee should reach the Bank not later than the above date.

DATE _____ SIGNATURE OF THE BANK

WITNESS _____ SEAL _____

[signature, name, and address]

- 1 The Bidder should insert the amount of the guarantee in words and figures denominated in Indian Rupees. This figure should be the same as shown in Clause 16.1 of the Instructions to Bidders.
- 2 45 days after the end of the validity period of the Bid.



Orissa Water Supply and Sewerage Board

Name of work:-

Construction of Septage Treatment Plant in Bhubaneswar City in Khordha District, Odisha - Construction of Settling-thickening tanks, Sludge drying beds, Anaerobic Baffled Reactors, Horizontal planted gravel filter, Maturation pond, Filtrate sump, Security room, CC pavement, construction of compound wall around the treatment plant, Effluent disposal arrangement, Construction of Pump Room, supply, delivery and installation of Non clog submersible pump sets, laboratory room, watch shed, administrative room etc. complete including Trial run for 3 Months (period of completion - 9 months)

TECHNICAL SPECIFICATIONS

Last date of submission: Up to 17.00 hrs on 2016

Technical Specifications

Index

| Sl. No. | Description |
|---------|--|
| I | SCOPE OF WORK |
| II | GENERAL SPECIFICATION |
| III | GENERAL SPECIFICATION FOR MATERIALS |
| IV | CIVIL WORKS |
| V | SPECIALS SPECIFICATIONS FOR SEWERAGE SYSTEM |
| VI | PIPE LAYING WORKS. |
| VII | LIQUID RETAINING STRUCTURES |
| VIII | ELECTRICAL WORKS AND PUMPING MACHINERY |
| | A. ELECTRICAL |
| | B. PUMPSETS AND ACCESSORIES |
| | C.PUMPSETS AND ACCESSORIES (Non-Clog) |
| IX | ANNEXURES |
| X | SEPTAGE TREATMENT PLANT |
| XI | TESTING, ERECTION, TRIAL RUN, COMMISSIONING AND ACCEPTANCE |
| XII | MINIMUM ENVIRONMENTAL MANAGEMENT MEASURES |
| XIII | TRIAL RUN OF PROJECT |
| XIV | REFERENCE FOR SPECIFICATION / CODE OF PRACTICE |

I. **SCOPE OF WORK**

1. Introduction

Bhubaneswar, the capital city of the State is well connected by rail, air and road (NH 5). Bhubaneswar is the business & tourism gateway of the state. The city has become one of the major IT hub of India. It houses all the major corporate offices of India. There is a rail coach manufacturing unit. The city has great potential in the areas of IT & BPM, railways, tourism and hospitality. Adequate land is available for horizontal growth of the city and to accommodate future infrastructure needs with low environmental risk. There is adequate source for water and availability of potable water supply in Bhubaneswar to match the national benchmark. Existing Sewerage system is in place which is being augmented under JnNURM & JAICA funding. The storm water drainage system is also being developed under JnNURM. Solid waste of the city is managed on PPP mode including landfill and treatment.

2. Necessity of the Scheme

Odisha is one of the least urbanized state in India. The rate of urbanization considering the growth trend since 1941 the rate is quite low and in the last decade it was almost half of the national average i.e. 16.68% against 31.16%.

Most of the ULBs are of the nature that these local bodies do not have the capacity to create and manage assets for treatment of liquid waste as these involve large investment and long gestation periods. Further, as per Census 2011, 49% of the urban population in Odisha continues to dispose waste into **septic tanks, many of which are not designed properly**, and hence sewage does not get treated effectively resulting in fecal contamination. Septage generated from septic tanks therefore requires focused and immediate attention to improve the sanitation situation in the State.

Atal Mission of Rejuvenation & Urban Transformation (AMRUT) was launched by the Ministry of Urban Development, Govt. of India on 25th June 2015 for next 5 Years i.e. up to March 2020. Five hundred (500) cities are taken up under the Mission having a population greater than one lakh (100,000). Under the mission MoUD, GoI will provide 50% of project fund while State & ULB will share rest 50%. Under the programme nine towns of Odisha have been identified for intervention. They are, Bhubaneswar, Puri, Cuttack, Berhampur, Sambalpur, Bhadrak, Balasore, Baripada and Rourkela.

Though the integrated sewerage project for Bhubaneswar is currently being executed, it will take another three to four years for optimal operation of the sewerage system. Moreover, since the city has a tendency of higher growth rate, the city will continue to grow in horizontal direction due to availability of vacant land and therefore it may not be possible to provide conventional sewerage system to all the dwelling areas and therefore, a certain percentage of the population shall always have to depend on on-site systems like septic tanks, leach pits etc. These systems will require a septage management policy to be in place and shall have to be managed accordingly. Though

currently under AMRUT action has been taken to build and operate one septage unit in Bhubaneswar, it is likely that a number of systems may have to be built in due course of time to provide appropriate treatment to the on-site system. This may be funded through AMRUT or through some other source of funding in a phased manner based on ground assessment.

The Septage treatment technology to be adopted has been selected based on the guidance provided in the Ministry's Guidance Note on Septage Management and taking cognizance of the fact that as mentioned in the Guidance Note, the choice of an appropriate Septage management system is dependent on land availability, hauling distance, technical requirements, and availability of skilled labour, legal and regulatory requirements. The suitability of different options is discussed below:

Choice of Treatment Technology:

Based on the guidance and local circumstances, sludge drying beds have been chosen for Septage dewatering. The filtrate from the sludge drying beds will be treated in DEWATS chain. The filtrate from the horizontal Planted Gravel Filter will be treated in maturation pond for tertiary treatment. The treated effluent conforming to OPCB requirement shall either be used for irrigation in public parks after disinfection, or in horticulture or for HRTS or else can be discharged to inland water bodies. Reuse shall be prioritized over disposal.

3. Approval

The State Government has administratively approved the project in State Level Technical Committee (SLTC) for Septage management to Bhubaneswar for the year 2015-16. The cost of project is estimated at Rs. 2.83 crore under AMRUT fund. OWSSB has prepared the Detailed Project Report on Septage Management Project for Bhubaneswar City for Rs.377.38 Lakhs (including 5 years O&M).

4. Detailed Description of the proposal

The Septage collected from the septic tank will be transported to the proposed Treatment site. Based on the guidance and local circumstances, sludge drying beds have been chosen for Septage dewatering. The concept of the functional design has been in accordance with the Detailed Project Report forwarded by the Directorate of Town panchayat for implementation. Since the above project is first of its kind and on the experimental basis the treated BOD expected is 10mg/l as per OPCB norms.

The components of proposed treatment plant are as detailed below

1. Screen Channel: (2 nos.)

One sludge receiving chamber of 1.50 m x 1.50 m clear size will be provided
0.6 m (0.3 m SWD) x 3.0 m
Bar screen 1 m wide x 1 m depth – MOC: SS 316
Angle of placement to horizontal 45°, placed on a support channel for easy maintenance.
Feeder channel and bar screen shall be built above ground.
Unloading height shall be between 2 to 3 meters above ground.
Channel to be supported on short columns
Material of construction: R.C.C (M25)

2. Settler-cum-thickener: (2 nos.)

L x B x D = 14.5 m x 2.5 m x 2.55 m (depth at outlet including FB)
Bottom slope 2% reverse.
Pump / sludge pit size 1000 mm x 1000 mm
Material of construction: R.C.C (M25)
Construction is over ground provided the level permits.
Baffles to be placed at 1 m from both ends across the width for flow and scum control.
Emptying period is once every 10 days.
Emptying to be carried out through pump to the SDBs.
All piping shall not be less than 150 mm ϕ
Supernatant shall be withdrawn through gravity to the ABRs
Twin settlers to be provided with common header channel
Lime addition can be done in the header channel, if required.
A walking platform 1000 mm wide to be built all around the settler for maintenance.

3. Unplanted Drying Beds: (10 nos.)

Size: 5000 mm x 15000 mm
Nos: 10 numbers of bed to be provided.
Material of construction of walls: R.C.C (M25)
Material of construction of floors: Fly-ash bricks on edge
Underdrains dimension: 150 mm, brick on edge
Laterals: 75 mm channels placed @ 1 m intervals.
Bed slope of 1% towards the underdrain.
Size of piping up to the leachate sump: 150 mm
Depth of sand bed: 150 mm
Size of sand: 0.5 to 1 mm with UC not more than 4
Depth of gravel bed: 300 mm
Size of gravel: 20-40 mm in bottom half and 5 to 15 mm on top half
Sloped part may be covered with perforated slabs on which the gravels can be placed.
Size of perforated slabs: 1000 mm x 1000 mm x 100 mm
Size of perforation: 20-25 mm

Splash plate of 0.6 m x 1.0 m to be provided on the sand bed at the pipe discharge point.
MOC of splash plate: SS 304 with a minimum thickness of 6 mm to be fixed to the walls through brackets which can be removed during maintenance. The clearance of splash plates from the sand bed shall be 25 mm.

All piping to the SDB shall be 100 mm size and of HDPE material.

All valves shall be of DI make.

The beds are of twin type with central feeder pipes.

4. Anaerobic Baffled Reactors: (2 nos.)

Dimension: 13000 mm x 5000 mm x 2000 mm (1750 mm SWD)

Settler size: 5000 mm x 5000 mm

Up-flow reactor chamber size: 1175 mm x 5000 mm x 1750 mm SWD

Shaft width: 300 mm

MOC: R.C.C (M25), all piping HDPE of 150mm size.

To be built under ground with roof above ground level.

Number of reactor compartments = 5

Size of manhole: 600 mm x 600 mm, all reactors compartments shall have manholes for sludge removal.

Twin tanks of above size with common central wall shall be provided.

Adequate ventilation through piping shall be provided.

The ABRs shall be fed through gravity from the thickener tanks through piping of size not less than 150 mm with provision of DI valves. All piping inside ABR shall be of HDPE type. Details provided in the literature shall be followed while construction. Two extra cells within the ABR may be added for anaerobic filtration.

5. Planted Gravel Filters (Horizontal) (1 no)

Area: 1750 m² (50 m x 35 m)

Slope: 1%, depth at entrance: 0.6 m

COD and BOD₅ out flow: **15 and 9.5** respectively.

40 m wide channel with 50 mm opening shall be used across the width for even distribution of flow to the wetland.

Start depth of 0.6 m and end depth of 0.9 m shall be provided.

Bottom of the wetland may be made of brick flooring with brick on edge.

Washed gravel of size 5 mm – 30 mm shall be provided on the bed.

Water level at 150 mm below the surface shall be maintained.

Phragmites australis (reed) is a common choice to be planted since it forms horizontal rhizomes that penetrate the entire filter depth

The effluent shall be used for irrigation of parks etc.

6. Polishing Pond: (1 no)

Pond area = 70 m², size: 7 m x 10 m

Pond depth = 1.0 m

Brick lining with cement plaster may be provided on the bank for slope protection.

A pump shall be installed for collection of effluent and for further disposal.

7. One leachate sump of 3.0 m dia and 3.00 m deep of RCC with top cover may be provided along with pumping arrangement for feeding to the ABR.

8. Other Ancillary Units:

1. Space for co-composting: a minimum of 200 m² shall be provided
2. Guard room of 10 m² size shall be provided.
3. One production well and one overhead tank of 5000 litres capacity shall be provided.
4. One room 4 m x 6 m size for laboratory equipment purpose shall be provided.
5. One equipment room along with administrative room of size 4 m x 10 m shall be provided for administrative purpose.
6. Since only panels are installed (in case of submersibles), the total pump room area for leachate, sludge and final effluent may be restricted to 12 m².
7. One electrical sub-station of appropriate size.
8. One compound wall around the SeTP.
9. CC Roads and storm drains for the SeTP area.

Note: For Detailed requirement, the approved DPR should be referred to.

II. GENERAL SPECIFICATIONS

1. Contractor's Responsibility

The information given hereunder and provided elsewhere is given in good faith but the Contractor shall satisfy himself regarding all aspects of site conditions and no claim whatsoever will be entertained on the plea that information supplied by the Engineers is erroneous or insufficient.

2. Construction Water

The Contractor shall make his own arrangement for the fresh water required for the manufacturing of the pipes, construction of civil works and testing of pipeline as well as for the potable water required for his factory & labour camps.

3. Construction Power

The Contractor shall make his own arrangement for supply of electrical energy required at his sites and the works from the CESU.

The Contractor is forewarned that there can be interruptions in power supply for reasons beyond the control of the CESU and therefore, the Contractor is advised to make his standby arrangement to provide and maintain all essential power supply for his work area at his expense. The Contractor shall not be entitled to any compensation for any loss or damage to his machinery or any equipment or any consequential loss in progress of work and idle labour.

4. Survey

The Contractor shall, at his own expense provide and maintain survey stations which he may be required to carry out the works and shall remove the same on completion of the works. The Contractor shall, at his own expense, carry out all the necessary surveys, measurements and setting out of the works and shall for this purpose engage qualified and competent engineering surveyors whose names and qualifications shall be submitted to the Engineer for his approval.

The Contractor shall for the purpose of checking the survey and setting out, provide to the Engineer all the assistance, which he may require. The surveyor shall be selected having appropriate experience and as far as possible, the same surveyor shall be provided throughout the contract period. Before commencing any work at any locations, the Contractor shall give the Engineer not less than two days' notice of his intention to set out or give levels for any part of the work in order that arrangements may be made for inspection. The Contractor shall provide for the sole use of the Engineer and his staff, all necessary survey instruments and other equipment and all technicians, labour and attendants which the Engineer may require for checking the setting out and marking of the works. The Contractor shall maintain in good working order at all time during the period of contract the instruments provided by him, for the proper setting out of the works. The Contractor shall make available at his own expense, any poles, staging templates.

5. Temporary Fencing

The Contractor shall, at his own expense, erect and maintain in good condition temporary fences and gates along the boundaries of the areas assigned, if any, to him by the Employer for the purpose of the execution of the works.

The Contractor shall, except when authorized by the Engineer, confine his men, materials and plant within the site of which he is given possession. The Contractor shall not use any part of the site for purposes not connected with the works unless prior written consent of the Engineer has been obtained. Access shall be made to such areas only by way of approved gateways.

6. Return of Labour and Plant

The Contractor shall supply to the Engineer by 10 a.m. every working day a return of the men employed by him and his sub-contractors on the previous working day and all of the work on which they were engaged specifying also the number employed in each trade. He shall also supply monthly any other returns which may be required as to the number of men and constructional plant employed and the nature and type of the work done.

7. Sanitary Facilities

The Contractor shall provide and maintain in a clean and sanitary condition adequate W.Cs and wash places which may be required on the various parts of the site for use of his employees, to the satisfaction of the Engineer. The Contractor shall make all arrangements for the disposal of sewage or drainage in accordance with the directions of the Engineer.

8. Restricted Entry to Site

The Contractor shall get the prior permission of the Engineer before any person not directly connected with the works to visit the site.

9. Existing Services

Drains, pipes, cables, overhead electric wires and similar services encountered in the course of the works shall be guarded from injury by the Contractor at his own cost, so that they may continue in full and uninterrupted use to the satisfaction of the Employer and the Contractor shall not store materials or otherwise occupy any part of the site in a manner likely to hinder the operation of such services. Should any damage be done by the Contractor on any mains, pipes, cables or lines (whether above or below ground), whether or not shown on the drawings, the Contractor must make good or bear the cost of making good the same without delay to the satisfaction of the Engineer and of the Employer.

10. Local Roads and Haul Roads

The approach roads and other public roads in the state may be used by the Contractor to haul construction materials and equipment subject to restriction of load carrying capacity on the roads in particular over bridges and culverts. However, the Contractor will have to pay customary vehicles license and permit fees for use of public roads.

The Contractor shall plan transportation of construction materials to site in such a way that road accidents are avoided.

11. Permission for Road Cuts

Wherever the Contractor considers that it is necessary to cut through an existing road or track he shall submit details to the Engineer for approval, a minimum of seven days before such work commence.

In the event of cutting a road by the Contractor without permission from the Engineer the Contractor shall pay compensation as claimed by the owner of the road until it is restored at the cost of the erring Contractor.

Trench Digging:

Digging of trench by the Contractor beyond the length than that is specified by the Engineer **shall invite a fine of Rs.500/- per day** till such time the damage is restored.

12. Temporary Diversion of Roads

During the execution of the works the Contractor shall make at his cost all necessary provision for the temporary diversion of roads, cart-tracks, footpaths, drains, water courses, channels etc., Should he fail to do so, the same shall be done by the Engineer and the cost thereof will be recovered from the Contractor.

13. Notice to Telephone, Railways & Electricity Supply under Takings / Depts., etc.

The Employer shall deposit an amount to the respective local bodies/Highways department for restoration of road surface after completion of pipe laying work. The Employer shall obtain general permission to cut the road.

Before commencing operation, the Contractor has to obtain specific permission from local bodies/Highways Department when he wants to cut any section of the road. Where operations involve cutting of roads, shifting utilities etc. during the process of work, the Contractor shall also give notice to the concerned authorities viz. the panchayats /the Municipalities, the Railway department, the Electricity Board, Telegraphs department, the Traffic department attached to the police and other departments or companies as may be affected by the work. The notice should identify the specific details so that the necessary diversion of traffic may be arranged and permissions obtained. The Contractor shall co-operate with the department concerned and provide for necessary barricading of roads, protection to existing underground cables etc. met with during the excavation of trenches. The Contractor shall provide at his own expenses watching and lighting arrangements during day and night and erect required notice board such as "Caution Road closed for Traffic" etc. He should also provide and maintain at his own cost the necessary supports for underground cables etc. to afford best protection to them in consultation with the authorities in-charge of the properties and to their best satisfaction. The Contractor has to make necessary arrangements to get supply of electricity from CESU for operating the machinery and equipment. The Employer will pay the necessary service connection and S.D. charges. The Contractor should obtain all approvals for the installation and commissioning of machinery and accessories offered by them from the respective inspecting authorities, fees if any, to be paid to the inspecting authorities will be reimbursed by the Employer.

14. Barricading

The pit / trench shall be barricaded on all four sides. The Contractor who has dug up the trench shall be responsible for any mishap, which may occur. Non-barricading of trenches by the Contractor **shall be liable for a fine of Rs.500/- per day.**

15. Length of Trench Open at One Time

The Pipe line shall be excavated in such length as may be ordered by the Engineer depending on the nature of the ground, the depth from the surface and the risk of damage to the adjoining property. The pipes shall not be covered until they may have been tested to the satisfaction of the Engineer. But in bad ground in close proximity to buildings or in other places where the Engineer shall consider necessary he may limit the length of trench so that there shall not be more than three pipes lengths from the refilled trench to the unbroken ground ahead.

16. Watching and Lighting

The Contractor shall at his expense provide at the site of work sufficient lighting and watching and fencing by night and by day and shall in every respect conform to the police regulations in these matters and he shall free and relieve the Employer, should he neglect to do so, the same shall be provided by the Engineer and the cost thereof will be recovered from the Contractor.

17. Filling in Holes and Trenches Etc.

The Contractor immediately upon completion of the Works shall fill up holes and trenches which may have been made or dug, level the mounds, or heaps of earth that may have been raised or made, and clear away all rubbish which may have become superfluous or have been occasioned or made in the execution of the works, and the Contractor shall bear and pay all costs, charges etc. Failure to carry out the work within two days **will attract a fine of Rs 500/- per day.**

18. Power to Vary Work

The Engineer reserves the power to vary, extend or diminish the quantities of Work, to alter the line, level, or position of any work to increase, change or decrease the size, quantity, description, character or kind of any Work, to order the Contractor to execute the Works or any part thereof, by day or night Work, or to add or to take from the Work included in the contract as he may think proper without violating the contract and the Contractor shall not have any claim upon the Employer for any such variation, extension, diminution, alteration, increase, change or decrease other than for the Work actually done, calculated according to the prices tendered and accepted in this contract.

19. Extra for Varied Work

If the Engineer uses the power reserved to him under Clause 18 above an order in writing signed by the Engineer, shall be given to the Contractor to that effect and any Work executed under such order shall be paid for at the rates set forth in the Schedule of Rates prevailing at the time of execution where such rates in the opinion of the Engineer apply. This shall apply to unforeseen items of work which are not found in the Bill of Quantities. If the rates are not available in the Schedule of Prices, a rate or price shall be agreed upon between the Engineer and the Contractor in writing and failing their agreement the Contractor shall forthwith execute such order and the Engineer shall determine the rates or prices at which the work shall be paid off.

20. Free Flow of traffic

While executing the work, as soon as possible, the Contractor should allow as much traffic as possible on the roads / streets, by refilling the trenches cut across.

21. Tools and Plants

All tools and plants required for the work including sheet piles and timber for shoring and strutting, pump sets etc. shall be supplied by the Contractor at his own cost. The rate for the relevant items of work are inclusive of all such tools and plants and apparatus required for the execution of the work.

22. Excess Materials

The Contractor shall be responsible for the procurement of required quantity of materials like pipes, specials, machinery, electrical items etc. Any materials procured for the work, if found excess due to any reasons after completion of the works, shall be taken back by the Contractor and the Employer / Engineer shall not be responsible for such excess materials. Amount paid if any for such excess materials shall be deducted from any bills payable to the Contractor.

23. Commissioning of Works

The Contractor shall be responsible for successful commissioning of the scheme and maintenance period of one year.

24. General

Before submitting the bids, the bidder should carefully go through all the bid documents, drawings and also inspect the place of work so as to get full and firsthand knowledge of the site conditions based on which he has to quote his rate.

24.1 Accidents

It shall be the duty of the Contractor to arrange for the execution of the works in such a manner as to avoid the possibility of the accidents to persons or damage to the properties at any stage of the progress of work. Nevertheless, he shall be held wholly responsible for any injury or damage to persons and properties, which may occur irrespective of any precautions he may take during the execution of the works. The Contractor shall make good all claims and loss arising out of such accidents and indemnify the Employer from all such claims and expenses on account thereof.

24.2 Flood Damages etc.

The Contractor has to take risk insurance at his cost against losses due to unprecedented floods and other acts of God. No claim shall be entertained on this account and paid for.

24.3 Water and Lighting

The Contractor shall pay all fees and provide water and light as required from Municipal mains or other sources and shall pay all charges therefor (including storage tanks, meters etc.) for the use of the works and workmen, unless otherwise arranged and decided on by writing with Engineer. The water used for the works shall be free from earthy vegetable or organic matter and from salts or other substances likely to interfere with the setting of mortar or otherwise prove harmful to the work and conform to relevant standards.

24.4. Rates

The Contractor shall particularly note that the accepted rates of the various items shall be inclusive of all incidental charges such as baling by manual labour, dewatering, shoring etc. if found necessary during the execution and no extra shall be due therefore on any account during the currency of the contract, unless stated otherwise.

24.5. Royalty Charges

The Royalty will be charged for the materials obtained from P.W. Department, or other Government quarries. Assistance as necessary will be given to the Contractor by the Engineer. No plot rent shall be charged for materials stacked on Employer's lands during the course of construction provided all such materials are removed within one month after the work is completed. Royalty or charges due in the case of private quarries and private bodies shall be paid by the Contractor.

24.6. Payment to Labour

The Contractor should note that in the event of emergency, he shall pay all Labourers every day and if this is not done, the Employer shall make requisite payment and recover the cost from the Contractor. The Contractor shall not employ any laborer below the age of 15 years.

24.7 Night Works

If night work is required to fulfill the agreed rate of progress and to complete the work within the period stipulated, prior written approval is necessary and all arrangement shall be made by the Contractor including lighting without any claim for extra rate.

24.8. Errors, Omissions and Discrepancies

In the case of errors, omissions, and/or disagreement between the written and the scaled dimensions on the drawings or between the drawings and the specifications, the following order of precedence shall apply;

- i) In case of discrepancies in dimensions of any item of work as described between the descriptive specifications and detailed working drawings, the dimensions given in the detailed working drawings shall apply.
- ii) In case of discrepancies in description of scope of work between what is indicated in the item of work given in Bill of Quantities and the corresponding detailed technical specifications, the latter shall apply.
- iii) Figured dimensions shall supersede scaled dimensions. The drawings on a large scale shall take precedence over those on a smaller scale.
- iv) Drawing issued as construction drawings from time to time shall supersede the corresponding drawings previously issued.

24.9. Equivalence of Standards and Codes

Whenever reference is made in the contract to the respective standards and codes in accordance with which plant, equipment or materials are to be furnished and work is to be performed or tested the provisions of the latest current edition or revision of the relevant standards and codes in effect shall apply, unless otherwise expressly set forth in the contract. Where such standards and codes are national in character, or relate to a particular country or region, other authoritative standards which ensure equal or higher quality than the standards and codes specified will be accepted subject to the prior review and written approval by the Engineer. Difference between the standards specified and the proposed authoritative standards must be fully described in writing by the Contractor and submitted to the Engineer well in advance for approval. If on the prior review, the Engineer determines that such proposed deviations do not ensure equal or higher quality, the Contractor shall comply with the standards set forth in the contract document.

24.10 Bidder to satisfy Himself

It will be the Contractor's responsibility to satisfy himself from the inspection of the site that sufficient quantities of construction materials required for the works exist in the designated borrow areas and quarry sites.

Failure by the Contractor to have done all the things, which in accordance with this condition he is deemed to have done shall not relieve him of the responsibility for satisfactorily completing the work as required.

24.11 Employment of Scarcity Labour

If Government of Odisha declares a state of scarcity or famine to exist within 16 kMs of the project site, the Contractor shall be required to employ in his works for which he will need unskilled labour and to the extent his works can accommodate any person or persons certified to him by the Engineer to be in need of relief and the Contractor shall pay to such persons wages not below the minimum wage which the Government may fix in this behalf from time to time.

24.12 Workman Compensation Act

All labourers and other employees of the Contractor should be covered by a suitable accident insurance policy to cover liabilities under the Workman's Compensation Act.

24.13 Electricity Tariff

The unit rates and prices quoted by the Bidder in the Bill of Quantities shall include the cost of electric energy required for construction at the rates fixed by CESU.

III. GENERAL SPECIFICATION FOR MATERIALS

All materials required for the works shall be procured and supplied by the contractor himself. The materials shall be of good quality and conforming to relevant BIS. The materials which are classified for ISI marking should be supplied with ISI marking only.

1. Cement and Reinforcement:

1.1 The entire quantity of cement and steel required for the work will be procured by the contractor. The contractor is responsible for all transport and storage of the materials and shall bear all related cost. The Employer shall be entitled at any reasonable time to examine the cement and steel supplied by the contractor.

1.2 The cement procured by the contractor shall comply with the requirements of IS 269/ 1976 with the latest revision thereof for ordinary Portland cement and IS 8112/ 1989 with the latest revision thereof for 43 grade ordinary Portland cement. The Sulfate Resisting Portland Cement procured by the contractor shall comply with the requirements of IS

12330 with the latest revision. It shall be of the best normal setting quality unless special rapid hardening or quick setting quality if expressly instructed by the Engineer to be supplied. Each bag shall bear ISI Certification mark.

1.3 The steel bars shall comply with the requirements set forth in the IS 432 Part I, IS 1139, IS 1786 as the case may be with the latest revision thereof and the test as described for ultimate tensile strength, bond test and elongation tests.

All reinforcing steel shall be clean and free from oil, grease, loose scales or rust or other coatings of any character which would reduce or destroy the bend. Each bundle containing the bars shall bear the ISI Certification mark.

1.4 The cement / steel shall be tested in nearby laboratories of Government / Polytechnic or Engineering College by the Employer. Two samples should be taken by the Engineer in charge in the presence of the contractor or his authorized representatives or the technical personnel employed by the contractor as in the agreement. The contractor shall without extra cost provide samples and cooperate in the testing of the cement/ steel. One sample shall be got tested and the other sample shall be retained by making clear identification in the sample by the Engineer in charge so as to identify at a later date. The cost of such test shall be borne by the contractor.

1.5 All cement shall be procured in bags and shall be stored in a dry place for which the contractor shall be responsible. Consignment of bagged cement shall be properly stacked in a manner which will permit easy access for inspection and definite identification. Cement shall be used in approximately in the chronological order in which it is received, but cement that has been stored for a period longer than 4 months from the date of initial sampling shall not be used unless it has been retested at the expenses of the contractor and passed by the Engineer in charge as good quality on the retest. Cement aged more than 180 days from the date of initial sampling shall be rejected.

1.6 Cement which has become caked or perished shall on no account be used on the works and shall be rejected. Although the Engineer may have passed any consignment, he shall however have the power at the subsequent time to reject such consignment if he finds that any deterioration in the quality thereon has taken place.

1.7 A record of the quantity of cement/ steel procured with the name of dealer, bill number and date shall be maintained by the contractor. This should be produced for examination by the Engineer in charge at any time. The age of the cement shall be reckoned from the date of manufacture and it shall be verified by the Engineer in charge.

1.8 The rejected consignment of cement and steel should be removed from the site within two days.

Bricks:

a. Manufacture:

Common burnt clay building bricks shall conform to the requirements of IS 1077 and shall be of quality not less than class 50 with moisture absorption rate not exceeding 15% as defined in IS : 1077. The bricks shall be chamber burnt and shall not be damaged in any manner and sizes shall conform to the works sizes specified with tolerates as given in 6.2 of IS: 1077.

b. Samples:

The Contractor shall deliver samples of each type of brick to the Engineer, and no orders shall be placed without the written approval of the Engineer. All the bricks used in the works shall be of the same standard as the approved samples. The samples shall be preserved on site, and subsequent deliveries shall be checked for uniformity of shape, colour and texture against the samples. If in the opinion of the Engineer any deliveries vary from the standard of the samples, such bricks shall be rejected and removed from the site.

c. Uniformity:

The bricks selected for exposed pointed brickwork walls shall be of uniform colour, deep cherry red or copper colour and uniform texture. Only such bricks as are permitted by the Engineer shall be used.

d. Testing:

Samples of the bricks shall be tested in accordance with IS: 3495 by the Contractor for compliance with the aforesaid, before any order is placed, and soon after receipt of a consignment. Tests shall be carried out as and when required by the Engineer on samples selected by the Engineer's representative.

a. Laying:

Brickwork shall be uniformly bedded bricks being laid upwards. Each brick shall be floated and rubbed in upon such sufficient quantity of mortar that the mortar is squeezed up into the joints, but if such joints are not filled with mortar by this process they shall be flushed up with the mortar from the next succeeding bed. The courses shall be laid truly and strictly to line and horizontal level.

B. Bond:

Brickwork courses shall be alternately laid in stretcher bond and header bond. Damaged bricks shall not be used. The greatest care shall be taken to prevent mortar dropping on to or in any other way disfiguring or discoloring the bricks, and all edges and sides shall be kept strictly plumb and square, in-line, and flush with the required finished face. As the work proceeds, it shall be continuously checked with a 2 m long straight edge and spirit level.

c. Construction:

Walls shall be carried up in a uniform manner and no one portion raised more than 1 m above another at any one time, the open end being racked out. Over-hang work shall in no case be permitted. Brickwork shall be cleaned down after each day's work and newly laid brickwork shall be protected by suitable means.

d. Dry Weather:

In dry weather the suction rate of clay bricks shall be adjusted by wetting as necessary before use. Bricks shall be stored in a free draining area and protected from rain.

e. Lintels:

Where brickwork rests upon lintels or supporting ribs of concrete, the bricks shall be cut as necessary and carefully bedded so that proper support to the outer leaf of brickwork is obtained.

f. Pointing:

At the time of laying, all joint of exposed brickwork shall normally be raked out neatly and pointed to 15mm depth.

g. Approval:

All workmanship shall be strictly in accordance with the foregoing. The Engineer or the Engineer's representative reserves the right to reject any of the work on grounds of shabby workmanship. Such rejected work shall be removed and rebuilt to the Engineer's satisfaction.

Quantity of Mortar:

Quantity of mortar to be used in one Cum. of masonry shall vary from 0.30 Cum. for thin masonry to 0.32 Cum. for massive masonry of conventional bricks (second class).

Cement Mortar:

The cement mortar to be used on the work should be generally conform to specification contained in the PWD A/R. Only sufficient mortar shall be mixed as required for immediate use. Partly set mortar shall not be used.

2. Aggregates:

2.1 Sand for use in masonry and plaster works shall conform to relevant specification in I.S.2116/ 1985, I.S.1542/ 1977.

2.2 The coarse and fine aggregates for concrete shall conform to I.S.383/ 1970 and as specified in the relevant clauses of I.S.456/ 1978. Other aggregates free from deleterious materials shall be used at the concurrence and approval of the Engineer after sufficient tests have been carried out at the contractor's cost.

2.3 The maximum quantities of deleterious materials in the aggregates, as determined in accordance with I.S.2386 (Part II)/ 1963 shall not exceed the limits given in table I of I.S.383. Unless otherwise specified all coarse aggregate in RCC shall be graded aggregate of 20mm nominal size. All aggregates shall be stored in hard impervious surface to ensure exclusion of all foreign materials and as per IS 4082/ 1977.

2.4 Aggregate having a specific gravity below 2.6 (saturated surface dry basis) shall not be used without the special permission of the Engineer.

3. Water required for Construction:

3.1 The water used in the construction shall be of potable quality and shall be tested at the contractor's cost. The contractor has to make his own arrangements at his cost for water required for construction, testing, filling, etc., either from local bodies or from elsewhere, by paying the charges directly and arranging tanker etc., as per necessity. No claim for extra payment on account of non- availability of water nearby or extra lead for bringing water shall be entertained.

All required piping arrangements and pumping if required for water shall be made by the contractor at his cost. Water for mortar, mixing and curing of concrete shall be free from harmful matter or other substances that may be deleterious to concrete or steel and taken from a source approved by the Engineer. Ground water for mixing and curing shall conform to the provisions in the class 4.3 of IS 456/ 2000.

4. **Admixtures:**

Only where a beneficial effect is produced shall any admixture be used and that too after test has been carried out to convince the Engineer that no harmful effect will be produced by the use of such admixture and after approval by the Engineer. The admixture shall conform to IS 9103/ 1972

5. **Form Work and Centering**

5.1 Steel/ wooden form centering shall be used. If wooden form work is used, it shall consist of planks not less than 40mm thick and strong props. This shall be provided complying with clause 10 of IS 456/ 2000. The timber for form works shall be best hard wood and got approved by the Engineer in charge. This shall be deemed to be included in the items of contract even otherwise specified.

6. **Separator (Cover Block)**

6.1 For bottom cover of beams, slabs etc., separators of pre cast cement mortar blocks of suitable size with wire embedment as directed shall be used and tied to the reinforcement. Between layers of reinforcements, separators consisting of pieces of bars of suitable diameter shall be used. The required cover shall be provided as per clause 24-4 of IS 456/ 2000.

7. **Pipes, Specials and Valves**

7.1 General

7.1.1 All types of pipes required for the works should be of good quality conforming to relevant BIS and should be procured from reputed manufacturer or his authorized dealer. Each pipe should bear the trade mark of the manufacturer, the nominal diameter, class, weight, batch number and the last two digits of the year of manufacture suitably and legibly marked on it. The Engineer shall have the right to conduct any test to ascertain the quality of the pipes supplied by the contractor. The contractor should make all necessary arrangements for testing the pipes. All the charges and expenses towards the testing shall be borne by the contractor. The materials which are classified for ISI marking should be supplied with ISI marking only.

7.1.2 If on examination of any sample from any portion of the supply, the material is found to be substandard and not fully in accordance with the relevant specification, the entire consignment shall be rejected. In case of doubt whether the materials conform to the specification or not, the decision of the Executive Engineer shall be final.

7.2 Cast Iron pipes

Cast iron spun pipes shall conform to IS 1536/1976 Cast iron double flanged pipes shall conform to IS 7181/1986 and IS 1537. Cast iron fittings/specials shall conform to IS 1538/1986. All pipes and fittings (but excluding valves) shall be coated with an approved bitumen or coal tar paint.

Where the external coating of the pipes is damaged, the Contractor shall prepare and paint the damaged surface area with a minimum of three coats of bituminous paint and to the full thickness of original coating.

Spigot and socket joints shall be flexible and of an approved „push-in“ type unless otherwise specified.

The pipe shall bear ISI mark. The test certificate furnished by the manufacturer should be produced

7.3 D.I.pipes

The DI pipes shall be centrifugally cast (spun) for Water and Sewage and conforming to IS 8329-2000. The pipes used shall be both gasket joints and flanged joints. The minimum class of pipe to be used shall be class K-9 conforming to IS 8329. In general, pipes inside the buildings and below the structures shall be jointed as double-flanged pipes and those outside the building can be either EPDM gasket in accordance with IS 5382 and manufactured by the pipe manufacturer only. The pipes shall be supplied in standard lengths of 5.5m and 6.00m length with suitably rounded chamfered ends. Any change in the stipulated lengths will be approved by the Engineer's representative.

The flanged joints shall conform to the Clause 6.2 of IS 8329. The pipe supply will also include one rubber gasket for each flange.

7.3.1 Inspection and Testing:

The pipes shall be subjected to following tests for acceptance:

- (i) Visual and dimensional check as per clause 13 and 15 of IS 8329.
- (ii) Mechanical tests as per clause 10 of IS 8329.
- (iii) Hydrostatic test as per clause 11 of IS 8329.
- (iv) The test reports for the rubber gaskets shall be as per acceptance tests of the IS 5382 and in accordance to clause 3.8. The sampling shall be as per the provisions of the IS 8329.

7.3.2 Markings

All pipes shall be marked as per clause 18 of IS 8329 and shown as below:

- (i) Manufacturer name / stamp
- (ii) Nominal diameter
- (iii) Class reference
- (iv) A white ring line showing length of insertion at spigot end.

7.3.3 Packing and Transport

The pipes should be preferably transported by road from the factory and stored as per the manufacturer's specifications to protect them from damage.

7.3.4 Specials for DI Pipes

The DI specials shall be manufactured and tested in accordance with IS 9523 or BS 46.926.922. The mechanical test and hydrostatic test shall conform to clause 9 and clause 10 respectively of IS 9523. The tolerances on dimensions shall be as per IS 9523. The manufacturer of the pipes shall supply the fittings.

7.3.5 D I pipes shall be used in Pumping Main. DI pipes shall be procured from the reputed manufacturer and the pipe shall conform to IS 8329 / 2000. The pipes shall bear ISI mark. The test certificate furnished by the manufacturer should be produced

7.4 RCC Pipes

7.4.1 RCC pipes shall be manufactured with sulfate resistance cement and lined internally with high alumina cement by centrifugal process to resist corrosion and acid formation. RCC Pipes of sizes from 200 mm to 600 mm of NP3 class shall be used for sewer line, with rubber rings as the jointing material. The pipes shall conform to IS: 458 in regard to the internal diameter, type, class and 3 edge bearing strength. The pipe laying shall conform to IS 783.

7.4.1.1 Specification for High Alumina Cement Lined RCC Pipes:

The main purpose of using High Alumina Cement for lining is to protect the pipe against sulfate attacks when it is used in sewer lines. All reinforced concrete pipes shall be of spun concrete and lined with a 12 mm thick High Alumina lining.

The normal proportion of the mix shall be as follows:

- i. High Alumina Cement one part – as per IS: 6452.
- ii. Granite dust passing through IS sieve 150 micron – one part
- iii. Fine aggregate passing through IUS sieve 1.18 mm as per IS 383.
- iv. Water cement ratio of the lining mix shall not be more than 0.35 and shall be sufficient to ensure maximum density.

7.4.1.2 Process of manufacture

The pipes shall be made by spinning process. The centrifugal force generated by spinning action will force the concrete against the mould, removing excess resulting in a dense concrete. The mix for high alumina cement lining shall be mixed in small separation mixer. All the ingredients shall be weighed. As soon as the spinning pipe is completed, the cement mortar shall be fed into the rotating mould uniformly and the pipe shall be spun until the cement mortar is set.

7.4.1.3 Precaution to be taken for high alumina lining

- i. It is not desirable to mix and do the lining in high constant temperature (temperature more than 40° C)
- ii. Steam curing should not be used for curing pipes.
- iii. The high alumina lining shall be kept moist and cool for the first 24 hours. The curing of lining shall be started after 3 to 4 hours after operation.
- iv. The water cement ratio of the lining shall not be more than 0.35

7.4.1.4 Socket and Spigot

The outside of the spigot portion of the pipe shall be coated with epoxy coating and poly solution coating inside the socket portion shall be made before lowering into the trenches.

7.5 PVC pipes

7.5.1 The un-plasticized PVC-U rigid pipes shall strictly conform to IS 15328/2003 and as amended from time to time.

7.5.2 The contractor should procure the PVC-U rigid pipes from a reputed manufacturer

7.5.3 The contractor should furnish the test certificate issued by the manufacturer

7.5.4 The manufacturer's test certificate and third party inspection certificate should be produced by the contractor for the pipes used in the works

7.5.5 In addition to third party inspection, wherever felt necessary, the Engineer shall have the power to test the PVC pipes for its quality such as specific gravity, impact strength at 0° C, internal hydraulic pressure test, diameter, thickness etc.

7.5.6 The PVC pipe joints shall be with solvent cement of good quality, conforming to IS 14182/ 1994.

7.5.7 The Engineer in charge, shall verify, in addition to the test certificate, whether the pipes are as per BIS, by visual examination, diameter, weight, wall thickness, flexibility, colour etc.

7.5.8. All the PVC specials required for use in conjunction with PVC pipes, should be got approved by the Engineer-in-charge.

7.6 Stoneware pipes

- 7.6.1 The stoneware pipes shall strictly conform to IS 651/ 1992 and as amended from time to time.
- 7.6.2. The contractor should procure the stoneware pipes from a reputed manufacturer
- 7.6.3 The contractor should furnish the test certificate issued by the manufacturer
- 7.6.4 The manufacturer's test certificate and third party inspection certificate should be produced by the contractor for the pipes used in the works
- 7.6.5 In addition to third party inspection, wherever felt necessary, the Engineer shall have the power to test the stoneware pipes for its quality such as internal hydraulic pressure test, diameter, thickness, crushing strength etc.

7.7 CI D/F pipes

- 7.7.1 The CI D/F pipes procured for use in the work should conform to the relevant BIS specification NO.7181/1986 and suitable for use in the work.

7.8 Valves

- 7.8.1 The contractor should procure reputed make of sluice valves, scour valves, reflux valves and air valves from the manufacturer or his authorized dealer and they should conform to the relevant BIS specification and suitable for use in the work. The valves shall bear ISI marks.

7.9 CI / PVC / Specials and Fittings

- 7.9.1 The specials and fittings should be in conformity to the relevant BIS specification

7.10. Testing of Pipes

- 7.10.1 The manufacturer test certificate/ third party inspection certificate should be produced by the contractor for the pipes used in the work. The engineer shall have the right to test the pipes, wherever felt necessary for its quality. All testing charges should be borne by the contractor.
- 7.10.2 Testing of materials to be used in works, for the quality of finished items shall generally be done by the contractor at his own cost in the laboratory approved by the Employer by providing requisite materials, transport of test specimen and other assistance required thereof.

8.0 M S Ladder

Supplying and fixing M S ladder 450 mm wide and required height with 40 mm x 5mm thick MS flat on either side and 16 mm round bars at 200 mm intervals. Two coats of anti-corrosive paint over one coat of red oxide is to be painted.

9.0. Un-plasticized Poly Vinyl Chloride (UPVC) Pipes

The latest versions of Indian standards and codes of practice shall be adhered to for the design, manufacturing, inspection, factory testing, packing, handling, and transportation, laying, and jointing of the UPVC pipes. The rubber rings shall be vulcanized from Ethylene Propylene (EPDM) conforming to IS 5382. The UPVC pipes shall be of minimum 4 kg / cm² and as per IS 4985 and the pipes for plumbing works in office building shall be SWR (Type B) as per IS 13592, with electrometric sealing rubber ring joints. The method of sampling of rubber rings should be in accordance with IS 5382. The material from which the pipes are made shall consist substantially of un-plasticized polyvinyl chloride conforming to IS 10151, to which only those additives shall be added that are absolutely needed to facilitate the manufacture of the polymer and the production

of sound, durable pipes of good surface finish, mechanical strength and opacity. The total quantity of additives like plasticizers, stabilizers, lubricants and fillers shall not exceed more than 6.92.0%. The bulk density of UPVC pipes shall be 1.39 to 1.44 g/cm³. The PVC resin of suspension grade K-66/K-66.92 shall be used for extrusion of UPVC pipe. The UPVC fittings shall be fabricated from Class 4 UPVC as per IS 4985.

9.1.1 Tests on Material:

Following in house tests shall be carried out on the raw material:

- (i) Grade (K-value)
- (ii) Particle size distribution
- (iii) Bulk density of resin
- (iv) Bulk density of compound

9.1.2 Test on Pipes:

The acceptance test shall be conducted in accordance with IS 4985 and in presence of the Engineer's representative—

- (i) Visual and dimensional check
- (ii) Reversion test
- (iii) Vicat softening test
- (iv) Ash Content
- (v) Bulk density
- (vi) Resistance to external blows
- (vii) Internal hydrostatic pressure test for pipes and joints
- (viii) Opacity

9.1.3 Marking on Pipe:

Each pipe shall be clearly marked as indicated below:

- (i) Manufacturer's name and trade mark
- (ii) Outside diameter (OD) in mm
- (iii) Class of pipe and pressure rating
- (iv) Month and year of manufacturing
- (v) Length of pipe
- (vi) Marking of insert depth of spigot

9.1.4 Marking on rubber ring:

Each sealing ring shall be permanently marked with

- (i) The manufacturer's name or trade mark.
- (ii) The month and year of manufacture
- (iii) Diameter of pipe for which the ring is suitable.
- (iv) Type of rubber material

9.1.5 Tests on rubber ring:

Following tests shall be conducted on rubber rings conformity:

- (i) Hardness
- (ii) Tensile strength
- (iii) Elongation at break
- (iv) Compression set
- (v) Accelerated ageing
- (vi) Water Absorption
- (vii) Stress relaxation

IV. CIVIL WORKS

1. General:

1.1 National Building Code and State PW specifications shall be strictly followed for carrying out different items of the work for which no standard specifications are available and no alternate specification have been given under the description of works.

1.2 Where any provision of the State PW specification is repugnant to or at variance with any provision under BIS or description of work, technical specifications and conditions of contract, the provisions of the latter shall be deemed to supercede the provision of the former.

2. Earth Work:

2.1 Specification

State PW specification shall be followed for earthwork excavation.

2.2 Conveyance

The excavated earth, blasted rubble etc., shall be conveyed and deposited in suitable places as directed by Engineer in charge within 150m of plant site on one side of the trench only.

2.3 Disposal of Surplus Earth

The excavated soil which is surplus to that required for refilling and after allowing for settlement will have to be removed, spread and sectioned at places shown on the site during execution for purpose of widening or levelling the road. The cost of removal of surplus earth after spreading/leveling/sectioning at site approved by the Engineer-in-charge to the disposal site will be measured under the relevant item of work in BOQ.

2.4 Shoring, Strutting and Baling out Water

The rate for excavation of trench work shall include charges of bailing out water wherever necessary and no extra payment will be made for any of these contingent works. While bailing out water, care should be taken to see that the bailed out water is properly channelized to flow away without stagnation or inundating the adjoining road surfaces and properties.

For shoring and strutting, the rate for excavation for the first 2 m depth from G.L. shall include. Shoring and strutting beyond 2m depth from G.L., payment will be made as per respective item in BOQ.

3. Concrete:

3.1 Specification

Concrete for use in the works shall generally comply with the relevant BIS. The concrete mix shall be in specified proportions satisfying the maximum aggregate size, water cement ratio and required cube strength and workability as per IS 456-2000. Such concrete must be adequately vibrated to form solid mass without voids. The entire concreting works should be done only with the prior approval and in the presence of Engineer in charge.

3.2 Mixing of Concrete

The concrete shall be proportioned as far as cement and aggregates are considered by volume. The amount of water required being measured either by weight or volume the adjustments must be made to frequent intervals at the discretion of the Engineer or his assistant to account for the moisture content of the aggregates. The mixing operation shall be performed only in a mechanical concrete mixer and shall continue until the whole batch of uniform consistency and colour. The mixing of concrete shall be done in accordance with clause 8 and 9 of IS 456-2000.

3.3 Transporting, Placing and Compacting Concrete

3.3.1 Transportation, placing and compaction of concrete mix by mechanical vibrators shall be done in accordance with clause 12 of IS 456-2000. It is imperative that all concreting operations be done rapidly and efficiently with minimum re-handling and adequate manpower shall therefore, be employed to ensure this.

3.3.2 The forms shall be first cleaned and moistened before placing concrete.

3.3.3 The mix should not be dropped from such a height as it may cause segregation and air entrainment. When the mix is placed in position, no further water shall be added to provide easier workability.

3.3.4 No concrete mix shall be used for the work if it has been left for a period exceeding its initial setting time before being deposited and vibrated into its final position in the member.

3.3.5 While one concrete is being placed in position it shall be immediately spreaded and rammed sufficiently and suitable to attain dense and complete filling of all spaces between and around the reinforcement and in to the corners of form work for ensuring a solid mass entirely free from voids.

3.3.6 Construction joints required in any of the structural members shall be provided generally complying with clause 12.4 of IS 456-2000 and as directed by the Engineer in charge. The efficiency of tempering and consolidation will be judged by complete absence of air pockets, voids and honey combing after removal of form works.

3.4 Curing:

3.4.1 Curing shall be done to avoid excess shrinkage or harmful effort to the members generally complying with clause 12.5 of IS 456-2000.

3.4.2 The method adopted shall be effective and any special method used must be approved by the Engineer and be subject to complete supervision.

3.4.3 Any deficiency in concreting such as cracking, excessive honeycombing, exposure of reinforcement or other fault which entail replacement of the defective part by fresh concrete and whatsoever remedy reasonable required without hampering the structural safety and architectural concept, all at the cost of contractor.

3.5 Removal of Form Work:

3.5.1 Removal of form work shall be done as per I.S.456/2000 and as directed by the engineer in such a manner that no damage is caused to the concrete work.

3.6 Testing of Concrete:

3.6.1 During the course of construction works, preparation of test specimens, curing and casting of concrete shall be done in accordance with IS 1199 and IS 516 to ascertain the strength requirements and acceptance criteria indicated in IS 456-2000. The contractor shall provide all apparatus, labour and arrange to test the cubes at his own cost at the test laboratory decided by the Employer.

3.6.2 In addition to the above tests, any other test which may if desired by the Engineer in charge be carried out from time to time as per relevant specifications at the cost of contractor. In case the concrete does not meet the strength required, all corrective measures shall be taken at once at the contractor's cost.

3.6.3 The inspection and testing of structures shall be done in accordance with clause 16 of IS 456/ 2000.

4. Masonry:

4.1 All masonry works such as Random Rubble / Coarse Rubble / Brick work must be done as per Bid schedule specification.

5. Plastering:

5.1 Plastering would be 12mm, 20mm and 25mm thick cement plaster either plain or with water proof cement as may be specified.

5.2 The plastering items shall be executed in thickness and cement mortar of proportion as detailed in respective item in the BOQ. Similarly, the plastering shall be either ordinary or with water proof for components as specified in respective item in the BOQ.

5.3 In case of water proof plaster standard and approved water proofing compound shall be mixed in cement mortar in required percentage as directed and then the plaster is applied.

5.4 The finishing shall be either smooth or rough as may be directed by the Engineer unless otherwise specifically mentioned in the BOQ.

5.5 Neat finish wherever directed by the Engineer shall be done at no extra cost.

5.6 Curing and watering shall be done as directed and plaster shall be in alignment and level. Any substandard work is liable to be rejected and shall have to be re-done at contractors cost. Sand to be used shall be of approved quality only. Cost of all scaffolding shall be included in the rates quoted in the BOQ.

6. Flooring:

6.1 40mm thick cement concrete 1:2:4 shall be provided for flooring. The size of metal shall not be more than 12mm and it shall be properly graded. A thin coat of very fine plaster shall be provided on top to give a smooth finish. The marking of false grooves to surfaces as directed includes the cost of labour.

7. Doors and Windows:

7.1 Sizes shown on drawings are clear openings in masonry and not the shutter's size. These sizes shown on drawings are, therefore, inclusive of required frame sizes and doors, windows, etc., and shall be manufactured, accordingly. If sizes bigger than shown in drawings are manufactured, as instructed specifically in writing they shall be measured and paid for accordingly.

7.2 The work shall be executed as per the size of frame thickness of shutter type viz. Plain planked panelled, glazed, etc., and fixture, etc., as described in tender item. Iron bars for windows and ventilators are to be provided if specifically mentioned in the tender item at Contractor's cost. Specifications in State PW SR shall be applicable.

7.3 The design of shutters and quality of wood shall be got approved from the Engineer-in-charge before manufacture. The CW/TW to be used for woodwork shall be uniform in substance straight, free from large dead knots, flows flanks. The work shall be done as per specification of SoR/AR of State PW / PH latest edition. The joints shall be perfect.

7.4 Part of wood embedded in masonry shall be painted with the tar. The frames of doors, windows, ventilators, etc., shall have proper hold-fasts embedded in masonry.

7.5 Whenever iron bar is to be provided as per tender item the rate thereof is included in tender item. The painting shall be done as prescribed in tender item. No painting, however, shall be permitted till the woodwork is approved by the Engineer-in-charge.

7.6 Any substandard work not conforming to the specifications are liable to be outright rejected and Executive Engineer's decision in such cases shall be final and binding on the Contractor.

7.5 The mode of measurement shall be on area units as mentioned in BOQ.

8. Painting:

8.1 The work shall be carried out as per the description of the tender item and as directed by Engineer-in-charge. It shall be white washing, distempering and /or cement painting. Shade and make shall be as directed by the Engineer and for decorative purpose, Engineer may ask for different shades to be provided for different components or different parts of the same component which the Contractor shall have to do within his tendered rate only at no extra cost to the Employer. Cost of priming coat as directed, scaffolding, etc., shall be included in the tender rate. The work shall be executed as per the specifications of PWD for painting.

In general, all items of works must be done as per PW specifications and bid schedule specifications

9. Wet Well:

Diversion of Surface Flow and Isolating the Site of Work

9.1 The contractor himself has to arrange for necessary diversion of surface flow for isolating the site of work for construction of collection well, pump house and other allied works. The bund for diversion should be well formed in such a manner that there may not be any breach during the progress of work and the same should also be maintained in good condition till the work is completed.

9.2 The contractor will be personally responsible for any damages caused to the work due to any breach in the diversion formed during the progress of work.

9.3 The Employer will not take any cognizance of any damage to the materials or the equipment required for the work and kept in the river bed or in the bank due to any cause whatsoever it may be. The contractor should take necessary precaution against floods, theft or any loss or damage occasioned by or arising out of act of God and in particular unprecedented floods etc. The contractor shall arrange for risk insurance at his cost for the above cause.

10. Earthwork Excavation:

10.1 The levels in the drawings are only approximate for the guidance of the contractor in general. From the date of execution, the bed level and the sub soil water level as noted will be reckoned. Thus the payment will be regulated according to the sub soil water level observed.

10.2 In regard to the width of the excavation of work above or below water level, sketch will be furnished to the contractor and payment will be restricted as per section shown in the plans irrespective of the facts that the contractor excavates the same with more side slopes for his own convenience.

10.3 The contractor has to fix up and maintain necessary sight rails and ranging rods etc. as required by departmental officers for checking the various levels.

11. Excavation for Foundation:

11.1 Unless otherwise specified open well excavation shall be resorted to up to water levels as directed by the Engineer.

11.2 All precautionary measures for the safety of labourers while excavation shall be made as per the relevant BIS. for safety code for earth work

11.3 The quantities furnished in the BOQ are only approximate. Any omission or excess in quantities may arise during execution according to the site condition. Any alteration of work or any additional work during execution has to be done by the contractor. If no rate in the BOQ is applicable or derivable for the additional works, the rates will be arrived at as per rules and regulations governing for the working out of rates for supplemental item of work and will be paid to the contractor.

V. SPECIAL SPECIFICATION FOR SEWERAGE WORKS

1. Sight rails and Boning rods

1.1 The works will be set out by the Contractor. The Contractor shall be required to fix over the center of each manhole or where a change in direction or gradient occurs a strong timber sight rail, 150mm x 25mm with top edge placed straight and true. These shall be supported and fixed to stout wooden posts at each side of the excavation. The center line of the sewer shall be marked on each sight rail both back and front by a single vertical line drawn thereon and on other side white. All lengths of sewer shall have three sight rails fixed one at each end and one in the center and worked one with the other. The boning rods shall have a movable cross head at right angles to the rod. So arranged that it can slide up and down the rod and capable of being fixed at any required position on the rod by screws. The foot of the boning rod shall be provided with the shoe made truly at right angles to the rod so that when placed on the pipe being laid it shall rest properly on the pipe when the rod is truly vertical.

2 Laying and jointing of stoneware pipe not on concrete

2.1 Before laying the pipes, the Contractor shall carefully brush them to remove any soil, stones or other materials which may be therein, even and regular bed having been prepared, and joint pit excavated to form a recess under the socket of each pipe of no greater width and depth than to enable the pipe jointing to be properly done. Each pipe shall then be carefully lowered and placed singly in the trench and shall rest on the solid ground for a distance of not less than two thirds of its entire length.

2.2 Each pipe shall be brought into a true line from manhole to manhole, for this purpose, a strong twin line (rat thread) sufficiently long to reach the full length between manholes shall be used. Each pipe shall be set correctly to level by means of the boning rod and sight rails.

2.3 The spigot of each pipe shall be carefully wrapped with a ring a spun yam dipped in cement grout or tarred gasket sufficiently thick to properly fit the socket of the adjoining pipe and to allow true alignment. The Pipe shall then be driven fully home into the socket of the adjacent previously laid pipe and yam or tarred gasket carefully driven home with caulking tool.

2.4 The remaining space in the socket shall then be tightly and completely filled with cement mortar composed of one part of Sulfate resisting Portland cement and one and a half parts sand and shall be neatly beveled off all round the circumference and finished at an angle of 45 degree outside the socket of the pipes. A wooden caulking tool shall be used for forcing the mortar into the sockets.

2.5 A tightly fitting bag of shavings or straw having a rope attached shall be drawn through the pipes as the work proceed to ensure that there is no cement or yam or other obstruction projecting into the interior.

2.6 All joints shall be kept moist either by means of wet bags, wet clay or wet earth which ever may be ordered by the engineer to protect them from the sun. Such covering shall be removed when the length is tested for water tightness.

3. Laying stoneware pipes on Concrete

3.1 In trench where ordinary socket and spigot stoneware pipes are to be laid on concrete bed, the method to be adopted is as follows,

3.2 When the earth is taken out to the proper depth and gradient, a concrete bed of suitable thickness and width is to be laid as directed by the Engineer. The top of this concrete bed shall also be to the required gradient

3.3 When the concrete has set sufficiently, a series of special concrete invert blocks are to be laid about 60cm apart and leveled so that their top surface may be exactly the level of the sewer invert, less the thickness of the pipes. The correctness of level of the pipes is to be ascertained by working a straight edge from the invert of each pipe to block ahead.

3.4 The pipe must also be checked at intervals for the proper line and level and the first pipe of any length must be very carefully bedded and leveled into position.

3.4 The object to be obtained by the method above described is to ensure that the outside of the sockets shall be raised approximately 25mm above the concrete bed in order to allow the joints to be made properly in the underside.

3.5 In his prices for laying concrete, the Contractor must allow for doing the work in the manner as above described including cost of blocks.

4 Junctions on stoneware pipes

4.1 Where shown on the drawings or where directed by the Engineer Junctions pipes shall be provided at intervals during the construction of sewers, the jointing being effected in a similar manner to the pipe of the sewer in which they are placed.

4.2 These junction arms shall be closed with stoneware or cement disc and the sockets filled with cement mortar. The trench shall not be filled in until the position and orientation of each junction has been measured and recorded by the Engineer.

5 Manholes

5.1 Manholes shall be constructed on the sewers in the positions shown in the drawings or in such position as the Engineer may direct. The work shall be done strictly in accordance with the detailed drawings except where alterations are required by the Engineer. The excavation shall not be larger than that sufficient to admit of the trench being properly timbered and to facilitate plastering outside. The bottom of the excavation shall be properly leveled up, rammed and a bed of concrete laid thereon. When the concrete has sufficiently set the construction of the brick walls shall then be proceeded with and all stoneware pipe connections through the walls shall be made and all iron work fixed in as constructions proceeds. Sulfate resisting Portland cement shall be used for construction of manholes. Manhole less than 2.5m from invert to sewer to ground level shall be built rectangular and shall have a flat top constructed as shown in the drawings, Manholes more than 2.5m from surface to invert shall be built circular and the walls corbelled as shown in the drawing. The inside of all manholes shall be plastered with cement mortar 1:3 20mm thick and outside of all manholes with cement mortar 1:3 12mm thick. The manholes bottoms shall be properly formed with stone ware channels fixed in cement mortar. The channels shall be neatly formed to the radius of the pipe and all side connection curved and channeled to admit the sewage to entire at an angles of 45° to the line of flow Manholes shall be topped with a circular cast iron frame with cover or cover of such pattern as may be ordered by the Engineer. The manhole frame shall be fixed to the top of the brick work by a layer of cement mortar.

5.2 Where pipes pass through walls of manholes relieving arches shall be turned neatly over the upper half of the pipes. If any pipe enters at such an angle that a relieving arch cannot be properly turned the bricks shall be carefully cut and laid so as to fit closely and neatly against the pipe, and a RCC lintel shall be provided to avoid load of the walls being transmitted to the pipes.

5.3 The stoneware drop pipe connection in manholes shall be secured to the wall of the manholes by suitable clamps and shall be built in as the work proceeds in accordance with the drawings and the above instructions. The cost of this work will be paid separately.

5.4 PVC encapsulated steps shall be built in each manhole as the work proceed one being inserted to every four courses of brick work, horizontal distance center to center of each row being 30cm

5.5 The Contractor shall include in his prices for completing all manholes in accordance with the drawings.

6 Cleaning out Sewers and Manholes

During the whole of the work the contractor shall keep interior surface of sewers and manholes free from cement mortar, bricks, soil or other superfluous matter and shall handover the sewers perfectly clean and free from deposit on completion.

7 Water Test of Sewers

7.1 All sewers shall be tested before the filling in of the trench or other excavations. Testing shall also be done after refilling of the trench or other excavation, if considered necessary by the Engineer. The testing or retesting shall be carried out by and at the expenses of the Contractors who shall also provide the necessary appliances and water for the same. The tests will only be made from manhole to manhole after the manholes connected with the length under test have been completely finished.

7.2 The test shall be carried out in the following manner.

7.2.1 The pipes shall be carefully cleared of all earth or materials that may be lying thereon or therein and all joints shall be exposed right round so that through examinations may be made while the pipes are under test.

7.2.2 The ends of the pipe shall be closed by means of expanding stoppers and all junctions with stoneware stoppers or cement disc fixed in cement mortar.

7.2.3. The last but one pipe at the higher end of the length shall be a junction pipe with the junction arm at the top which will permit of the filling of length with water and also allow the escape of all air in the pipes.

7.2.4 The expanding stoppers at each end of the length under test shall have a hold in the center with a small piece of a pipe screwed therein and threaded on the projecting piece to permit of a flexible tube not less than 2m long fixed there to by a coupling. At the end of the tubing, the following shall be fixed.

- a) at lower end of length, a sock.
- b) at top end of length, a funnel of 15cm diameter.

7.2.5 The top of the runnel shall be fixed rigidly at a height of 30cm above the ground level, or such other height as may be decided by the Engineer.

7.2.6 After the above-mentioned expanding stoppers have been fixed together with flexible tubing and funnel, the length shall then be filled with water through the junction arm of the pipe provided therefore. As soon as the water has risen of the level of the filling junction arm an expanding stopper shall be fixed thereon. After a short time has been allowed for absorption, water shall be poured into the funnel until the same is filled to the top.

7.2.7 If any of joints are leaking or if during a period of ten minutes the water level in the funnel drops 25mm or more (no more water being added or sewer interfered with in any way during the period) the test shall be considered unsatisfactory. If the water does not drop more than 25mm and there is no sign of leakage at any of the joints, the test shall be continued for one hour and at the end of the hour the pipe lines including the joints shall be examined and, if no indication of sweating or leakage is found then the test will be considered satisfactory. Should the test be unsatisfactory, all such joints or pipes found to be defective shall be removed, replaced or re-laid to the satisfaction of the Engineer by the Contractor at his cost.

7.2.8 The test shall be done as many times as may be necessary until the length is found to be watertight to the satisfaction of the Engineer.

7.2.9 The water required for testing shall be clean.

8. Providing, Laying and Jointing of Pipes & Fittings:

Scope:

This specification covers the requirements for providing, laying & jointing of stoneware, RCC, CI, pipes used for the sewerage system as per the relevant IS & National building code.

Materials:

Salt glazed stoneware pipes:

The stoneware pipe to be used shall be of the approved make and shall conform to IS:651-1980. All pipes shall be perfectly straight and truly cylindrical, glazed inside and outside, free from cracks and flaws, and perfectly burnt. Those not conforming to above mentioned requirements shall be rejected. The pipes used in the project shall be of 200mm, 250mm, 300mm, 350mm & 375mm.

RCC pipes:

RCC pipes shall be manufactured with sulfate resistance cement & lined internally with high alumina cement by centrifugal process to resist corrosion and acid formation. RCC pipes of sizes from 200mm to 600mm of NP3 class shall be used for sewer line, with rubber rings as the jointing material. The pipes shall conform to IS:458 in regard to the internal diameter, type, class and 3 edge bearing strength. The pipe laying shall conform to IS 783.

Specification for High Alumina Cement Lined RCC Pipes: General:

The main purpose of using High Alumina Cement for lining is to protect the pipe against sulfate attacks when it is used in sewer lines. All reinforced concrete pipes shall be of spun concrete and lined with a 12mm thick High Alumina lining.

The normal proportion of the mix shall be as follows:

1. High Alumina cement - one part - as per IS: 6452
2. Granite dust passing through IS sieve 150 micron - one part
3. Fine aggregate passing through IS sieve 1.18mm as per IS 383
4. Water cement ratio of the lining mix shall not be more than 0.35 and shall be sufficient to ensure maximum density.

Process of Manufacture:

The pipes shall be made by spinning process. The centrifugal force generated by spinning action will force the concrete against the mould, removing excess resulting in a dense concrete. The mix for High alumina cement lining shall be mixed in small separation mixer. All the ingredients shall be weighed. As soon as the spinning of pipe is completed, the cement mortar shall be fed into the rotating mould uniformly and the pipe shall be spun until the cement mortar is set.

Precaution to be taken for high alumina lining:

1. It is not desirable to mix and do the lining in high constant temperature (temperatures more than 400 c.
2. Steam curing should not be used for curing pipes.
3. The high alumina lining shall be kept moist and cool for the first 24 hours. The curing of lining shall be started after 3 to 4 hours after operation.
4. The water cement ratio of the lining shall not be more than 0.35

Socket and Spigot:

The outside of the spigot portion of the pipe shall be coated with epoxy coating & poly solution coating inside the socket portion shall be made before lowering into the trenches.

Cast Iron pipe and fittings:

Cast iron pipe of LA clause shall conform to IS:1536 and fittings as per IS:1538 and laying shall be as per IS:3114. The test procedure, the scale of sampling and the criteria for acceptance of rubber rings shall be as per IS 5382 and IS 3400 in case of rubber ring joints.

The spigot socket joints shall be with lead joints. The lead jointing is done by first caulking in spun yarn and then filling the remainder of the joint space by running in molten lead, taking care that no extraneous material enters the joint and then thoroughly caulking the lead. The spun yarn shall be used to center the spigot in the socket and to prevent the flow of molten lead in to the bore of the pipe. The CI flanged pipes and specials shall conform to IS 1538. After laying and jointing of CI pipes and fittings the pipe line shall be tested at work site in suitable stretches before back filling excavated earth, as per specifications.

Manhole-frames & cover:

The manhole frames & covers shall be of fibre reinforced concrete with clear opening of 600mm diameter pipe & of heavy duty type to withstand heavy load of traffic (i.e IRC class AA load). The manhole frame & cover shall conform to IS.12592 part I of 1982. It shall be inspected before supply by the Engineer in-charge.

Manhole steps:

The footrest or steps for entry into the manhole or flush tank shall be of plastic encapsulated steps instead of Cast iron steps generally used. The plastic encapsulated steps shall be of 3mm thick plastic encapsulated as per IS - 10910 on 12mm dia steel bar as per IS - 1786 having minimum cross section as 23 x 25mm and overall minimum length 263mm and width as 165mm with minimum 112mm space between protruded legs having 2mm tread on top surface by ribbing or chequering besides necessary and adequate anchoring / projection on tail length of 138 mm and suitable to withstand the bend test, twist test, plastic integrity test and chemical resistance test as per detailed specification. The manhole steps shall be inspected before supply by the Engineer in-charge.

Carting & Handling of pipes / specials:

Pipes and fittings / specials shall be transported from the factory to the work sites as directed by owner / engineer. Contractor shall be responsible for the safety of pipes and fittings / specials in transit, loading / unloading. Every care shall be exercised in handling pipes and fittings / specials to avoid damage. While unloading, the pipes and fittings / specials shall not be thrown down from the truck on to hard surfaces. They should be unloaded on timber skids with steadying ropes or by any other approved means. Padding shall be provided between coated pipes, fittings / specials and timber skids to avoid damage to the coating. Suitable gaps between pipes should be left at intervals in order to permit access from one side to the other. In case of spigot socket pipes, care should be taken regarding orientation of pipes while unloading. As far as possible pipes shall be unloaded on one side of the trench only. The pipes shall be checked for any visible damage (such as broken edges, cracking or spalling of pipe) while unloading and shall be sorted out for reclamation. Any pipe which shows sufficient damage shall be prohibited.

Storage of pipes:

Each stock of pipes shall contain only pipes of same class and size, with consignment or batch number marked on it with particular of supplier wherever possible. Storage shall be done on firm level and clean ground and wedges shall be provided at the bottom layer to keep the stack stable. The stack shall be in pyramid shape of the pipes laid lengthwise and crosswise in alternate layers. The pyramid stack shall be made for smaller diameter pipes for conserving space in storing

them. The height of the stock shall not exceed 1.5m. Fittings / specials shall be stacked under cover and separated from pipes.

Rubber rings shall be stored in a clean, cool place away from windows, boiler, electrical equipment and petrol, oils or other chemicals. Particularly in the field where the rubber rings are being used it is desirable that they are not left out on the ground in the sun or overnight under heavy frost or snow conditions.

9. TRENCH EXCAVATION

General:

Trench excavation means excavation of trenches into which the pipe is to be laid. The line and levels of trenches shall be as shown on the drawings or as may be directed by the Engineer-in-charge. Before commencing trench excavation, the route of the trenches shall be pegged out accurately and the natural ground levels shall be agreed with the Engineer-in-charge.

Width of Trench:

The width of trench measured at the crown of the pipe shall permit adequate working space. The trenches shall be widened at sockets and other structures as may be found necessary. Payment for excavation shall be made on quantity basis as per actual dimensions of trench excavated subject to the condition that the quantity shall be limited as per the trench cross-section necessary to keep the trench in vertical position.

Depth of Excavation of Trenches:

The depths for the trenches will be calculated from the surface to the invert of the manholes for the pipes. The trench shall be so dug that the pipe line may be laid to the required gradient between the adjacent manholes and to the required depth. A minimum cover of 0.9 m is to be taken above the crown level of pipe up to the ground level / road level.

Barricading by Fencing, watering, lighting:

The parts of the fencing shall be of timber, securely fixed in the ground not more than 2.50 m. apart. They shall not be less than 10cm in dia or not less than 1.25 m above the surface of the ground. There shall be two rails, one near the top of the post and the other about 0.5m above the ground and each shall be of 5 cm to 10cm in diameter and sufficiently long to run from post to post to which they shall be tied with strong ropes. The method of projecting rails beyond the posts and tying together where they meet will not be allowed on any account. All along the edges of the excavated trenches, a bund of earth about 1 m high shall be formed when so required by the Engineer for further projection. Proper provision shall be made for lighting at night and watchman shall be kept to see that this is properly done and maintained. In addition to the normal lighting arrangements the contractor shall provide, whenever such work is in progress, battery operated blinking lights (6 volts) in the beginning and end of a trench with a view to provide suitable indication to the vehicular traffic. The contractor shall also provide a display special board printed with fluorescent prints indicating the progress of work along the road. In the event of the contractor not complying with the provisions of the clause, they will be imposed fine which will be decided by the Engineer. Further, in all such cases, the work may be carried out at the risk and cost of the contractor. The Contractor shall be held responsible for all claims for compensation as a result of accident or injury to persons during the course of execution of the project.

The contractor shall at his own cost provide all notice boards before opening of roads as directed by the Engineer. Arrangements shall be made by the contractor to direct traffic when work is in progress.

Blasting for pipe laying:

In case of excavation in rock whether by chipping or chiseling in crowded localities or blasting using explosives in other localities, pre measurement of the area to be removed shall be got approved by the engineer in-charge. After the excavation is completed, the rocky material shall be stacked & got measured by the engineer, so that the removed & stacked material shall agree for the purpose of payment.

In case of refilling of the trench, where the pipes are to be laid in rocky strata, the pipe shall be laid true to line & gradient over proper bedding & while the sides & the top of the pipes shall be refilled with borrowed earth from adjoining areas or conveyed earth from other areas. Blasted materials shall not be used for refilling the trenches.

Trench excavation in roads and footpaths:

All trench excavation and other work carried out within the limits of any road shall be completed as rapidly as possible and not more than half of the width of the carriage way shall be obstructed at one time. Road drains shall be kept free from obstruction. In any event the Contractor shall take special precautions, which shall include the continuous support of the sides of the excavation, from the time when excavation is begun until the refilling of the trench in places, to ensure that there is no disturbance of the adjacent road or road foundation.

Where excavated material has temporarily been deposited on a grass margin or road pavement, the margin or road pavement shall on completion of refilling be restored entirely to its original condition to the satisfaction of the concerned department and left free from loose stones.

Trench excavation in fields:

The term "fields" includes fields, moorlands, grass verges and the like and all private lands, and no length of trench excavation located in fields shall be commenced until suitable temporary fencing has been erected around that length unless the Engineer permits otherwise. Temporary fencing shall not be removed without the Engineer's permission, which will not normally be given until the Trench Excavation has been refilled and reinstated to the original ground condition or as directed by the Engineer.

The contractor shall have particular regard to the safety of livestock in fields or which may be introduced to the fields, and shall ensure that all open excavations, access routes and steep or loose slopes arising from the contractor's operations in these fields are adequately fenced and protected.

After the erection of temporary fencing the Contractor shall remove top soil to such depth and over such area as may be necessary to provide sufficient material to ensure adequate surface reinstatement of the working areas occupied by the contractor for construction of the pipe line.

Trench sides:

Loose boulders shall be removed from the sides of the trenches before allowing workmen into the excavation, and the trench sides shall be stabilized with screening or other methods approved by the Engineer. Trench slopes shall be kept moist where necessary to prevent local sliding as ordered by the Engineer.

Timber shoring:

Shoring & strutting has to be done for the total depth of trench including the top 2m when the depth of the trench exceeds 2m & above in loose soil. Shoring & strutting has to be done for both sides of the trench. However, when the depth is less than 2m shoring need not be done. Close timbering shall be done by completely covering the sides of the trenches and pits generally with short, upright members called 'rolling boards'. The boards shall generally be placed in position vertically side by side without any gap on each side of the excavation and shall be secured by horizontal

walling of strong wood at maximum 1.2 meter spacing and suitably strutted. If the soil is very soft and loose, the boards shall be placed horizontally against each side of the excavation and supported by vertical walling, which in turn shall be suitably strutted. The lowest boards supporting the sides shall be taken into the ground and the portion of the vertical side of the trench or pit shall remain exposed, so as to render the earth liable to slip out.

The shoring material shall not be of sizes less than those specified below unless steel sheet piling is used or unless otherwise approved by the Engineer in writing:

- | | | | |
|----|---------------|---|-------------|
| a) | Planks | - | 5cm x 25cm |
| b) | Waling pieces | - | 10cm x 20cm |
| c) | Struts | - | 15cm x 20cm |

Timber shoring shall be 'close' or 'open' type, depending on the nature of soil and the depth of pit or trench. The type of timbering shall be as approved by Engineer. It shall be the responsibility of the contractor to take all necessary steps to prevent the sides of excavations, trenches, pits, etc., from collapsing.

In the case of open timbering, the entire surface of the sides of trench or pit is not required to be covered. The vertical boards of minimum 25cm x 4cm sections shall be spaced sufficiently apart to leave unsupported strips of maximum 50cm average width. The detailed arrangement, sizes of the timber and the spacing shall be subject to the approval of the Engineer. In all other respects, the specification for close timbering shall apply to open timbering.

In case of large pits and open excavations, where shoring is required for securing safety of adjoining structures or for any other reasons and where the planking across sides of excavations / pits cannot be strutted against, suitable inclined struts supported on the excavated bed shall be provided. Load from such struts shall be suitably distributed on the bed to ensure no yielding of the strut.

Inspection by engineer:

When the required levels of trench excavation are reached, the Engineer will inspect the ground exposed and if he considers that any part of the ground is by its nature unsuitable he may direct the Contractor to excavate further and to refill the further excavation with such material as he may direct.

Should the bottom of any trench excavation while acceptable to Engineer at the time of his inspection subsequently become unacceptable due to exposure to weather conditions or due to flooding or have become puddle soft or loose during the progress of the works the contractor shall remove such damaged, softened or loosened material and excavate further.

Disposing material from trench excavations:

The Contractor shall make his own arrangements for the temporary storage of any excavated material which is required for use in refilling trench excavations, including any necessary double handling. Any excavated material not required for or not suitable for use as refilling shall be removed.

Trenches not to be left open:

Trench excavations shall be carried out expeditiously and, subject to any specific requirements of the contract, the refilling and surface restoration of trench excavations shall be commenced and completed as soon as reasonably practicable after the pipes have been laid and joined.

Refilling trenches:

With a view to restrict the length of open trenches, on completion of the pipe laying operations, refilling of trenches shall be started immediately by the contractor. Pipe laying and testing shall follow closely upon the progress of trench excavation and the contractor shall not permit unreasonable excessive lengths of trench excavation to remain open while awaiting testing of the pipe line.

The trench shall be filled with excavated material above the top of pipe, back filling is to be done keeping at least 90 cm length of pipe open at the joints, for verification of joints for water tightness during testing.

Care shall be taken while back filling, not to injure or disturb the pipe. Filling shall be carried out simultaneously on both the sides of the pipes so that unequal pressure does not occur. Walking or working on the completed pipelines shall not be permitted unless the trench has been filled to a height of at least 30cms over the top of the pipe except as may be necessary for tamping etc. during back filling work.

Filling-in shall be done in layers not exceeding 230mm in thickness accompanied by adequate watering, ramming etc. so as to get good compaction. The trench shall be refilled so as to build up to the original ground level, keeping due allowance for subsequent settlement likely to take place. Before and during the back filling of the trench, precautions shall be taken against the floatation of the pipeline due to the entry of large quantities of water into the trench causing an uplift of the empty or the partly filled pipeline.

Measurement:

The laying of sewers (RCC / stoneware) shall be measured from inside of the first manhole to the inside of the adjoining manhole. The manholes are measured from the invert of the manhole to the ground level as the depth of manhole.

10. LAYING & JOINTING OF STONEWARE PIPES:

The laying, jointing & testing of stoneware pipes shall conform to BIS code. Before laying the pipes, the contractor shall carefully brush them to remove any soil, stones, or other materials which may be therein, even and regular bed having been prepared and joint pit excavated to form a recess under the socket of each pipe of greater width and depth than to enable the pipe jointing to be properly done. Each pipe shall then be carefully lowered and placed singly in the trench and shall rest on the solid ground for a distance of not less than two thirds of its entire length.

Each pipe shall be brought into a true line from manhole to manhole. For this purpose, a strong twine line (rat thread) sufficiently long to reach the full length between manholes shall be used. Each pipe shall be set correctly to level by means of the boning rod and sight rails.

The pipe shall be laid according to the invert levels provided for the sewer line, true to line and gradient. Any variation in levels during execution or any other revision in design, if found necessary shall be carried out by tenderer without any extra cost.

The spigot of each pipe shall be carefully wrapped with a ring of tarred spun yarn dipped in cement grout gasket sufficiently thick to properly fit the socket of the adjoining pipe and to allow true alignment. The pipe shall then be driven fully home into the socket of the adjacent previously laid pipe and yarn or tarred gasket carefully driven home with a caulking tool.

The remaining space in the socket shall then be tightly and completely filled with cement mortar composed of one part of Sulfate resisting Portland cement and one and a half parts sand and shall be neatly beveled off all round the circumference and finished at an angle of 45 degrees outside the socket of the pipes. A wooden caulking tool shall be used for forcing the mortar into the sockets.

A tightly fitting bag of shavings or straw having a rope attached shall be drawn through the pipes as the work proceed to ensure that there is no cement or yarn or other obstruction projecting into the interior. All joints shall be kept moist either by means of wet bags, wet clay or wet earth whichever may be ordered by the engineer to protect them from the sun. Such covering shall be removed when the length is tested for water tightness.

Laying of stone ware / RCC pipes on rocky strata:

In trenches where the soil is rocky & slushy or at road crossings, socket and spigot stone ware pipes / RCC pipes are to be laid on sand bed & the method to be adopted is as follows:

When the earth is taken out to the proper depth and gradient, bedding of suitable thickness is to be laid as directed by the Engineer. The top of this bedding shall also be to the required gradient and to the required hydraulic level.

In case concrete bedding is necessary in shallow trenches of rocky, slushy or road crossings M15 concrete at the bottom and all around the pipe shall be carried out, keeping the hydraulic level as per the approved drawings.

Junctions on stoneware pipes:

Where shown on the drawings or where directed by the engineer junction pipes shall be provided at intervals during the construction of sewers, the jointing being effected in a similar manner to the pipes of the sewer in which they are placed. These junction arms shall be closed with stoneware or cement discs and the sockets filled with cement mortar. The trench shall not be filled in until the position and orientation of each junction has been measured and recorded by the engineer.

Laying & jointing of RCC pipes:

The laying & jointing of RCC pipes shall be done as per IS 783. The laying of RCC pipes between the manholes is similar to the procedure adopted for laying of stoneware pipes, perfectly true both in alignment and gradient on specified bedding. The pipe shall be laid according to the invert levels provided for the sewer line. Any variation in levels during execution or any other revision in design, if found necessary shall be carried out by tenderer without any extra cost.

After jointing, extraneous materials, if any, shall be removed from the inside of the pipe and the newly made joints shall be thoroughly cured. Rubber sealing rings conforming to IS:5382 are used for jointing the pipes.

Cleaning of pipes:

As soon as stretch of RCC pipes has been laid complete from manhole to manhole or for a stretch as directed by owner/engineer, contractor shall run through the pipes both backwards and forwards a double disc or solid or closed cylinder 75mm less in diameter than the internal diameter of pipes. The open end of an incomplete stretch of pipe line shall be securely closed as may be directed by owner/engineer to prevent entry of mud or silt etc.

If as a result of the removal of any obstructions owner/engineer consider that damages may have been caused to the pipe lines, he shall be entitled to order the stretch to be tested immediately. Should such test prove unsatisfactory, contractor shall amend the work and carry out such further tests as are required by owner/engineer.

It shall also be ascertained by contractor that each stretch from manhole to manhole or the stretch as directed by engineer is absolutely clear and without any obstruction by means of visual examination of the interior of the pipe line suitably enlightened by projected sunlight or otherwise.

Cleaning out sewers and manholes:

During the whole of the work the contractor shall keep interior surface of sewers and manholes free from cement mortar, bricks, soil or other superfluous matter and shall handover the sewers perfectly clean and free from deposit on completion.

Rubber Ring Joints:

The RCC pipes shall be of spigot & socket type with rubber ring joints. In the case of rubber ring joints the groove and the socket shall be thoroughly cleaned before inserting the rubber gasket. While inserting the gasket it shall be made sure that it faces the proper direction and that, it is correctly seated in the groove. After cleaning dirt or foreign materials from the plain end, lubricant shall be applied in accordance with the pipe manufacturer's recommendations.

The contractor shall make sure that the plain end is beveled as square or sharp edged may damage or dislodge the gasket and cause a leak. When the pipe is cut at site, the plain end shall be beveled with a heavy file or grinder to remove all sharp edges.

The RCC pipes with the rubber ring accurately positioned on the spigot shall be pushed well home in to the socket of the previously laid pipe by means of uniformly applied pressure with the aid of a jack or similar appliance. The plain end of the pipe shall be pushed into the socket of the pipe, and while pushing, the pipe shall be kept straight. If any deflections are to be made in the alignment, it may be made after the joint is assembled. A timber header shall be used between the pipe and crow bar or jack to avoid damage to the pipe while the plain end of the pipe is pushed into the socket either with a crow bar or jack, or lever puller.

Rider sewer:

Rider sewers of 200mm dia SW pipes are provided on both sides of the road where the road width is more than 30m and house service connections are connected to the rider sewer. The rider sewers are connected to the main sewers at intervals wherever required as per site condition or as directed by the Engineer in-charge. Manholes are also provided in rider sewers at 30m intervals. The procedure for laying & jointing of rider sewers are as per for stoneware pipes for sewer lines.

11. TESTING OF STONEWARE & RCC PIPES:

All sewers shall be tested before the filling in of the trench or other excavations. Testing shall also be done after refilling of the trench or other excavations, if considered necessary by the engineer. The testing or re-testing shall be carried out by and at the expense of the contractors who shall also provide the necessary appliances and water for the same. The tests will only be made from manhole to manhole after the manholes connected with the length under test have been completely finished.

The test shall be carried out in the following manner. The pipes shall be carefully cleared of all earth or materials that may be lying thereon or therein and all joints shall be exposed right round so that through examination may be made whilst the pipes are under test.

The ends of the pipe shall be closed by means of expanding stoppers and all junctions with stoneware stoppers or cement disc fixed in cement mortar.

The last but one pipe at the higher end of the length shall be a junction pipe with the junction arm at the top which will permit of the filling of the length with water and also allow the escape of all air in the pipes.

The expanding stoppers at each end of the length under test shall have a hold in the center with a small piece of a pipe screwed therein and threaded on the projecting piece to permit of a flexible tube not less than 2m long fixed thereto by a coupling. At the end of the flexible tubing, the following shall be fixed.

- a) at lower end of length, a clock.
- b) at top end of length, a funnel of 15cm diameter.

The top of the funnel shall be fixed rigidly at a height of 30cm above the ground level, or such other height as may be decided by the engineer.

After the above mentioned expanding stoppers have been fixed together with flexible tubing and funnel, the length shall then be filled with water through the junction arm of the pipe provided therefore. As soon as the water has risen to the level of the filling junction arm an expanding stopper shall be fixed thereon. After a short time has been allowed for absorption, water shall be poured into the funnel until the same is filled to the top.

If any of joints are leaking & if during a period of ten minutes the water level in the funnel drops 25mm or more (no more water being added or sewer interfered with in anyway during the period) the test shall be considered unsatisfactory. If the water does not drop more than 25mm and there is no sign of leakage at any of the joints, the test shall be continued for one hour and at the end of the hour the pipe lines including the joints shall be examined and if no indication of sweating or leakage is found then the test will be considered satisfactory. Should the test be unsatisfactory, all such joints or pipes found to be defective shall be removed, replaced or re-laid to the satisfaction of the engineer by the contractor at his cost.

The test shall be done as many time as may be necessary until the length is found to be watertight to the satisfaction of the engineer.

The water required for testing shall be clean. In case of testing of cement concrete sewer pipes of more than 600mm diameter, the permissible quantity of water replenished can be increased by 10% for each additional 100mm dia of pipe.

12. SEWER APPURTENANCES:

Manholes:

Manholes shall be constructed on the sewers in the positions shown in the drawings or in such position as the engineer may direct. The work shall be done strictly in accordance with the detailed drawings except where alterations are required by the engineer. Any variation in locating the manholes and subsequent revision in levels during execution if found necessary, shall be carried out by the tenderer at his cost. The excavation shall not be larger than sufficient to admit the trench being properly timbered and to facilitate plastering outside. The bottom of the excavation shall be properly levelled up, rammed and a bed of concrete laid thereon. When the concrete has sufficiently set all stoneware pipe connections through the walls shall be made and all ironwork fixed in as constructions proceeds. Sulfate resisting Portland cement shall be used for construction of manholes. Manholes up to 2.5m from invert of sewer to ground level shall be built rectangular and shall have a flat top constructed as shown in the drawings, manholes more than 2.5m from surface to invert shall be built circular and the walls corbelled as shown in the drawings. Manholes shall be constructed of best country bricks kiln burnt of size 8-3/4 x 4-1/4 x 2-1/4. The inside of all manholes shall be plastered with cement mortar 1:3, 20mm thick and the outside of all manholes with cement mortar 1:3, 12mm thick. The manhole bottoms shall be properly formed with channels fixed in cement mortar. The channels shall be neatly formed to the radius of the pipe and all side connection curved and channeled to admit the sewage to enter at an angle of 45° to the line of flow. Manholes shall be topped with a circular FRC frame cover conforming to IS 12592 part 1, heavy duty 600mm dia. The manhole frame shall be fixed to the top of the brickwork by a layer of cement mortar.

Where pipes pass through walls of manholes relieving arches shall be turned neatly over the upper half of the pipes. If any pipe enters at such an angle that a relieving arch cannot be properly turned the bricks shall be carefully cut and laid so as to fit closely and neatly against the pipe and a R.C.C. lintel shall be provided to avoid load of the walls being transmitted to the pipes. Plastic encapsulated steps shall be built in each manhole as the work proceeds one being inserted to every four courses of brick work, horizontal distance center to center of each row being 300mm. The contractor shall include in his prices for completing all manholes in accordance with the drawings.

13. APPLICABLE CODES:

The providing, laying & jointing at work sites of stoneware RCC, CI, PSC pipes & fittings shall comply with all currently applicable statutes, standards & codes. In particular, the following standards unless otherwise specified herein shall be referred. In all cases, the latest revision of the codes shall be referred to. If requirements of this specification conflict with the requirements of the codes and standards this specification shall be covered.

| | | | |
|----|---|------|--|
| IS | : | 458 | Specification for precast concrete pipe (with & without reinforcement) |
| IS | : | 782 | Specification for caulking lead |
| IS | : | 783 | Code of practice for laying of concrete pipes |
| IS | : | 784 | Code of practice for pre-stressed concrete pipes |
| IS | : | 1536 | Specification for centrifugally cast (spun) Iron pressure pipes for water, gas and sewage. |
| IS | : | 1538 | Specification for cast iron fittings for pressure pipes for water, gas and sewage |
| IS | : | 3114 | Code of practice for laying of cast iron pipes. |
| IS | : | 3597 | Method of tests for concrete pipes |
| IS | : | 5382 | Specification for rubber sealing rings for gas mains, water mains and |
| IS | : | 6587 | Specification for Spun hemp yarn |
| IS | : | 8329 | Specification for centrifugally cast (spun) Ductile Iron pressure pipes for water, gas and sewage. |

VI. PIPE LAYING WORKS

1 General

1.1 The earthwork for the pipe laying work shall generally conform to the invert level given in the drawing

a. Wherever necessary, sand cushioning for the bed shall be given as per IS Standards and as directed by the Engineer in charge. The pipe should be laid true to the alignment line and grade. Wherever necessary, appropriate bends should be used. The pipes laid must be jointed properly and carefully by using approved type of jointing materials.

b. After the pipes are laid and jointed, the pipelines are to be subjected to hydraulic pressure test as detailed in the relevant BIS Specification for various types as indicated below.

| | | | |
|----------------------|--------|-------|--------------|
| Cast iron Pipes.. | Clause | of IS | 1536 / 2001 |
| Ductile iron Pipes.. | Clause | of IS | 9523 / 2000 |
| PVC Pipes.. | Clause | of IS | 4985 / 2000 |
| UPVC pipes | Clause | of IS | 15328 / 2003 |

In portion of pipeline, where the pipes have developed cracks or sweating, such pipes with jointing materials shall be removed and re-laid with new pipes at the contractor's cost and the pipe line shall be re tested to the entire satisfaction of the Engineer in charge. No extra payment will be made on this account. The bidder has to make his own arrangements for the procurement of the required equipment for testing of pipes which shall be subjected to such test as the Engineer-in-charge deems fit to ensure the accuracy of the gauge.

c. Refilling shall be done with proper compaction with excavated earth. In no case the contractor shall be allowed to refill the trenches in hard excavated portion to be refilled by the boulders or excavated stuffs. This portion of trench shall be refilled by the soft strata from excavated stuff from distance place at no extra cost. The refilling shall be done in 15 cm thick layers duly watering and compacting each layer. The refilling may be done up to a height of 20 to 30 cm than the natural ground level to allow that sinking afterwards. If the refilling gets sunk below the natural ground level at any time till the completion of the work, the contractor at his cost should make good the refilling to the required level as may be directed by the Engineer in charge.

d. In case of pipe trenches, the Engineer may reduce the width of trench wherever hard strata is met with, if he feels adequate and just sufficient to lay the pipe line in order to reduce the hard rock quantity. In such case the contractor will be paid as per the actual measurement.

e. If the work is in a residential area, the contractor should carry out the excavation carefully to avoid collapse of any structure.

f. Valves shall be provided with valve pits with proper cover to bear the loads coming on it as per bid documents and departmental drawings and specification.

g. Adequate protective measures should be taken against surge pressure. Zero velocity valves and air cushion valves should be provided at the appropriate places. Thrust blocks and anchor blocks should be provided at all bends and appropriate places.

h. Water required for testing the pipeline shall be arranged by the contractor at his cost.

2 Laying of Cast Iron Pipes / Ductile Iron Pipes

2.1.

a. The laying and jointing of cast iron pipes shall be carried out as follows:

Before laying the pipes, the contractor shall carefully brush them to remove any soil, stones or other materials which may be therein. An even and regular bed having been prepared and joint pit excavated to form a recess under the socket of each pipe of no greater depth and width than to enable the pipe jointing to be properly done. Each pipe shall then be carefully lowered and placed singly in the trench and shall rest in the solid ground for a distance of not less than two thirds of its entire length. In places where the soil is not hard, cement concrete bed blocks or timber piles have to be provided under the pipes if directed by the Engineer in charge.

b. Pipes not Truly Laid

Any pipe or pipes laid, which on inspection are found to diverge from the true lines and levels shall be removed and re-laid to the true lines and levels and the old jointing properly cleared off the pipes and fresh joints made by the contractor at his expense. Any pipes damaged in removal shall be replaced by the contractor at his cost.

c. Cutting of C.I. / D.I Pipes

Where necessary and as ordered by the Engineer in charge, the Contractor shall cut the pipes and fix and joint common collars for jointing spigot ends. The cut ends of the pipe shall be made truly at right angles with the axis of the pipe.

d. Covering up Open Ends

The Contractor shall take particular care to ensure that the apertures and open ends of pipes are carefully covered whenever the workmen are not actually employed therein.

e. Jointing of C.I./ D.I Pipes

The trench must be kept quite dry during jointing unless in any particular case the Engineer permits laying of the pipe in wet conditions. Plain spigot and socket pipes shall be joined as follows.

f. Lead Joints

Generally, lead joints shall be used for all sizes. In the case of 100 mm pipes, cement joints may be used if specified in which case for every ten cement joints, one lead joint shall be used. Provision of lead joints shall also be made at street crossings, at closing joints and for all specials and as determined by the Engineer depending upon the site condition.

The spigot of the pipe must be forced well home into its socket and must be centered, so that the joint may be of even thickness all round. As many laps of white hemp spun yarn as may be needed to leave the space required for the lead shall be driven to the bottom of the socket without being forced through the joint into the pipe but carefully driven home with a caulking tool. The proper depth of each joint shall be tested before running the lead by passing completely round it a wooden gauge, notched out to the correct depth of lead, the notch being held close against the face of the socket. The joints shall then be run with molten lead insufficient quantity so that after being caulked solid, the lead may project 3 mm beyond the face of the socket against the outside of the spigot but must be flush with outside edge of the socket.

For pouring lead in the joints, a ring of hemp rope covered with clay shall be wrapped around the pipe at the end of the socket leaving an opening at the top of the socket into which the lead can be poured. The hemp rope shall be supported by clay packing so as to withstand the operation of lead pouring.

The lead used shall be carefully skimmed of all scale, when melted in a cast iron pot or patent melting machine. Sufficient lead shall then be taken by a ladle and run hot into the joint, and the joint filled at one running. The joint shall then be caulked when cool by a suitable caulking tool and a 2 kg hammer and the joint left neat and smooth.

The weight of lead and hemp which shall be used in each joint shall be in conformity with the table given below or as specified by the Engineer.

Quantity of lead and spun yarn for different sizes of pipes

| Nominal size of pipe (in mm) | Lead / Joint (in Kg.) | Depth of Lead joint (in mm) | Spun yarn per joint (in Kg.) |
|------------------------------|-----------------------|-----------------------------|------------------------------|
| 80 | 1.8 | 45 | 0.10 |
| 100 | 2.2 | 45 | 0.18 |
| 125 | 2.6 | 45 | 0.20 |
| 150 | 3.4 | 50 | 0.20 |
| 200 | 5.0 | 50 | 0.30 |
| 250 | 6.1 | 50 | 0.35 |
| 300 | 7.2 | 55 | 0.48 |
| 350 | 8.4 | 55 | 0.60 |
| 400 | 9.5 | 55 | 0.75 |
| 450 | 14.0 | 55 | 0.95 |
| 500 | 15.0 | 60 | 1.00 |
| 600 | 19.0 | 60 | 1.20 |
| 700 | 22.0 | 60 | 1.35 |
| 750 | 25.0 | 60 | 1.45 |
| 800 | 31.5 | 65 | 1.53 |
| 900 | 35.0 | 65 | 1.88 |
| 1000 | 41.0 | 65 | 2.05 |
| 1100 | 46.0 | 65 | 2.40 |
| 1200 | 50.0 | 70 | 2.60 |
| 1500 | 66.5 | 75 | 2.80 |
| 8 Inches | 4.54 | 2.00 Inches | 0.29 |
| 9 " | 5.10 | 2.00 " | 0.31 |
| 10" | 5.67 | 2.00 " | 0.34 |
| 12 " | 6.58 | 2.00 " | 0.48 |
| 14 " | 9.30 | 2.50 " | 0.63 |
| 15 " | 9.98 | 2.50 " | 0.68 |
| 16 " | 10.66 | 2.50 " | 0.74 |
| 18 " | 14.06 | 2.50 " | 0.95 |
| 20 " | 16.33 | 2.50 " | 1.04 |
| 21 " | 17.92 | 2.50 " | 1.08 |
| 24 " | 20.41 | 2.50 " | 1.21 |
| 27 " | 23.13 | 2.50 " | 1.33 |
| 30 " | 25.86 | 2.50 " | 1.46 |
| 33 " | 28.35 | 2.50 " | 1.65 |
| 36 " | 31.58 | 2.50 " | 2.40 |

Note:

The quantities of lead and spun yarn given in the table are provisions and variation of 20 percent is permissible.

g). Flanged Joints

Flanged joint should be made by painting the facing of the flange with white lead freely and bolting up evenly on all sides. A thin fibre of lead wool may be very useful in making the joints water tight where facing of the pipes is not true.

When packing must be used, it should be of rubber insertion of approved thickness. The packing should be of the full diameter of the flange with proper pipe hole and bolt holes cut out evenly on both the inner and outer edges. Where the flange is not fully faced, the packing may be of the diameter of the packing strip only. Proper placing of the packing should be checked before another pipe is joined on.

h). Cement Joints

The cement for the joints shall conform to IS 269 / 1989 specification for ordinary, rapid hardening and low heat Portland cement.

Cement and water taken in proportion 8:1 by weight shall be thoroughly mixed. The mixture shall be such that when it is tightly compressed by hand into a ball and the ball is broken into two pieces the break shall be clean. If the hand becomes water stained, it has to be considered that the water is excessive. If there is evidence of crumbling in the break, water added is less than required. The cement mixture shall ring with metallic sound while caulked.

Cement which has been wet for more than one hour or which has undergone initial set shall not be used for jointing.

i). Making the joints

When new pipes are laid close ahead of a newly made cement joint, the disturbance caused during the forcing home of the pipe ends into the sockets during the adjustment of the pipe to proper alignment may damage the new joint. To avoid this damage, jointing shall be done only when there are at least six pipes laid to the final grade and alignment ahead of the joint to be made. Starting at the bottom of the joint space shall be filled with wetted cement and caulked. The remaining joint space shall than be refilled with cement and caulked until the joint is practically flush with the face of the socket. The mixture shall be thoroughly compacted to make a water tight joint.

No water shall be allowed to touch the joint until the initial set had taken place. Immediately after initial set has taken place, the joint shall be covered with wet burlap, or other approved wet materials to ensure complete hydration of the cement. No water shall be allowed into the pipe until the elapse of 12 hours after the last joint in the line is made. Filling the pipe with water without pressure after this interval will be beneficial to curing of the joint.

j). Rubber Ring Joints

In the case of rubber ring joints or push on joints, the groove and the socket shall be thoroughly cleaned before inserting the rubber gasket. While inserting the gasket it shall be made sure that it faces the proper direction and that it is correctly seated in the groove. After cleaning dirt or foreign materials from the plain end, lubricant shall be applied in accordance with the pipe manufacturer's recommendations.

The Contractor shall make sure that the plain end is beveled as square as sharp edges may damage or dislodge the gasket and cause a leak. When the pipe is cut at site, the plain end shall be beveled with a heavy file or grinder to remove all sharp edges.

The plain end of the pipe shall be pushed into the socket of the pipe and while pushing, the pipe shall be kept straight. If any deflections are to be made in the alignment, it may be made after the joint is assembled. A timber header shall be used between the pipe and crow bar or jack to avoid damage to the pipe while the plain end of the pipe is pushed into the socket either with a crow bar or jack, or lever puller.

k). Fixing Sluice Valve

The sluice valves to be fixed on the pipelines shall be examined, cleaned and placed in the positions as shown in the drawings. The valves shall be placed on the pipeline and valve chambers constructed according to drawings. The depth at which the valve is to be laid and the dimensions of concrete and masonry shall be varied when necessary under the orders of the Engineer.

As the pipes in some instances may be required to be fixed at a less depth than will permit the top of the valve spindle being below the level of the road (but this may only be in cases where the position of the valve is to one side of the metalloid road) the walls of the valve chamber shall in such cases be carried up to such height at may be ordered, and the chamber shall have such covering as the Engineer may direct.

The valve shall be supported in the valve chamber so that no stress or strain occurs in the flange or other joints of the valve.

The valve shall be carefully protected from slime or dust by a suitable mat or gunny covering and the pit itself shall be cleared of all unwanted material.

l). Fixing Scour Valve

Scour valves shall be fixed at places shown in the drawings or as directed by the Engineer, and the scour connections from the main shall be carried out completely as per drawings.

m). Fixing Air Valve

Air valves shall be fixed at the summits of pipe lines or at places as may be directed by the Engineer. The air valve connections etc., shall be carried out as per drawing.

n). Interconnection Work

The Interconnection Work between the existing main and proposed main to be laid under this contract shall proceed from the new main to the existing main. Before actually proceeding with the interconnection work, the Contractor shall make ready necessary tools and plants required for the work at site, such as pump sets, shoring materials etc., He shall also keep ready at site necessary pipes, specials, valves if any required for the work. The Contractor shall keep necessary skilled workmen of sufficient strength at site and once the work is commenced, the entire interconnection works shall proceed without interruption by engaging labour for carrying out the work on a continuous basis both day and night till the work is completed. The work shall be executed as per programme drawn up by the Engineer and shall be completed within the time ordered by the Engineer, for each individual linter connection. The work shall be carried out under the direction of the Engineer from the beginning to end.

Laying of Specials, valves (except straight pipes from the branch of the new main to the connecting point in the existing main) including conveying specials etc., from the stores or site of stacking, excavation, timbering, pumping out water from the trenches, lowering, aligning, jointing specials and valves cutting the existing mains, baling out water, inserting the necessary branches, jointing, testing, refilling etc., shall comprise as one unit of work and will be paid at the lump sum rate quoted in the schedule for interconnections.

o). Works to be left Water tight

The Contractor shall construct the pipes chambers and all other Works so that they shall be water tight. Should any leakage appear, it shall be made good by him at his expense by removing and reconstructing the portions of the Work so affected or by other method which will render the Work thoroughly water tight to the satisfaction of the Engineer.

2.2. Cleaning of Mains

During the execution of the work the contractor shall keep the interior surface of the mains free from cement, brick, soil or other superfluous matter and shall hand over the mains perfectly clean and free from deposit on completion.

2.3. Masonry Chambers

Chambers for sluice valves, inspection, scour valves, air valves shall be constructed on the pipes in the positions as shown in the drawings or in such positions as the Engineer may direct. The work shall be done strictly in accordance with the detailed drawings or as ordered by the Engineer. The excavation shall not be made lower than necessary to admit of the earth being properly timbered. The bottom of the excavation shall be properly levelled, rammed and a bed of concrete laid thereon. When the concrete has sufficiently set the building of the brick walls shall then be proceeded with and all iron work fixed in as the building proceeds. The inside of all chambers shall be plastered with cement mortar 20 mm thick and the outside with cement mortar 12mm thick. The chamber shall be topped with pre-cast R.C.C. Slab 1:2:4 or cast iron surface box of valve cover as ordered by the Engineer. The surface box or valve cover shall be fixed on the top of the R.C.C. slab by a layer of; cement mortar and sides of the surface box or valve cover covered over with cement concrete.

Where pipes pass through walls of chambers relieving arches shall be turned neatly over the upper half of the pipes or R.C.C. lintels shall be provided to avoid load of the walls transmitted to the pipes.

Cast Iron steps shall be built in each chamber as the Work proceeds on being inserted to every 4 courses of brick work, horizontal distance center to center of each row being 30 cms.

The Contractor shall include in his rate for brick work cost for fixing steps, frame, cover etc., for completing all chambers in accordance with the drawings and with the above specifications.

2.4. Testing of Main-Hydrostatic Test

After laying and jointing the pipes and specials, the pipe lines shall be tested for hydrostatic pressure in such length as may be specified by the Engineer.

The test pressure shall be equal to 50% or such other higher percent as may be specified in excess of the pressure the pipe will have to withstand subsequently subject to a minimum test pressure of 7 kg/sq.cm. in the case of lead joints. However, in the case of cement joints, the joints may be tested to a minimum test pressure 3.5 kg/sq.cm.

If cement joints show seepage or slight leakage, such joints shall be cut out and replaced as directed by the Engineer and the test repeated.

The contractor shall make his own arrangements to procure, necessary equipment, apparatus etc., required for testing and shall provide necessary labour for filling with water the length of pipes to be tested, fixing all apparatus and for carrying on the testing operations until the length of pipes specials and connections are finally passed by the Engineer.

The length to be tested shall be provided with two blank flanges fastened on in the usual manner by collar bands and bolts to the end pipes or if the length to be tested shall have a sluice valve at each end, such blank flanges may be dispensed with.

The length of pipes to be tested shall first be filled in with water from a higher section of pipes already laid or with clean water shall be arranged at the contractor's expense with the approval of the Engineer.

Before the actual testing pressure is applied any air which has lodged in the length of pipes to be tested shall be got rid of, by screwing on at the highest part of the length of pipes or temporary air valve, or, by opening a temporary stop-cock or by other mean as the Engineer may direct.

The test pressure shall then be applied to the length of pipes under test by a hand or powered hydraulic test pump. The connection of the test pump to the length of pipes shall either be at the union connection provided at a blank flange or shall be at a temporary stop cock or fountain connections as the Engineer may in the circumstances direct.

The actual test shall be made by pumping water into the length of pipes under test, until the test pressure as specified above has been reached on the pressure gauge.

The test pressure shall be maintained for one hour or for such other period of time as may set by the Engineer and each joint will be inspected. While the pressure is on, the pipes should be struck smartly with a 2 kg hammer.

When a flange joint is found to be leaking, care shall be taken that while tightening up the flanges, the neighboring joints are not affected.

If the length of pipe line under test is found to be satisfactory and no leaks or sweatiness are found at the pipe joints or at the joints of specials and connections, then this length of pipe line will be passed by the Engineer.

But should any pipe, joint, special or connection be found to sweat or leak, the contractor shall make good at his cost such defective joint and the length of pipe line shall be re tested by the Engineer until all pipes, joints, specials and connection are found to be satisfactory.

If any pipe or special leaks or bursts, the damaged portion shall be removed and new pipes or specials shall be laid and jointed at the contractor's cost.

2.5. Collection of Rubbish

The Contractor shall, at his cost on the completion of the Work remove all water and all materials or rubbish of every description which may have been collected in the works find a deposit thereof and anything which may have collected within the works during the period of maintenance shall also be removed before the Works are finally accepted by the Employer.

3. Laying and Jointing of Asbestos Cement Pressure Pipes

Not applicable

4. Laying and Jointing of PVC Pipes

a). Laying of PVC Pipes (IS 4985/2000)

The trench bottom should be carefully examined and should be free from hard objects, such as flints, rock projections or tree roots etc. The bedding for the pipes should be brought to an even finish providing uniform support for the pipes over their length and pipes laid directly on the trench bottom. In other case the trench should be cut correspondingly deeper and the pipes laid on a prepared under bedding which may be drawn from the excavated material if suitable. As a rule trenching should not be carried out too far ahead of pipe laying. The trench should be kept as narrow as practicable but must allow adequate room for jointing pipes and placing and compacting the back fill. Mains should be laid with a cover of not less than 1 m measured from the top pipes to the surface of the ground. Mains which might be brought under roadways by future widening schemes should be so laid that the eventual will not be less than 1 m.

b). Jointing of PVC Pipes

The jointing of PVC pipes is done either by using Solvent Cement Joint or rubber ring joint.

The solvent cement used for jointing should be of the quality as specified in IS 14182/1994. The spigot and socket ends of the pipes should be cleaned and roughened with emery paper. If the ends are grossly contaminated, they should be cleaned with Acetones or Methyl Alcohol. The solvent cement should be thickly applied on the spigot end and thinly in the socket. For larger sizes the first coat should be allowed to dry and a second coat applied. The spigot is then pushed into the socket and the excess cement wiped off at once with a piece of cloth or rag. The joint should not be disturbed for at least 5 minutes. The pipes should not be subjected working pressure for 24 hours after jointing.

c). Rubber Ring Joint.

The pipes for rubber ring joints are supplied with both ends chamfered. A mark should be made at a distance from the pipe an end equal to half the length of the coupler. The inner side of the coupler ring and the chamfered end of the pipe should clean and dry. The 'O' ring is then slipped into the coupler. The ring and the chamfered end of the pipe are lubricated with a lubricant. The coupler and the pipe should be carefully aligned and should be truly coaxial. The coupler is then pushed home into the pipe or the pipe is pushed into the coupler to make the joint.

5. Laying and Jointing of RCC Pipes

The laying and jointing of RCC pipes shall be done as per IS 783 -- 1985 and testing will be done as prescribed in the relevant Indian Standards.

6. Disinfection of Mains.

Upon completion of a newly laid main or when repairs to an existing pipe are made, the main shall be disinfected as directed by the Engineer.

The mains shall be flushed prior to disinfection except when the tablet method is used. After initial flushing, the hypochlorite solution shall be applied to the water main with mechanically or electrically powered chemical feed pump designed for feeding chlorine solutions. For small applications, the solution may be fed with a hand pump.

In the case of mains of a large diameter, water from the existing distribution system or other approved source of supply shall be made to flow at a constant measured rate into the newly laid pipe line. The water shall receive a dose of chlorine also fed at a constant measured rate. The two rates shall be proportioned so that the concentration in the water entering the pipeline is maintained at not less than 300 mg/l. The chlorine shall be applied continuously and for a sufficient period to develop a solid column of 'Slug' of chlorinated water that will as it passes along the line expose all interior surfaces to a concentration of at least 300 mg/l. for at least 3 hours. As the chlorinated water flows past tees and crosses, related valves and hydrants shall be operated so as to disinfect the appurtenances.

After the applicable retention period, the heavily chlorinated water shall be flushed from the main until the chlorine concentration in the water leaving the mains is not higher than the generally prevailing in the system or less than 1 mg/l.

After final flushing and before the water main is placed in service, a sample or samples shall be collected from the end of the line and tested for bacteriological quality and shall show the absence of coliform organisms. If the initial disinfection fails to produce satisfactory samples, disinfection shall be repeated until satisfactory samples have been obtained. When the samples are satisfactory, the main shall be placed in service.

7) Laying and jointing of Ductile iron pipes.

a) Ductile iron pipes

The Ductile Iron pressure pipes shall conform to the I.S. 9523 /2000 & specials as per IS 8523/2000.

b) Laying Ductile Iron Pipes as per IS 12288/1987

The pipe should be lowered into the trench with tackle suitable for the weight of pipes. For smaller sizes up to 250mm nominal bore, the pipe may be lowered by the use of ropes but for heavier pipes either a well-designed set of shear legs or mobile crane should be used. When lifting gear is used the positioning of the slink to ensure a proper balance, should be checked when the pipe is just clear of the ground. If sheathed pipes are being laid, suitable wide slings are scissor dogs should be used.

All construction debris should be cleared from the inside of the pipe either before or just after a joint is made. This is done by passing a pull through in the pipe, or by hand, depending on the size of the pipe. When laying is not in progress a temporary end closer should be securely fitted to the open end of the pipe line. This may make the pipe buoyant in the event of the trench becoming flooded, in which case the pipe should be held down either by partial refilling of the trench or by temporary strutting. All persons should vacate any section of trench into which the pipe is being lowered.

b.1 On gradient of 1:15 or steeper, precautions should be taken to ensure that the spigot of the pipe being laid does not move into or out of the socket of the laid pipe during the jointing operations. As soon as the joint assembly has been completed, the pipe should be held firmly in position while the trench is back filled over the barrel of the pipe. The back fill should be well compacted.

c) Jointing of Ductile Iron Pipes:

Two main types of joints are used with Ductile Iron pipes and fittings.

- i) Socket and spigot flexible joints.
 - 1. Push on joints
 - 2. Mechanical joints
- ii) Rigid flanged joints.
- iii) Flexible joints:

The spigot and socket flexible joint should be designed to permit angular deflection in direction and axial movement to compensate for ground movement and thermal expansion and contraction. They incorporate gasket of electrometric materials and the joints may be of the simple push-on-type or the type where the seal is effected by the compression of a rubber gasket between a seating on the inside of the socket and the external surface of spigot. Joints of the latter type are referred to as mechanical joints. Both push-in and mechanical joints are flexible joints. Flexible joints require to be externally anchored at all changes in direction such as at bends, etc., and at blank end to resist the thrust created by internal pressure and to prevent the withdrawal of spigots.

(d) Flanged joints:

Flanged joints are made on pipes having machined flange at each end of pipe. The seal is usually effected by means of a flat rubber gasket compressed between two flanges by means of bolts which also serve to connect the pipe rigidly. Gaskets of other materials, both metallic and non-metallic are used for special applications.

e) Jointing procedure:

Procedure for jointing will vary according to the type of joint being used. Basic requirements for all types are:

- a) Cleanliness of all parts
- b) Correct location of components

- c) Centralization of spigot within socket and
- d) Strict compliance with manufacturer's jointing instructions.

The inside of sockets and the outside of spigots should be cleaned and wire brushed for a distance of 150 to 225 mm. Glands and gaskets should be wiped clean and inspected for damage. When lifting gear is used to place the pipe in the trench, it should also be used to assist in centralizing the spigot in the socket.

Where the pipeline is likely to be subjected to movement due to subsidence or temperature variations, the use of flexible joints is recommended. A gap should be left between the end of the spigot and the back of the socket to accommodate such movement.

8. HDPE PIPES

- 8.1 The HDPE pipe shall be made from base polymer and shall conform to the requirements as specified in MS 1058 Part I : 2002 and IS 4984.
- 8.2 The base polymer shall be a single grade of polyethylene, PE 100.
- 8.3 No rework material is allowable for the manufacture of the pipes.
- 8.4 No additives that may contribute to toxic hazard, impair the fabrication of properties and chemical and physical properties in particular to long term mechanical and strength is allowed.
- 8.5 The colour of the pipes shall be black with blue stripes.
- 8.6 The material for stripes shall be of the same type of resin as used in the compound for the pipe.
- 8.7 The required length of HDPE pipes in coil for nominal diameter up to 100mm and below shall be 100 meter.
- 8.8 The standard length of HDPE pipes for nominal diameter 125mm and above shall be 9m or 12m.
- 8.9 The internal and external surfaces of pipes must smooth, clean and free from scoring, cavities and other surface defects which may affect pipe performance.
- 8.10 The ends of pipe shall cut cleanly and square to the axis of the pipe. Appearance shall be checked at the point of manufacture.

VII. LIQUID RETAINING STRUCTURES

1. Wet Well shall be executed as per the drawings and specifications and as directed by the Engineer in charge.
2. The wet well shall be provided with suitable size D.I / D/F. Pipes for inlet and delivery connections and painted with two coats of anti-corrosive paint as per BOQ / Drawing.
3. Testing for Water Tightness:
 - 3.1 In case of wet well with top covered, the tanks shall be deemed to be water tight if the total drop in water level over a period of seven days does not exceed 40mm.
 - 3.2 If the structure does not satisfy the condition of the test period, the test may be extended for a further period of seven days and if the specified conditions of the test are satisfied the structures shall be considered to be water tight.
 - 3.3 In case of unsatisfactory test results, the contractor shall ascertain the cause, make all necessary repairs and repeat the procedure in the preceding clauses until the test has been passed satisfactorily at no extra cost to the Employer.

Steel reinforcement Shall comply with the relevant sections of;

| | | |
|------|--------------------------------|--|
| i. | IS: 1784 - 1986 | Specifications for pre-stressed concrete pipes |
| ii | IS: 1785/1983 (Part I & II) | Specifications for plain hard drawn steel wire for pre-stressed concrete |
| iii. | IS: 432 - 1982 | Specification for mild steel and medium tensile steel bars and hard drawn steel wire for concrete reinforcement |
| iv. | IS: 226 - 1975 | Specification for structural steel |
| v. | IS: 1139 - 1966 | Hard rolled mild steel for concrete reinforcement |
| vi. | IS: 1566 - 1982 | Specification for hard drawn steel wires |
| vii. | IS: 456 – 2000 | Code of practice for plain and reinforced cement concrete. |
| | Rubber jointing gaskets | The joint shall be sealed with a continuous ring gasket made of a special composition rubber of such size and cross section as to fill completely the recess provided for it. The gasket shall be the sole element depended upon to make the joint water tight and shall have smooth surfaces free from pits, blisters, porosity and other imperfections. The rubber compound shall contain not less than 5 percent by volume of first grade synthetic rubber. The remainder of the compound shall consist of pulverized fillers free from rubber substitutes, reclaimed rubber and deleterious substances. The compound shall meet the following physical requirements when tested in accordance with appropriate ASTM specifications of BV Class of BS 2494 Part I – 1955. |
| | | TENSILE STRENGTH |
| | | The tensile strength of the compound shall be at least 2,700 psi for natural rubber gaskets and 2300 psi for synthetic – rubber gaskets (method of test for tension of vulcanized rubber. ASTM designation D.412). |
| | | ELONGATION AT RUPTURE |
| | | The elongation at rupture shall be at least 400 per cent for natural rubber gaskets and 350 per cent for first grade synthetic rubber gaskets (method of test of tension testing of vulcanized rubber ASTM Designation D.412) |
| | | SPECIFIC GRAVITY |
| | | The specific gravity shall be consistent within 0.05 and within the range of 0.95 to 1.45 (methods for chemical analysis of rubber products “ASTM Designation B.297”. |

| | | |
|--|--|---|
| | | COLD FLOW |
| | | The percentage of cold flow shall not exceed 20. The cold flow determination shall be made in accordance with "Methods of Test for Compression Set of Vulcanized Rubber". Method – B (ASTM Designation D.395) with the exception that the disc shall be a 12 mm thick section of the rubber gaskets. |
| | | TENSILE STRENGTH AFTER AGING |
| | | The tensile strength of the compound, after being subjected to an accelerated aging test for 96 hours in air at 158 ^o F shall not be less than 80 percent of the tensile strength before aging "Method of Test for accelerated aging of Vulcanized rubber by the Oven Method" (ASTM Designation D.573) |

4. Designation of pipes and fittings:

4.1 Pipes and fittings will be classified according to their diameter, pressure head and they shall be marked as shown below:

- a. Name of manufacturer
- b. Date of manufacture
- c. Internal diameter of pipe
- d. Test pressure
- e. Permissible working head
- f. Effective length of the pipe
- g. Serial Number.

Recessed markings will not be permitted.

4.2 Whenever practicable, each rubber rings shall be plainly and clearly marked in a suitable position with

- a. Manufacturers name of trade marks
- b. Month and year of manufactured
- c. Class of ring
- d. Number of the British Standard, i.e. BSS 2494 – 1955. In case where marking of the actual rings is not practicable or is likely to be detrimental to their effective use, the rings shall be supplied, fastened together in parcel of suitable size, each bearing a label giving the above particulars.

VIII. ELECTRICAL WORKS AND PUMPING MACHINERY

A ELECTRICAL

1 General

Following clauses specify General Electrical requirements and standard of workmanship for the equipment and installations. General specification classes shall apply where appropriate except where particularly redefined in the Special Specification Clauses.

2 Standards

The equipment offered shall comply with the relevant Indian Standards. The equipment conforming to any other approved International Standards which is considered equivalent or superior shall be acceptable. The tenderer however, shall have to substantiate equivalence or superiority.

3 Requirement of Statutory Authorities

The electrical equipment/installations shall comply with the requirements of Rules/Regulation as amended up-to-date, required by Statutory Acts or Authorities.

- The Indian Electricity Rules, 1956
- The Indian Electricity Act.
- The Indian Electricity (Supply) Act, 1948
- The requirements of Chief Electrical Inspector to the Government of Odisha.
- The requirement of Odisha State Electricity Board.
- Fire advisory Committee Insurance Act.
- The contractor shall get the drawings, layouts of HT sub-station etc. approved from OWSSB and Electrical inspector of Govt. of Odisha, wherever, necessary. The contractor also shall arrange to get the installation inspected by CEIG and carryout modifications / rectification as required by CEIG, prior to commissioning of sub-station/electrical equipment.

4 H-Frame Steel Structure

H-frame galvanized steel self-supporting structure shall generally have the following equipment.

- Lightning Arresters
- Gang Operated A.B Switch
- DO Fuses
- String Insulators
- Pin Insulators
- ACSR conductors of appropriate sizes to connect all the equipment

4.1 Lightning Arrester

Lightning arresters shall be provided on each 11KV line before the termination on the 11KV isolators in the switch yard. Lightning Arresters shall be suitably mounted on H pole structure or 4 pole structure for receiving 11kv supply as per IS 3070 Part I.

4.2 Gang Operated AB Switch

The Switches shall be provided with horizontal connecting bar, for gang operation, G.I pipe as down rod lever coupling and operating handle with padlock and other components necessary for complete assembly.

4.3 11KV Drop-Out Fuses

The 11KV drop-out fit off fuses shall offer protection against short circuit and suitable for use in conjunction with 11KV system having fault level of 500 MVA as per relevant ISS.

A suitable insulated operating rod shall be provided with each fuse assembly. Two pairs of rubber hand gloves for working on 11KV shall be provided.

4.4 Insulators

The disc, pin and post type insulators used shall be of high quality glazed porcelain. The electrical and mechanical characteristics shall conform to IS:731 and IS:254. The insulators shall have following characteristics suitable for use in an effectively earthed system.

- System voltage : 11kv
- Dry Wet one- minute power Frequency to withstand voltage : 22 kv

- 1.2/50 micro second impulse withstand voltage : 75KV
- Power frequency puncture withstand test voltage on units : 1.3 times of the dry flash over voltage of the unit.
- Visible discharge voltage : 9 KV
- Total minimum creep age distance for post and disc insulator : 320 mm for post insulation
320 mm for disc insulation

5 HT Sub Station

5.1 In general HT sub-station shall be out door type. The transformer shall be suitable for outdoor type and installed on cement concrete platform, having capping level well above the flood level of that area. The size of the platform shall be decided by the contractor, depending on the capacity number of transfer to be installed. In case of indoor sub-station, the transformer shall be suitable of indoor type. The transformer HT/MV panel rooms shall be decided to suit requirement. The transformer may be erected on the structure also with suitable provision made in the H pole structure. Fencing shall be provided as per relevant IE rules.

6 Power Transformers

6.1 General

TRANSFORMER SHALL BE 22 KV /0. 433KV

Type: Outdoor in general. In case of indoor, sub-station shall be indoor type, mineral oil filed natural cooled ONAN as per standard IS 2026 with of circuit tap changer of + 5 to - 10% in steps of 2.5%. Adequate number of radiator elements made of low carbon sheet steel should be provided for cooling.

Technical Particulars:

No. of Winding: 2
No. of Phase: 3
Winding connection: primary – Delta Secondary - Star
Connection Symbol: DYN 11
Rated frequency: 50 Hz
Rated kVA: 400
Rated primary voltage: 11kV Short circuit level: 26.2kA
Method of system earthing: Solidly earthed
Rated Secondary voltage: 433 V Impedance voltage: 4%
The temperature rise at reference ambient as per IS: 2026
Top oil 45oC by thermometer method
Winding 55oC by resistance method
Primary and secondary side cable box for cable termination.
All standard fittings and accessories as per IS
Acceptable makes CGL, EMCO, Bharat Bijlee, WSON or equivalent

6.2 Insulating Oil

The transformer shall be supplied with insulating oil duly filled. The insulating oil shall conform to IS: 335 10% excess oil shall also be supplied to account for loss.

6.3 Transformer Accessories

The transformers shall have the following Accessories

- Off Circuit manual tap changing switch externally operated as specified and positioned on side of transformers accessible from the ground level;
- Conservator with drain plug, filling as specified.
- Explosion vent with diaphragm
- Air-relief vents;
- Inspection cover on the tank covers for all transformers;
- Filtering connections with required valves

7. Following valves shall be provided

- | | | |
|--------------------|---|---------|
| Oil sampling valve | - | One No |
| Oil Drain valve | - | One No |
| - Filtering valves | - | Two Nos |
- Grounding terminals, two for the transformers tank for clamping to purchaser's grounding grid connection;
 - Lifting lugs or eyes for the over top part of tanks, cores and coils, and for the complete transformers
 - Pulling eyes, for pulling the transformers parallel to and at right angles to the axis of bushings.
 - Diagram and rating plate for transformers,
 - Rollers
 - Thermometer pockets with dial type thermometers for top oil temperature indication. The thermometer shall be clearly visible from ground level as specified.
 - Weather proof control cabinet
 - Buchholz relay Transformer shall be tested as per IS 2026.

8 HT / LT Panel Board

PANEL BOARD:

Supply and delivery of floor mounting type weather vermin and dust proof powder coated LT cubical panel board of 14 SWG mild steel sheet and suitable steel angle frames with enclosed energy efficient Aluminum bus bar of electrolytic grade E91

PVC sleeved of suitable size for phase and neutral with hinged front door and railway type lock and key arrangements 4 Nos. of required current carrying capacity with all internal wiring as per IE rules and as per IS:8633 and as per CEIG's safety requirements. The design of panel board should facilitate for quick operation of all switches from the front side, and the panel board should be completed with all internal wiring including necessary twin copper earthing arrangements and consists of the components for controlling incoming and outgoing supply.

INCOMING:

a) 2 Nos. of 800 Amps. draw out type ACB with insulation voltage of 600 V. 50 KVA breaking capacity with under voltage release and with suitable current transformers, with over load relay. Each breaker shall be fitted with suitable size Ammeter, Voltmeter, Rotary selector switches, side lock fuses earth fault relay etc. pilot lamps and protection fuses for controlling the transformer secondary side.

OUTGOING:

b) 2 Nos. of 200 amps MCCB suitable to control outgoing supply to the motors with two locks and one key interlocking arrangements so as to feed only one of the Motors/Pumps with over current and short circuit releases to. Pump set vide SI No.1 a) through VFD

c) 2 Nos. of 100 amps MCCB suitable to control outgoing supply to the motors with two locks and one key interlocking arrangements so as to feed only one of the Motors/Pumps with over current and short circuit releases to Air Diffusers.

d) Appropriate nos. of 63 amps MCCB suitable to control outgoing supply to the motors with two locks and one key interlocking arrangements so as to feed only one of the Motors/Pumps with over current and short circuit releases to Pump sets.

e) Appropriate nos. of 32 amps MCCB suitable to control outgoing supply to the motors with two locks and one key interlocking arrangements so as to feed only one of the Motors/Pumps with over current and short circuit releases to Pump set / Motors through starter etc. complete.

f) 2 Nos 63 Amps MCB to control the lighting load.

The fuse switch should have appropriate nos. of suitable 300/5A current transformers for controlling the supply to the pump sets with mechanical interlocking arrangements on the outgoing side so as to make it possible to operate only one motor at a time with suitable Ammeter with suppressed scale with zero adjuster, selector switches etc. The meters should conform to IS 1245.

g) 144 mm Square type Ampere Digital Ammeter with phase selector switch & side lock fuses, one for the motor and other for capacitor bank in the outgoing feeder.

h) 144 mm Square type 0-500 V. Digital Volt Meter with phase selector switch & side lock fuses, one for the motor and other for capacitor bank in the outgoing feeder.

i) 3 phase & wire digital KWH meter for direct reading 3 phase CT operated digital energy meter suitable for the motor to monitor the specific energy consumption of each motor with IS mark as per IS :13010/89 and amended from time to time.

j) 144 mm Square type digital Power Factor Meter.

k) Appropriate nos. RYB & LED ON /OFF indicating lamps with control fuse/switch.

l) Suitable Current Transformer for the above metering.

m) Earth fault relay-1set

n) Vertical Three Phase Lighting Distribution Board with MCBS

12-way vertical TPMCB sheet steel distribution boards Flush type/Surface type fitted with bus bars and Neutral Links with three phase MCB outgoing and separate 4-way provision for accommodating one no.4-pole incoming MCB and another separate 4-way for accommodating one no.4 pole ELCB with label holder and provision for taking up cable for not less than 32 sq.mm.

Supply, erection on wall, testing, commissioning at site and handing-over in satisfactory working order of Lighting Distribution Board (LDB) 12 ways 3 Phase DB and as per feeder details given in single line diagram enclosed with technical specifications complete including all lead and lift and as directed by the OWSSB officers.

9 Air Circuit Breakers

The Air Circuit Breakers shall conform with IEC/Indian standards. The ACBs shall be manually draw out type in open execution with over current trip device adjustable 64% to 110% time setting for overload adjustable current setting for short circuit protection and adjustable current and time setting for earth fault protection.

| | |
|------------------------------------|---|
| No. of poles | - 4 or 3 |
| Rated insulation voltage | - 1000 |
| Rated short circuit breaking | - 50 KA – (AC – 415V) |
| Rated making capacity AC | - 105KA |
| Rated short time withstand current | - 50KA |
| Total making time | - 30 millisecond |
| Total Breaking time | - 38 ms. |
| Motorized mechanism | - 220/240V |
| Under voltage released AC | - 150/(66)VA |
| Opening line delay | - 20 – 30 MS |
| System protection | - overload, short circuit, Earth fault |
| Overload protection | - adjustable current settings variation 50% to 100% |
| Short circuit protection | - adjustable pickup level |
| Earth fault protection | - relay shall have sensitivity of adjustable Between 10% to 30% of ACB rating |

Air circuit Breaker shall be fitted with following

- Heavy duty switch having not less than 4 No. + 4 N C - contacts
- Built in resin cast current Transformer
- Auxiliary contacts
- Shunt and under voltage tripping device
- Neutral CT for earth fault protection
- ACB shall be suitable for locking the breaker in various positions. Provision of door locking with requisite end termination lug and sockets. Terminal bars for connecting more than one terminal.

10 Moulded case circuit breakers

The moulded case circuit Breakers shall have overload, and Short-circuit protective elements. The contact system shall be designed to have minimum wear and also energy loss. Arc extinguishing device shall be provided. The MCCB shall have 'ON' – 'OFF' or 'Trip' indicators. The interrupting capacity of the breaker shall be 35KA – 50 KA at 415V. The MCCB shall be tested as per IS 2516.

The container shall be of non-conducting materials and withstand high temperature, and flame retardant.

11 Miniature Circuit Breakers

Miniature circuit breaker working on residual current device having 6000A short circuit breaking capacity and 30 milli amp. sensitivity and 30 millisecond tripping time conforming to IS 12640 trip free mechanism operating for rated leakage at nominal 10 Volts. Earth leakage circuit breaker also may be provided wherever necessary instead of MCB.

11.1 Fuse Switch Units.

The fuse switch unit shall be suitable for 415/430V operation and conform to IS 13947 (Part 3) and IEC 947-3.

The switch shall conform to following Technical specification

| | |
|--|------------------------------|
| Rated operational voltage | - 415V |
| Rated insulation voltage | - 660V |
| Rated Thermal current | - 125A/160A/250/400A |
| Number of Poles | - Three (TPN) isolate |
| Rated operational current | - as required |
| Rated making capacity | - 10 times the rated current |
| Rated fuse short circuit breaking capacity at 415V | - 176 KA |
| Rated fuse short circuit withstand capacity | - 80 KA |

11.2 Indicating Instruments

All electrical indicating instruments shall be digital square type of size suitable to the panel. These shall be suitable for flush mounting with only flanges projecting on vertical panel. Instrument dial shall be white with black numerical lettering.

Instrument shall conform to IS 1248 and shall have accuracy class 1.00 or better. The current coil and potential coil of Ammeters and Voltmeters respectively, shall withstand 120% of rated current and voltage, without loss of accuracy.

The meters shall have external zero adjustments. The ammeters fitted in the motor circuits shall have suppressed scale to indicate the maximum starting current. The instrument shall be provided with glass cover to avoid the possibility of measurements due to static charge.

The three phase three wire trivector meter shall comprise of KWH meter and KVAH meter mounted together with KVAH meter in one case with special summator mounted between them to register correct KVAH at all power factors.

All the factors shall have respective maximum demand indicators to record the average power over a period of half an hour. The trivector meter shall conform to relevant IS.

11.3 Under Voltage Relays

The induction disc type, single pole under voltage relay shall have inverse time voltage characteristics on all taps. The relay shall be designed to develop maximum torque at supply frequency and shall be insensitive to the voltage at harmonic frequencies.

The operating time shall be adjustable by time setting multiplier. Selection of the required voltage setting shall be possible by means of a plug setting bridge having an insulated plug. The relay shall conform to IS-3231.

12 Protective Relays

Relays shall be rectangular in shape, flush mounting type, having dust tight covers, removable from front, and shall be equipped with externally reset, positive action operations indicators. The relay shall have auxiliary units of either series connected or shunt connected type. All auxiliary relays shall be non-draw out type and protection relays shall be draught type with test facilities.

Test plug shall be supplied loose. All relays shall conform to the requirements of IS - 323 or relevant IEC in general and IS - 3231 in specific.

Relays shall be provided with adequate number of potential free self-reset /hand reset output contacts as required. Provision shall be made for easy isolation of trip circuits of each relay for the purpose of testing and maintenance. Current transformer short circuiting arrangement shall be provided in case of draught type relays.

Voltage relays shall have sufficient thermal capacity for continuous energization using external resistance, if necessary.

No control relay, which will trip a circuit breaker when relay is de-energized, shall be used.

13 CABLES

13.1 1100V/660V Grade cables shall be PVC insulated, PVC sheathed, G1 strip armoured, Aluminum conductor.

The control cables and cables for lighting system shall be with PVC insulated, multi stranded copper conductors. Cables in general shall conform to IS 694, IS 1554, Part I & II, and cross section 25, 16, 10, 6, 4, 2.5 and 1.5 sq.mm.

13.2 Laying of cables

Cables shall be laid directly buried on earth, in conduits along walls, ceiling etc. The cable installation shall conform relevant ISS.

Cable inside the Sub-station/Building shall be laid in the prepared trench. If any hole or breaking of wall is required for cable laying work, it shall be done by the contractor and the wall shall be closed after completion of the work as original.

The cable trench dimensions inside the Sub-station and the route shall be indicated to the civil contractor well in advance while Sub-station civil work is in progress, depending upon the cable entry, and location of different equipment, transformers, panels, etc.

Laying of underground cables outside the building shall be done by excavating a trench covered by brick and sand of 0.75 metre depth for HT and LT cable and protecting each run of cable by sand and earth filling.

The HT and LT cables shall be taken through the cable duct provided on the ground floor roof as shown in the sketch, by properly clamping.

Fixing of cable on the wall by clamping the cable, using suitable GI clamps with wooden saddles. The distance between two clamps shall not be more than 750mm. The cables shall also be taken through PVC pipes on the wall. The cable route on the walls shall be decided with the Engineer in site. The cables shall be covered with GI plates, trays or wooden covering. Sharp bending, twisting and Kinking of cables shall be avoided. Suitable cable duct shall be provided in the wall connecting all switch rooms of Railways and Commercial Complex.

14. Distribution Boards

All the switch Boards, Panels shall be neatly wired using 1100/660V PVC insulated stranded copper cable of minimum 2.5 sq.mm. Copper Bus Bars also may be provided to suit the requirements.

Each wire shall be identified at both ends with cable marker.

Distribution Boards shall be housed in metal clad case or board conforming IS 4237. The sub-distribution boards shall be equipped with rigidly fixed miniature circuit breaker complying IS8828 in the phase leads with over load and short circuit protection. The MCBs shall have adequately sized terminals for the outgoing leads. The distribution boards shall have adequately rated phase and neutral bus bars of high conductivity copper. Earth bus bar with the necessary number of terminals for connecting the earth continuity conductors.

Each SDB shall have circuit schedule pasted or permanently fixed inside the cover stating the details of circuit controller and rating of MCB. Non-flammable insulating shields shall be provided to prevent fire hazards during operation of MCBs.

The Sub-Distribution Boards shall not be mounted at a height exceeding 180CM from ground level.

Main Distribution Boards shall be surface mounted. Main Distribution Boards shall be erected in each switching room, and sub-distribution boards shall be located according to the distribution of load and the equipment to be connected and its location.

15. Lighting System

15.1 Point Wiring

Point wiring shall include all work necessary to complete wiring from switch circuit of any length from the tapping point on the distribution circuit switchboard to the following:

- Ceiling rose for fans, lighting etc.
- Socket outlet (in the case of socket outlet points)
- Lamp holder (in the case of wall brackets, batten points, bulk head and similar fittings).
- Call bell buzzer (in the case of the works "via the ceiling rose/socket outlet or bell push where no ceiling rose/socket outlet is provided").

15.2.1 Circuit wiring

Circuit wiring shall mean the length of wiring from the distribution board upto the tapping point of the nearest first points of that circuit, viz., upto the nearest first switchboard measured along the run of wiring. Such wiring shall be measured on linear basis.

16 Electric Motor

Type : Squirrel case induction motor suitable for continuous duty.
Standards : Performance - IS 325, IEC 34 Dimensions - IS 1231, IEC 71
Site condition : Ref. Ambient -45°C Max humidity - 100%

Cast iron body with integral feet and frame. The stator core shall be that of high grade car lite insulated low loss silicon steel lamination stacked together and fully tightened. The rotor shaft made of high grade forged/rolled steel. A spacious terminal box to be provided to accommodate aluminum conductor cables.

Technical Particulars:

Rated voltage: 415V+110%
Frequency: 50Hz+3%
Temperature rise of 75oC over ambient of 45oC
Enclosure: IP 55
Type of cooling: Totally enclosed fan cooled
Acceptable makes Siemens, NGEF, CGL, KEC

16.1 Auto transformer starter

Automatic auto transformer starter shall be assembled in 14 SWG sheet steel, floor mounted with following accessories

- Oil immersed auto transformer with 50%, 65% and 80% tapping including first filled oil.
- Bimetallic overload relay

Timer on delay and off delay.
Ammeter with CTS and selector switch.
Voltage with selector switch.
No voltage release
Indicating lamp, Power On, Trip
(Single phasing current sensing preventer with protection CTS)
Thermostat for oil temperature. (Optional)

17

Earthing

- Earthing in general shall comply with C.P. (Code of Practice) 3043 of Indian Standards.
- Earth electrode either in the form of pipe electrode or plate electrode should be provided at all premises for providing earthing system.
- As far as possible, all earth connection shall be visible for inspection and shall be carefully made.
- Except for equipment provided with double installation all the non-circuit carrying metal parts of electrical installation are to be earthed properly. All metal conduit trunking cases. Sheets, switch gears, distribution fuse boards, lighting fittings and all other parts made of metal shall be connected to an effective earth electrode.
- The main earth electrode should be a G.I perforated pipe driven into the soil as per standard practice. continuous looped earthing should be provided with adequate size G.I. wire /feat. Earthing work should conform to I.E. Rules.
- The electrodes shall be situated at a distance not less than 3.0 m from the building fencing structure and equipment foundations. The earth pit shall conform to IS: 3043 and GI earth electrodes of not less than 100 mm external dia shall be driven to a depth of at least 3 m in the ground below the ground level. The surrounding the electrodes, soil shall be treated up with salt, coke and charcoal.
- Earth electrodes shall be installed near the main supply point and shall comprise a copper/GI earth of appropriate diameter and driven to depth of 3 metres below ground level or to a greater depth, if so required to obtain a sufficiently low earth resistance value. Alternatively, copper plate may be used as the main earth electrode conforming to IS: 3043. The electrodes shall be driven at least 3 m away from the building or any other earth station.

Minimum requirement of earth pits as per I.E. rules are as under:

- Two numbers independent for transformer body
- Two numbers independent for transformer neutral
- Two numbers independent for four pole structure
- One number for lightning arrestors.
- Two numbers of L.T. panel at sub-station and at pump house.
- the main earth electrodes after being driven into the ground shall be protected at the top by constructing a concrete or block masonry chamber of size 300 mm x 300 mm x height 300 mm. and shall be provided with CI cover. The resistance of any point in the earth continuity system of the installation to the main earth electrode shall not exceed 1.0 ohm. The remaining space in the borehole shall

be filled with bentonite. The bentonite will hold the earth rod in position. The neutral conductor shall be insulated throughout and shall not be connected at any point to the consumers earthing system.

- An earth continuity conductor shall run continuously from the farthest part of installation to the main earth electrode and shall be connected by branch conductor to all metal casing and sheathing housing electrical apparatus and/or wires and cables. All branch shall be connected to earthing. The earth continuity conductors shall have a cross-sectional area at least half to the size of the phase conductor and in no case less than 1.5 sq.mm of copper/GS.
- All earth wires and earth continuity conductor shall be galvanized M.S flats of appropriate size. Interconnections of earth continuity main conductors and branch wires shall be brazed properly, ensuring reliable. Permanent and good electrical connections. The earth lead run on structures must be securely bolted. Neutral earth leads shall be run on separate supports without touching the body of the transformers. Earth wires shall be protected against mechanical damage and possibility of corrosion particularly at the junction points of earth electrodes and earth wire interconnections. Earth electrodes shall be connected to the earth conductors using proper clamps and bolt links.
- It shall not be allowed to use the armour of the incoming feeders cable to the sub-distribution board as the only earthing system.
- Sheathed lugs of ample capacities and size shall be used for all underground conductors for sizes above 3 mm² whenever they are to be fitted on equipment of flat copper conductor.
- The lugs shall be fitted on equipment body to be grounded or flat copper only after the portion on which it is to be fixed is scrubbed, cleaned of paint or any oily substance on a subsequently tinned.
- No strands shall be allowed to be cut in case of stranded ground round conductors. G.I embedded conduits shall be made eclectically continues means of good continuity fixing and also be rounding copper wires and approved copper clamps.

17.1 Earthing of Lighting Poles

All external poles are to be looped together with continuous 8 SWG GI earth wire clamped at dollies provided on every fuse box of poles and looped onwards to the other pole. Every fifth pole shall be connected to earth through an earth electrode.

17.2 Earthing for Lighting Installation

This shall be common grid system, the main grounding conductor laid and embedded in concrete being grounded at earth pits outside the buildings at approved locations or other places. The earthing of L.T. panels shall be connected to two main grounding conductors each of which along with main cables shall run with cables to distribution boards in which floor. This shall run along with the cable and at the top floor be connected same section completing the grid.

17.3 Sizes of Earthing Conductors

| S No | . System | Earthing conductor size and Material | |
|---------|--|--------------------------------------|--|
| | | Buried in ground/ | Above ground concrete |
| - | Main earthing grid | 40 X 10 mm Copper | ----- |
| | 22 kV outdoor sub-station | 40 X 10 mm Copper | 50 X 6 mm GS and 22 kV switchgear |
| - | 415 V switchgear, | suitable to its | Suitable to its rating. |
| | Battery charger | - | 25 X 3 mm GS |
| - | 415 VLT Motors | | |
| - | Valve motors | 10 | SWG GS wire |
| - | 0 - 15 HP | 8 | SWG GS wire |
| - | 15 - 40 HP | 4 | SWG GS wire |
| - | 40 - 50HP | | 25 X3 mm GS flat |
| - | 50 HP and above | | 25 X6 mm GS flat |
| - | Lighting distribution Board, 30 V DC Tripping Unit. | | 25 X 3 mm GS flat |
| - | Local Push Button stations, Junction Boxes. | | 14 SWG GS wire |
| - | Lighting and receptacle system | | 12 SWG GS wire |
| - | earth Electrode | | 50 mm dia. 3000 mm long heavy duty GI Pipe electrode |
| - | Street lighting Poles | | 8 SWG GS wire |

- Notes:
1. Conductors above ground shall be galvanized steel to prevent atmospheric corrosion.
 2. Conductors buried in ground or embedded in concrete shall be mild steel.

3 Drawings; The typical earthing details are shown on drawing.

17.4 Battery, Battery Charger & DC Distribution Board

- The charger and DC distribution board shall be enclosed on a common sheet steel enclosure with necessary compartment for each incoming and outgoing feeder.

- Complete information regarding battery layout, space requirement for locating battery, wall painting of battery room floor, ventilation, method of lighting etc. shall be supplied by the Contractor. The battery room shall preferably be located inside MCC room as shown. The battery room shall have acid proof tiles as flooring and up to 4 ft. level. Also there shall be an exhaust fan of appropriate capacity to extract vapors from the room.

17.5 Tests

Batteries and battery chargers shall be routine tested before dispatch, in accordance with Indian Standards. Capacity test shall be carried out on the batteries at site after installation.

18. Street Light

Street Light fixtures shall be complete with 35 Watts DIE CAST Aluminum LED Light Fittings.

19. Street Light Poles

Street Light Poles shall be of 6 mtr GI Coated Spiral Pole Shaft (size 70x130x3mm. Effectively 5.50 mtr mounting height of the luminaries & total height - 6 mtr), Base plate-200x200x12 mm, PCD-200 with Two coats of Polyurethane Anti Corrosive Paint over a base coat and its accessories. (including Supply of foundation Bolt (M16x500- 4 Nos) template and base plate-200x200x12 mm, Bracket- Single, packing and forwarding charges and all taxes and duties etc. complete. (for STP Campus lighting) A suitable MS box to have 5A control switch, 16A fuse unit with suitable frame work shall be fitted in the street light mast with door and locking arrangements.

A terminal box with fuse shall be fixed in all the poles.

20. Capacitor

To improve the power factor capacitor shall be provided in the LT bus bar in the sub-station.

- The capacitor shall be as per ISS 2834 and IS 2544.
- The capacitor shall be all polypropylene film capacitors. The film shall be oriented bi-axially.
- The oil used for impregnation under vacuum shall highly purified non- toxic.
- Low loss discharge resistance, to reduce the residual voltage to 50V or less within one minute after the capacitor is disconnected.
- The capacitor container shall be painted with epoxy-based paint, to prevent corrosion/rusting.
- 4 stage switching ON/OFF shall be provided to match with the load.
- Automatic Power Factor Correction Unit shall be provided if necessary.

21. Safety

The following minimum safety equipment shall be supplied and installed in the Sub-Station switch rooms and Diesel Generating rooms.

- Portable chemical fire extinguishers conforming to IS 935 or its latest version shall be supplied and installed at the Sub-Station, Switch rooms and Diesel Generating Stations.

- Fire buckets with M.S. angle stand each consisting of 4 Nos. round bottom fire buckets painted with red and marked fire and filled with clear dry river sand shall be supplied and installed at a convenient location at the proposed Sub-Station.
- First-Aid boxes equipped fully with required materials, shall be supplied and kept at a convenient place in the Switchgear room so that the same is easily accessible.
- Shock Treatment chart.
- Rubber matting of not less than 25 mm. thick and 600 mm width and standard lengths, shall be provided in front of all the switch gear panel, Transformer, Control cubicles, etc.
- Rubber gloves tested for 15 KV about 4 sets shall be supplied.

22. Diesel Generating Equipment

Supply delivery erection Testing and commissioning of Silent Outdoor Generator set of following capacities with complete enclosure with lock and key arrangement mounted on suitable concrete pedestal as per standard specification and model with suitable Diesel Engine, water cooled, developing required BHP, electrical starting arrangements, coupled with alternator of appropriate capacity with silent proof ecofriendly genset of reputed make 3 phase 415V 1500rpm with AMF Panel, base frame, fuel tank, radiator, battery with lead with other std accessories with powder coated canopy designed like box structure and acoustic enclosure silencer mounted inside/outside canopy lockable doors, fuel filling arrangements externally accessible emergency stop button and temperature raise inside canopy maintained with 5 to 7 degree etc., complete with central pollution control board approved type with ISI marking and third party inspection certificate etc., complete including erection and commissioning complete with cables. DG SET AMF PANEL Specifications: The control cubical shall be of fabricated construction made of best quality sheet metal and is of the free standing/floor mounting type. It shall be provided with removable side panels and a hinged front panel for easy accessibility. Suitable provisions for connecting incoming and outgoing loads are made on the control panel. The standard instruments to be incorporated in the AMF Panel are as follows

1.AC Voltmeter - 1 No.

2.Voltmeter selector switch- 1 No.

3.AC ammeter suitably scaled with Selector Switch.

4.Battery charging set consisting of.- 1 No.

a)Transformer/Rectifier

b) DC Ammeter-

c) Charging rate selector switch OFF/TRICKLE/OFF BOOST

d) DC VOLTMETER

5.Main supply contactor (3pole)-1 No.

6.Current Transformers- 3 Nos

7.Low voltage high rupturing capacity fuses for short circuit protection of the main supply-1 set

8.Alternator Contactor-1 No.

9. 3 Pole bimetal release for overload protection of alternator.-1 No.

10. Main voltage monitor - 1 No.
11. Set of DC control relays incorporating engine, start, stop, three attempts starting facility and failure to start, lockout.-1 No
12. Selector switch. AUTO / MANUAL. - 1 No
13. Push Button " Start".- 1 No.
14. Push Button "Test"- 1 No.
15. Push Button " Stop". - 1 No.
16. Signal Lamp for indicating " LOAD ON SET "- 1 No.
17. Signal Lamp for indicating " LOAD ON MAINS "- 1 No.
18. Signal lamp for indicating "SET FAILS TO START"
19. 4 pole Double brake fuse switches with mechanical interlock. - 2 Nos

22.1 General

- Electrical power supply for each pumping station will be availed from nearby CESU supply point. According to the load requirement HT at 11KV/22KV or LT at 415V - 3 Phase will be availed from CESU.
- One Diesel driven alternator set of capacity as specified shall be provided to permit operation of the Pumping Station in the event of failure of the CESU electricity supply, complete with all equipment like. The equipment shall conform to the latest relevant ISS or BS.
- Control gear, circuit breakers, cabling, synchronizing equipment etc.
- The engine alternator sets shall be designed such that the starting power peak shall not exceed 10 per cent of the continuous engine rating and the voltage dip shall not exceed 15 per cent whilst starting the connected load under the worst conditions.
- The Contract Drawings show the building, floors and other details as they will be constructed and the space allocated for the generating plant, control gear and circuit breakers. If any departures from the proposed layout are necessary the Contractor shall show the modifications on the drawings submitted with his Tender, and shall can attention to these suggested alterations.
- Tenderers attention is specifically drawn to the operating conditions where by generator sets could be running at little or no load due to the intermittent and differing flow rates and pump capacities.
- A system using dummy loads to maintain a safe minimum working level is envisaged and the Tenderer is required to comment upon this or any other proposed system at the time of Tender submission together with supporting documentation and calculations.

23 Statutory Approval

The Contractor shall be totally responsible for obtaining statutory approval from the electrical inspector or any other statutory authority for the entire installation carried out by him unless otherwise specified and agreed. Necessary test reports shall be submitted by him to electrical inspector. This will be an integral part of the contract and shall not be paid for separately. However, fees payable to statutory authorities shall be borne by the tenderer.

24 Acceptance of Installation

On completion of the work the Engineer, together with the Contractor, will carry out an inspecting of the installing. The Engineer will issue a completed copy of the Purchaser's Acceptance of Electrical Installation to the Contractor as confirmation that the work has been accepted, subject to any matters noted on the form being attended to.

B. PUMP SETS AND ACCESSORIES

1 General

1.1 All the Materials used shall confirm to the relevant BIS and should be delivered at site of work. The Contractor is responsible for safe custody of machinery and other equipment under this contract till handing over to the employer.

1.2 The rates should include all the minor items of civil works, if any required for installation complete.

1.3 All necessary civil works for erection of all equipment and accessories offered by the contractor under this contract should be done by the contractor

1.4 Test certificates for machinery and equipment should produce along with supply

1.5 The bidder should enclose the performance curve duly indicating the duty point for the size of the impeller selected (family curve should not be furnished). The Performance curve should furnish complete range of operation and the curve should be authenticated by the manufacturer or his authorized dealer. In the event of non-compliance of the offer shall be summarily rejected.

1.6 The contractor shall make necessary arrangements to get supply of electricity from CESU for operating the machinery and equipment. Necessary payment to be made to CESU shall be borne by the employer

1.7 Before supply of machinery, equipment and other accessories prior approval of the Engineer should be obtained giving the name of makes and other details required.

1.8 Obtaining approval of electrical layout diagram for the installation of all the equipment (transformers, generators, pump sets and other accessories) and obtaining safety certificates on completion of work from Chief Electrical Inspector to Government of Odisha should be arranged and got approved by the contractor at his cost.

1.9 All the materials should be supplied as per BOQ and should be of standard makes mentioned below;

| Sl No | Description | Make |
|--------------|---------------------------------|--|
| 1 | Submersible Pump and motor | KSB/ Calama /Waterman/Atlanta or equivalent |
| 2 | Make of Motor | Jyothi/ NGEF/ GEC/ Crompton & Greeves/ Siemens or equivalent |
| 3 | Make of Transformer | Kirloskar / GEC/ Indo TECH/ Hindustan or equivalent |
| 4 | Diesel Generator | Kirloskar/GEC or equivalent |
| 5 | Starter | L&T/ Cutler Hammer/ Siemens/ Siemens/MEI or equivalent |
| 6 | Switch Fuse and circuit breaker | L&T/ Cutler Hammer/ / Siemens,/MEI or equivalent |
| 7 | Cables | Finolex / Unista / Uniflex, or equivalent |
| 8 | Valves | Kirloskar /Venus/ Upadyaya CALSONS / or equivalent |

1.10 The right of choosing the make among the makes offered by the contractor rest with the employer only

1.11 The submersible pumps centrifugal pumps, turbine pumps, submersible motors, motors for turbine and centrifugal pump set transformer, generators, Panel Boards, to be supplied by the firm will be inspected by the Inspecting Agency fixed by the Employer at the manufacturers premises and test certificate will be issued. The contractor should make necessary arrangements for the inspecting staff at his own cost for testing the above pump sets.

1.12 If the complete plant or any portion thereof is found to be defective the Engineer shall give the contractor a notice in writing to verify such defects. If the contractor fails to rectify the defects within the specified period, the Engineer will rectify the defects at the contractor's risk and cost.

2 (a) SUBMERSIBLE PUMP

The pump shall be of latest standard designed to give maximum efficiency when operated under most exacting condition at speed 1500/3000 rpm. The equipment shall conform to the following specifications as per IS 8030 – 1996.

i) PUMP BOWL

The pump bowl shall be manufactured to offer resistance to corrosion. The bowls may be equipped with replaceable bearing.

The bowl assembly shall bear a name plate giving the following information.

- a. Name of the manufacturer or trade mark
- b. Serial Number of the pump set
- c. Pump type
- d. Number of stages
- e. Total head
- f. Capacity
- g. Speed

ii) IMPELLERS

The impellers shall be open or closed or semi closed type. They shall be turned and accurately finished and balanced on their own pump shaft for maximum lifting capacity without over loading the prime mover irrespective of water level fluctuations. The impeller may be of the enclosed or semi enclosed type and shall be properly balanced. Dynamic balancing is recommended. Enclosed impellers may be equipped with sealing rings on their hubs.

iii) PUMP SHAFT

The pump shaft shall be stainless steel of ample size and stiffness to transmit maximum power without strain or vibration. The pump shaft shall be guided by bearings provided below and above the impeller shaft assembly. The shaft without protecting sleeves shall have a surface finish of 0.75 micron.

iv) BEARING SLEEVE

The bearing sleeve shall be of leaded bronze

v) DISCHARGE CASING

The discharge casing shall be manufactured to offer resistance to corrosion

vi) SUCTION CASING

The suction casing shall be manufactures to offer resistance to corrosion

The opening in the suction case of the entrance shall be of proper size and shape to reduce loss.

The suction case shall be fitted with a strainer made of corrosion resistant materials.

Suitable guard shall be provided just above the suction case bearing to prevent the entry of foreign matter into the suction case.

vii) COUPLING

A suitable coupling arrangements shall be provided in case of directly coupled pump sets.

viii) NON RETURN VALVE

Non return valve shall be provided above the pump discharge case.

9.CHARACTERISTIC CURVES;

The performance curves for the full range of operation indicating the head in metre, efficiency and BHP absorbed at the pump shaft against the output in litres per minute shall be furnished.

2(b) SUBMERSIBLE MOTORS

i) TYPE

The submersible motor shall be wet type, squirrel cage induction motor suitable for operation on 360/440 Volts. 3 phase 50 Cycles AC supply and capable of developing the required HP at a speed 1500/3000 RPM. The motor windings and the bearing bushes of the rotor shaft shall be lubricated by pure water or oil, filled in the motor before erecting the pump sets. The motor shall conform to IS 9283 – 1979

The motor shall be connected by means of cable glands rubber seals etc., from inside of bore well to arrest the entry of sand and other foreign matter.

The motor shall be provided with a breathing attachment like bellows diaphragm etc., to compensate the Volumetric variation due to changes in the temperature. The motor shall be made of corrosion resisting materials or suitable treated materials to resist corrosion under normal condition.

ii) BEARINGS

The thrust bearing shall be of adequate size to withstand the weight of all rotating parts as well as the imposed hydraulic thrust. These shall be lubricated suitably. The thrust bearing housing shall be provided with a drain plug to empty the oil pure water filled into thrust bearing housing rotor.

iii) MOTOR

The motor shaft shall be provided with shaft protective sleeves having a surface finish of 0.75 micron.

iv) EARTHING ARRANGEMENT

The earthing of motor shall comply with IS:3043-1966 Code of practice for earthing provision shall be made for double earth copper connection. Two separate lead should be taken to two separate earth pits located outside the pump house.

V) TEMPERATURE RISE

The insulation should be perfect so as to limit the temperature rise in windings.

vi) OUTPUT

The motor shall be capable of developing the Mechanical output for the required conditions and shall have continuous normal rating to suit the maximum load when operated at the pump speed.

vii) TECHNICAL DATA

The motor HP shall be such that to safety take the load when the total head is reduced by the rise of water level.

The H.P. of the motor offered shall have a Margin above the H.P. absorbed by the pump set at duty point and also above the maximum BHP absorbed by the pump sets at duty point and also above the maximum absorbed by the pump set offered.

ix) OVERLOAD CAPACITY

The motor shall be capable of withstanding the over load specified in the relevant condition of BIS.

x) STARTING

The motor shall give full load torque when taking 1 to 1.5 times full load current. The motor shall have a name plate giving the following information.

- a. Induction motor
- b. Name of manufacturer.
- c. Manufacturers number & frame reference
- d. Type of enclosure
- e. B.H.P.
- f. Rated voltage and winding connections.
- g. Rated output in K.W.
- h. Number of phases i.
- Frequency in HZ
- j. Current approximate in amperes at rates output
- k. Speed in revolutions per minute at rates output

STARTERS

The Starters shall suitable for the Motor offered. This should have single phasing preventer, mounted on Ammeter, suitable capacity fuses etc., with all the standard safety devices such as no volt coil, overload releases with time lag arrangements dry running preventer suitable inter locking devices, cable entries, name plates and earthing facilities etc.,

These starters to be supplied should be of DOL up to a range of 5 HP, Star delta starter up to the range of 15 HP and Auto transformer starter above range of 15 HP.

SWITCH BOARD

The switchboard shall complete with all necessary internal connections and accessories as mentioned in the BOQ and as per latest IE Rules and CEIG regulations. This switchboard should contain all equipment house in cubicle, the bus bars should have ample current carrying capacity for connected load and painted with powder coated painting.

CABLES

The cables shall be supplied as mentioned in BOQ with ISI mark, Laying and jointing of cables shall be as per IE Rules. The cable should have current carrying capacity to withstand overload due to low voltage drop. Cable jointing should be done in such manner that there is adequate bondage strength and safety to equipment and operators.

EARTHING

Twin copper earthing of the plant and equipment shall be done as per IS 3043/1966 and IE Rules 1996 and amended from time to time. Two separate lead should be taken to two separate earth pits located outside the pump house.

PUMPHOUSE, WIRING AND LIGHTING

Pump house wiring and lighting shall be carried out, as per IE Rules with sufficient no of light points, lamps and other accessories (to be supplied by the contractor) as prescribed in the BOQ and shall be of standard make.

LAYING AND JOINTING

The items of laying and jointing of pipes, specials and valves should include the necessary clamps, supports, trenches, wherever necessary.

Supporting studs, bolts, nuts, washers, necessary jointing materials together with spare bolts and nuts and jointing materials shall also be supplied free of cost.

ERECTION AND TESTING

The contractor shall provide a skilled Engineer and skilled labour for the entire execution of the work and final testing of the plants at sites.

All erection tools including spanners, dye sets, etc. shall be supplied by the contractor and the contractor's representatives shall have full and uninterrupted access to the site during erection.

The employer may depute any officer under his control to visit the work at any time during the stage of erection for inspection. The plant shall be tested by employer. Post / delivery inspection by the third party inspection agency in the presence of the firm's engineer or any other representative to ensure performance and all testing equipment as may be reasonably required shall be provided by the contractor.

Installation testing and commissioning should be in accordance with relevant ISS. The pre delivery inspection certificate for the pump sets, panel board and other equipment for transformer to be obtained by the bidder.

SPARE PARTS

Supply of spares and Tools shall be made as per the list prescribed in BOQ with index card.

TOOLS

Standard tools for the maintenance of the equipment shall be supplied as detailed.

| | |
|--|--------|
| D/E Spanners | 1 set |
| Ring spanners | 1 set |
| Bearing puller | 1 No. |
| Grease gun | 1 No |
| Hand Gloves tested for Electrical operation | 1 pair |

| | |
|-------------------|-------|
| Ball Peen hammer | 1 No |
| Screw drivers | 1 set |
| Electrical tester | 1 No |
| Electric megger | 1 No |

3. Submersible Sewage pump

Non clog submersible pump set

General

The submersible sewage pump shall be mono-block type of non-clog design. It shall be suitable for pumping raw unscreened sewage containing sludge, long fibers, plastic pieces, cigarette butts, etc. The pump shall be able to pass through soft solids of minimum 100 mm dia and capable of dealing with sewage / sludge with specific gravity of 1.05. Pumps shall be of 960 rpm for high duty pump and 960/1450 rpm for low duty pump sets.

Impellers shall be of single / double vane non-clog design. Additionally, a special contra-block cutting and tearing system should also be incorporated on the suction side of the pump for disposing off soft material which would otherwise clog the pump.

Maintenance free antifriction, permanently grease filled ball bearing shall be provided and this shall take care of all the axial and radial forces at any point of operation. The weights of the revolving parts of the pumps including the unbalanced hydraulic thrusts of the impellers shall be carried by thrust bearings provided in each pump assembly.

The pump installation design shall be such as to facilitates automatic installation and removal of the pump without having to enter into the sewage pit. Profile gasket shall be provided in automatic coupling system so to avoid metal to metal contact between the pump and delivery bend to ensure leak-proof joint.

Pump Construction

Pump Casing

Pump casing shall be of CI as per IS 210 Gr FG 200 with 2.0% to 3.0% nickel. The internal surfaces shall be free of rough spots. The casing shall have centerline discharge.

The high capacity pumps at New Pump house shall work in parallel two at a time to discharge peak flow. Third pump will be stand by.

Impellers

Impellers shall be of stainless steel (CF8M) construction. Impeller shall be of single/double vane non clog design. Additionally, a special contra-block cutting and tearing system should also be incorporated on the suction side of the pump for disposing off soft material which would otherwise clog the pump.

Pump Shaft

The pump shaft shall be of stainless steel (SS-410) as per manufacturer's standard. The shaft shall be of one-piece construction.

4. TESTING OF PLANT:

General

The requirements for testing shall be as specified below.

Pumps, valves and pipework and general purpose machinery Off-site inspection and testing

(a) Pumps

Pumps shall be individually tested in accordance with Relevant IS Code and the tests shall be with clean water. Site conditions shall be simulated as nearby as possible including the NPSH condition. Pumps shall be tested with their own prime movers. Where it is impracticable to include the full length of the connecting shaft, the Contractor shall state the allowances to be made for the losses incurred by its omission and shall demonstrate the accuracy of the allowances to the satisfaction of the Engineer. Pumps shall be tested at the guaranteed duty point and over the full working range from the closed valve condition to 20 percent in excess of the quantity when a single pump runs alone at minimum head. The tests shall provide information for performance curves to be drawn for head/quantity, efficiency/quantity, power absorbed/quantity and net positive suction head/quantity. Readings shall be taken at a minimum of seven points in addition to shut-off condition. Each pump shall also be run at its duty point for at least 30 minutes. Positive displacement pumps shall be tested in accordance with BS EN ISO 9906.

For eccentric helical rotor pumps the tests shall provide information for performance curves to be drawn for pump speed/flow, input power absorbed/flow differential pressure/flow and pump efficiency/flow.

Pump casings shall be subject to a pressure test at 1.5 times the pressure obtained with the delivery valve closed. The positive suction head when installed shall be taken into account in determining this pressure. During the test, the casing and joints shall show no signs of leakage, distortion or defect.

In addition to confirming the specified hydraulic performance of the pump set, the test shall demonstrate that vibration is within the specified limits, the mechanical performance is satisfactory and the noise level is within the specified limit.

Additionally, chemical dosing pumps shall be tested in accordance with API standard 675 and the specified flow linearity, steady state accuracy and flow rate shall be demonstrated.

(b) Gate valves

Gate valves shall be tested in accordance with relevant IS Codes or equivalent whichever applies, valve seat tests shall be made under open-end conditions, the test pressure being applied to each face of the valve in turn.

(c) Butterfly valves

Butterfly valves shall be tested in accordance with IS Codes or equivalent. The seat test shall be for tight shut-off and low leakage. Valves shall be tested under maximum unbalanced water test pressure in either direction.

(d) Air valves

Air valves shall be water tested for drop-tightness at all pressures from 0.2 bar in steps of 2 bar up to the specified pressure. The valve body shall be water tested at 1.5 times the specified pressure, at which pressure no damage or permanent deformation of the valve body, ball or seat shall occur. Two valves of each type and size incorporating large orifices shall be tested for exhaust of air at a

differential pressure up to 1 bar in steps of 0.1 bar and for inflow of air at a differential pressure up to 0.5 bar in steps of 0.1 bar. During the tests the air flow rates shall be measured by orifice plates in accordance with BS 1042. Pressures (positive or vacuum) shall be measured by Bourdon tube gauges or by mercury-in-glass manometers. The temperature of the flowing air shall be measured in accordance with relevant parts of IS Code or equivalent. The barometric pressure shall also be measured.

If the manufacturer provides results of independently witnessed air flow tests similar to those specified and these are accepted by the Engineer, the specified airflow tests shall be deemed to be completed.

(e) Pressure and flow control valves

Pressure and flow control valves shall be tested hydrostatically as follows;

| | |
|-------------------------|--|
| Body strength: | closed-end test, valve open, test pressure 1.5 times working pressure; |
| Valve element strength: | open-end test, valve closed, test pressure of 1.5 times working pressure applied to each end; |
| Leak tightness: | open-end test, valve closed, test pressure of the working pressure applied to inlet end, no visible leakage permitted. |

(f) Pipe work

Pipe work shall be tested in accordance with the appropriate IS Codes or equivalent.

(g) Castings

Castings shall be tested hydrostatically to 1.5 times the maximum working pressure for a minimum period of 1 hour.

(h) Surge vessels

Surge vessels shall be tested in accordance with the relevant IS Codes or equivalent.

Electric motors

Off-site inspection and testing

Motors shall be inspected and tested to show that they are compliant with the Specification and approved drawings.

Tests shall be in accordance with the relevant IS Codes or equivalent.

For low voltage standard production motors for general use, the tests shall be routine checks. For high voltage and low voltage motors for main drive application, the tests shall be duplicate. If the test to determine the locked rotor current of cage induction motors is carried out at reduced voltage, allowance shall be made for the effect of saturation when adjusting for rated voltage. The estimated value of locked rotor current at rated voltage shall be stated on the test certificate.

A Polarisation Index test shall be carried out for high voltage motors.

The requirement for "basic" or "special" tests shall be as specified.

Individual Tests

Each motor shall be inspected prior to site testing for;

- Absence of damage during transportation and erection;
- Absence of moisture or other contamination;
- Ventilation openings and drain holes are free of debris;
- Cable glanding and core terminations for tightness and identification;
- Free rotor rotation;
- Free movement of brush gear;
- Remote start / stop / E. stop control box wirings and arrangement;
- Starting interlocks

Unless otherwise specified the following tests shall be carried out on each motor before energizing;

- Winding insulation resistance;
- Polarization Index for high voltage motors;
- Insulation resistance between motor and heater windings and ancillary devices;
- Calibration of winding and bearing temperature monitoring devices and the operation of alarm and trip initiating contacts;
- Continuity and resistance of winding thermistors;
- Bearing insulation integrity;
- Brush pressure.

Any other tests recommended by the manufacturer or stipulated in the relevant IS Codes or equivalent. On the satisfactory completion of the inspection and tests listed above, motors shall be energized to check for correct direction of rotation, noise and the vibration levels are within the specified limits. The tests shall be carried out with the motor uncoupled from the driven plant.

Transformers

Off-site inspection and testing

Transformers shall be inspected and tested to show that they are fully compliant with the Specification and approved drawings and shall include the following tests as a minimum;

- Routine tests;
- Measurement on winding resistance;
- Ratio, polarity and phase relationship;
- Impedance voltage;
- Load loss;

- No-load loss and current;
- Insulation resistance;
- Induced over voltage withstand;
- Separate source voltage withstand;
- Magnetic circuit voltage withstand
- Transformer tank oil leakage test (1 kg/cm² for 24 hours);
- Transformer noise level measured in accordance with methods and procedures detailed in IEC 551 -Noise level shall not exceed 65dBA;
- Tap changer switching, mechanical and electrical tests according to BS4571;
- Zero sequence impedance measurement;
- Type tests;
- Impulse voltage withstand test;
- Temperature rise test;
- On load tap changer panels;
- Operational tests;
- Sequence tests.

Unless otherwise stated by the Engineer at the time of placing the order, evidence of records of satisfactory type test carried out on identical transformers to those ordered will be accepted in lieu of actual tests on transformers manufactured under this Contract for impulse voltage withstand test. Temperature rise test shall be carried out on one transformer of each size and type. The guaranteed no-load and load losses of each transformer shall be verified at the manufacturer's works. The positive tolerances stipulated in BS 171 shall not be accepted. The Board reserves the right to reject any transformer which does not achieve its declared guaranteed values.

Individual Tests

The Site inspections and tests to be carried out are as follows;

- Ratio, polarity and phase relationship;
- Impedance voltage;
- Insulation resistance;
- Oil and winding temperature gauges shall be calibrated and tested;
- Pressure gauges and oil level indicator relays shall be tested with pilot cables connected by mechanical operation of contacts;
- Tap changer equipment including protective devices shall be tested to ensure correct operation;
- Oil tests;

Samples of insulating oil shall be taken and subjected to dielectric strength tests. If the insulating oil fails the site test, the Contractor shall carry out the drying of oil to remove the moisture content or replace the oil and then carry out the oil tests again to comply with the relevant IS Codes or equivalent.

5. COMPLETION PLANS

The successful bidder shall be requested to furnish completion plans in triplicate within one month from the date of the first testing of the plants. The plan should show the entire layout of the plant executed. Five copies of plan should be supplied to the Employer and one to be framed and suspended in the Head works. The contractor shall in addition to the above furnish detailed specifications of the equipment provided to the Employer with all technical data.

6. MAINTENANCE MANUAL

The periodical maintenance schedules for each equipment shall be given with reference to the hours of operation. Detailed information about the spare parts (part name, identification number etc.) should be given. The copies of the manuals should be furnished within one month from the date of commissioning.

7. The contractor should supply one set of tools for the pump set maintenance of the machinery and equipment supplied by them under this contract.

8. General

8.1 Cable lengths given are only approximate and payment will be made for the actual lengths of cable laid.

8.2 The contractor has to make necessary arrangements to get supply of electricity from CESU for operating the machinery and equipment. The necessary service connection and Security Deposit charges will be paid by the Board.

8.3 The Contractor should obtain all approvals for the installation and commissioning of machineries and accessories offered by them from the respective inspecting authorities etc. Fees if any, to be paid to the inspecting authorities will be reimbursed by the Board.

8.4 Before supply of the machinery equipment and other materials, prior approval of the Engineer should be obtained giving the name of maker and other details required.

9 Electrical Wiring and installation of fittings

9.1 The materials used for conforms to the relevant I.S.S wherever applicable. The make and other details of materials to be used should be furnished along with the tender.

9.2 Continuous earth connection are to be made with 14 SWG T.C. wire.

9.3 The wiring work done shall be neat, true to line, level etc. and in such a way that it gives an impressive and aesthetic appearance to the building.

9.4 The actual location and number of points for lights, fans power plugs etc. may be altered at the time of execution by the Engineer.

9.5 Entire wiring and cabling work should be done as per IE rules.

9.6 Any damages or breakages, chipping etc. caused by the electrification works to the structures have to be rectified by the contractor at his cost to the satisfaction of the Engineer.

- 9.7. The Contractor has to test and every point after completion of wiring to the entire satisfaction of the Engineer by taking temporary supply from the existing service.
- 9.8. Wiring to light point (both internal and external) and fan point will be treated as complete only when supply as well as connection up to the ceiling rose is completed.
- 9.9. Whenever conduit pipe wiring is done, cover for switch boards containing switches, plugs, etc. should be of hylam sheet or other specified sheet only.

C.PUMPSETS AND ACCESSORIES (Non-Clog)

1 General

- 1.1 All the Materials used shall confirm to the relevant BIS and should be delivered at site of work. The Contractor is responsible for safe custody of machinery and other equipment under this contract till handing over to the employer.
- 1.2 The rates should include all the minor items of civil works, if any required for installation complete.
- 1.3 All necessary civil works for erection of all equipment and accessories offered by the contractor under this contract should be done by the contractor.
- 1.4 Test certificates for machinery and equipment should be produced along with supply.
- 1.5 The bidder should enclose the performance curve duly indicating the duty point for the size of the impeller selected (family curve should not be furnished). The Performance curve should furnish complete range of operation and the curve should be authenticated by the manufacturer or his authorized dealer. In the event of non-compliance, the offer shall be summarily rejected.
- 1.6 The contractor shall make necessary arrangements to get supply of electricity from CESU for operating the machinery and equipment. Necessary vouchers in original for the payment made to CESU shall be produced to the employer by the contractor which shall be reimbursed by the employer.
- 1.7 Before supply of machinery, equipment and other accessories prior approval of the Engineer should be obtained giving the name of makes and other details required.
- 1.8 Obtaining approval of electrical layout diagram for the installation of all the equipment (transformers, generators, pump sets and other accessories) and obtaining safety certificates on completion of work from Chief Electrical Inspector to Government of Odisha should be arranged and got approved by the contractor at his cost.
- 1.9 All the materials should be supplied as per BOQ and should be of standard makes mentioned below;

| Sl No | Description | Make |
|--------------|---------------------------|--|
| 1 | Non-Clog Submersible Pump | Kirloskar / Kishore / KSB / Grundfos / Aqua. |
| 2 | Make of Motor | Jyothi/NGEF/GEC/Crompton & Greeves/ Siemens |
| 3 | Make of Transformer | Kirloskar/GEC/Indo TECH/Hidustan |
| 4 | Diesel Generator | Kirloskar/GEC |
| 5 | Starter | Built by any CPRI approved panel builder |

| | | |
|---|---------------------------------|---|
| 6 | Switch Fuse and circuit breaker | L&T/Cutler Hammer/Siemens/Schnider |
| 7 | Cables | Finolex/Unista/Uniflex, or equivalent ISI branded |
| 8 | Valves | Venus/Upadyaya/CALSONS/Durga |

- 1.10 The right of choosing the make among the makes offered by the contractor's, rest with the employer only.
- 1.11 The submersible pumps centrifugal pumps, turbine pumps, submersible motors, motors for turbine and centrifugal pump set transformer, generators, Panel Boards, to be supplied by the firm will be inspected by the Inspecting Agency fixed by the Employer at the manufacturers premises and test certificate will be issued. The contractor should make necessary arrangements for the inspecting staff at his own cost for testing the above pump sets.
- 1.12 If the complete plant or any portion thereof is found to be defective the Engineer shall give the contractor a notice in writing to verify such defects. If the contractor fails to rectify the defects within the specified period, the Engineer will rectify the defects at the contractor's risk and cost.

2 Submersible Sewage pump

Non clog submersible pump set

General

The submersible sewage pump shall be mono-block type of non-clog design. It shall be suitable for pumping raw unscreened sewage containing sludge, long fibers, plastic pieces, cigarette butts, etc. The pump shall be able to pass through soft solids of minimum 100 mm dia and capable of dealing with sewage / sludge with specific gravity of 1.05. Pumps shall be of 960 rpm for high duty pump and 960/1450 rpm for low duty pump sets.

Impellers shall be of single / double vane non-clog design. Additionally, a special contra- block cutting and tearing system should also be incorporated on the suction side of the pump for disposing off soft material which would otherwise clog the pump.

Maintenance free antifriction, permanently grease filled ball bearing shall be provided and this shall take care of all the axial and radial forces at any point of operation. The weights of the revolving parts of the pumps including the unbalanced hydraulic thrusts of the impellers shall be carried by thrust bearings provided in each pump assembly.

The pump installation design shall be such as to facilitates automatic installation and removal of the pump without having to enter into the sewage pit. Profile gasket shall be provided in automatic coupling system so to avoid metal to metal contact between the pump and delivery bend to ensure leak-proof joint. Pump Construction Pump Casing

Pump casing shall be of CI as per IS 210 Gr FG 200 with 2.0% to 3.0% nickel. The internal surfaces shall be free of rough spots. The casing shall have centerline discharge.

The high capacity pumps at New Pump house shall work in parallel two at a time to discharge peak flow. Third pump will be stand by.

Impellers

Impellers shall be of stainless steel (CF8M) construction. Impeller shall be of single/double vane non clog design. Additionally, a special contra-block cutting and tearing system should also be incorporated on the suction side of the pump for disposing off soft material which would otherwise clog the pump.

Pump Shaft

The pump shaft shall be of stainless steel (SS-410) as per manufacturer's standard. The shaft shall be of one-piece construction.

Pump Bearings

Pump bearings shall be of the antifriction type. The bearings shall be able to take normal thrust loads due to unbalanced hydraulic loads on the impellers plus the weight of all rotating parts of the pumps. Pump bearings shall be designed with a minimum life of 40,000 hours. The bearings shall be grease lubricated for life, and shall be maintenance free.

Guide Rail Assembly

The assembly shall have CI pedestal, bracket, delivery bend, MS Galvanised guide rail pipe of 50 mm NB of Class C, upper guide rail holder, etc. The pedestal and bracket shall provide automatic coupling between pump delivery flange and discharge bend (standard bend / duck foot bend). Alternatively, the guide system can be with wire rope and pedestal cast integrated with discharge bend.

Mechanical Seals

Double mechanical seal shall be provided to prevent pumped liquid entering into the motor winding. The seal shall be situated in oil chamber to ensure proper lubrication. The seals shall be fail proof at the depth of submergence involved in each case.

The face combination of lower mechanical seal shall be silicon carbide. Vs. Silicon carbide and upper mechanical seal shall be Carbon Vs Chrome Steel.

Moisture Sensor

Moisture sensor (seal monitor) shall be provided in the oil chamber to detect the failure of the mechanical seal. The sensor will trip the pump-motor in the event of ingress of moisture into the oil chamber.

Lifting Chain

Each pump shall be provided with carbon steel lifting chain of adequate strength. The chain shall have rings of same size, fixed at an interval of about 1M for engaging the hook of the chain pulley block.

Foundation Nuts and Bolts

S.S. foundation nuts and bolts shall be provided

Protective Coating

The pumps shall be epoxy painted

Pump Balance

All rotating parts shall be statically and dynamically balanced as per the relevant standards.

Submersible Motor

Motor shall have integral cable entry port and cable entry shall be properly sealed. It shall have provision for preventing reverse rotation. Each phase of the motors shall be provided with thermic switches with bimetallic electromechanical temperature detectors. The motor shall operate satisfactorily at all operating levels in wet well. Motor shall be sealed against entry of liquid being pumped by using two mechanical seals.

Submersible Motor Cable

Each pump shall be provided with submersible cables as specified in BOQ both for power and control cables.

Special Condition

The make of the submersible pump offered by the tenderer should be of known performance in OWSSB. The tender should also furnish the list of authorized dealers for the supply of spares for submersible pumps and list of authorized workshop for carry out repairs to the submersible pumps along with the address while tendering.

The submersible pumps shall be suitable for pumping contaminated effluents, industrial waste water, storm water, sewage etc.

The pump shall be vertical spindle type, having duties as specified below. The pumps shall be capable of handling 100 mm size solids. The impeller shall be non-clog and semi-open type.

Double mechanical seals shall be provided. Pump sets shall have double bearing between pump and motor. Pumps shall be provided with automatic coupling device and all necessary fixings for guiding the pumps during lifting/lowering. The pump shall not exceed 960rpm. Casing shall be of cast iron with 2%-3% nickel Impeller: SSCF8M, shaft SSAISI 410. Guide rail system – CI/SGI.

Motor to be of appropriate rating for the proposed pump duty. Submersible squirrel cage induction motor suitable for coupling with the pump without overload conforming to specifications. Starting current shall not exceed 200% of rated full load current. Protection against increase in stator winding temperature (155° C) shall be provided. Class of insulation shall be F. The degree of protection shall be IP68 as per IS 4691. Motors shall be suitable for continuous operation in fully submerged condition.

The motor shall be supplied with 25 metres of round submersible pre-insulated copper cable of appropriate capacity. The pump set shall be supplied with guide rail system with guide pipe of length suitable to the system, duck foot elbow suitable for delivery nozzle and non-return valve, dismantling joint etc. Including control panel with automatic start and automatic stop controlled by sewage levels in the suction well. Manual control shall also be provided.

Painting may be done as per relevant Bureau of Indian Standard Specifications.

TECHNICAL SPECIFICATION FOR NON-CLOG SUBMERSIBLE GRIT PUMP

MECHANICAL SPECIFICATION

General

The submersible grit pump shall be mono-block type with non-clog design. It shall be provided with agitator connected to the extended shaft to keep the silt in suspension. Pump shall be suitable to handle silt particles with specific gravity of 1.05. Pumps shall be of max. 1450 rpm. For ease installation, pump shall be provided with skirt base arrangement Submersible Motors have to be designed with maximum factor of safety to ensure non-overloading, while handling silt particles.

Impellers shall be of single/double vane non-clog design. Additionally, a special contra-block cutting and tearing system should also be incorporated on the suction side of the pump for disposing off soft material, which would otherwise clog the pump.

Maintenance free antifriction, permanently grease filled ball bearings shall be provided and this shall take care of all the axial and radial forces at any point of operation. The weights of the revolving parts of the pumps including the unbalanced hydraulic thrusts of the impellers shall be carried by thrust bearings provided in each pump assembly.

The reverse rotation prevention system shall be incorporated in the pump design to ensure that the pump does not start rotating in the reverse direction due to wrong electrical connection.

Pump Construction:

Pump Casing:

Pump casing shall be of CI as per IS 210 Gr FG 200 with 2.3% Nickel. The internal surfaces shall be free of rough spots. The casing shall have centerline discharge.

Impellers:

Impellers shall be of Stainless Steel (CFBM) construction. Impellers shall be of single/double vane Semi-open non-clog design. Additionally, a special contra-block cutting and tearing system should also be incorporated on the suction side of the pump for disposing off soft material, which would otherwise clog the pump.

Pump Shaft:

The pump shaft shall be of stainless steel (SS 410) as per manufacturers standard. The shaft shall be of single piece construction.

Pump Bearing:

Pump bearings shall be of the antifriction type. The bearings shall be able to take normal thrust loads due to unbalanced hydraulic loads on the impellers plus the weight of all rotating parts of the pumps. Pump bearings shall be designed with a minimum life of 40,000 hours. The bearings shall be grease lubricated for life, and shall be maintenance free.

Mechanical Seals:

Double mechanical seal shall be provided to prevent pumped liquid entering into the motor winding. The seal shall be situated in oil chamber to ensure proper lubrication. The face combination of lower mechanical seal shall be Silicon Carbide Vs Silicon Carbide and upper mechanical seal shall be Carbon Vs Chrome Steel.

Moisture Sensor:

Moisture sensor (seal monitor) shall be provided in the oil chamber to detect the failure of the mechanical seal. The sensor will trip the pump-motor in the event of ingress of moisture into the oil chamber.

Lifting chain:

Each pump shall be provided with carbon steel lifting chain of adequate strength. The chain shall have rings of same sizes as chain, fixed at an interval of about 1M for engaging the hook of the chain pulley block.

Foundation Nuts and Bolts:

S.S. Foundation nuts and bolts shall be provided.

Protective coating:

The pumps shall be epoxy painted

Pump Balance:

All rotating parts shall be statically and dynamically balanced as per the relevant standards.

Electrical Specifications:

Submersible Motor:

The submersible motor shall be dry, squirrel cage type, suitable for three phase supply, continuous duty, with class 'F' insulation. Winding of the motor shall be impregnated by resin. Motor shall have integral cable entry port and cable entry shall be properly sealed.

The pump motor may often requires starting after intermittent clogging. The motor should therefore incorporate aluminum die cast rotors only to ensure better starting torque characteristics. The enclosure for motor shall be IP-68. Each phase of the motors shall be provided with Thermic switches or bimetallic electromechanical temperature detectors. The motor shall operate satisfactorily at all operating levels in wet well.

Motor shall be sealed against entry of liquid being pumped by using two Mechanical seals.

3 MOTOR

3.1 TYPE OF MOTORS

The motors (suitable for submersible pump) shall be 415V AC squirrel cage induction motor with drip proof screen protected continuous rating. The motor shall be capable of working in the range of (380-440V) 3 phase 50 cycles at the speed of 1500 RPM.

OUTPUT OF MOTORS

The motor shall be capable of developing the mechanical output for the required conditions, shall have continuous normal rating to suit the maximum load when operated at the pump speed. The efficiency and power factor shall be to start the wide range of load conditions and shall be designed and manufactured in accordance with relevant BIS.

The motor HP shall be such that is should safely take the load when the total head is reduced by the rise of water level in rived during flood conditions in the rives. The HP of motor of offered shall have a margin 10% above the BHP absorbed by the pump set at duty point and also above the maximum HP absorbed by the pump offered.

4. SPARE PARTS

Supply of spares and tools shall be made as per the list prescribed in BOQ with index card.

5. TOOLS

Standard tools for the maintenance of the equipment shall be supplied as detailed.

| | | |
|--|---|--------|
| | D/E spanners | 1 set |
| | Ring spanners | 1 set |
| | Bearing puller | 1 No |
| | Grease gun | 1 No |
| | Hand gloves tested for electrical operation | 1 Pair |
| | Ball peen hammer | 1 No |
| | Screw Drivers | 1 set |
| | Electrical tester | 1 No |
| | Electric megger | 1No |

6. COMPLETION PLANS

The successful bidder shall be requested to furnish completion plans in triplicate within one month from the date of the first testing of the plants. The plan should show the entire layout of the plant executed. Two copies of plan should be supplied to the Employer and one to be framed and suspended in the Head works. The contractor shall in addition to the above furnish detailed specifications of the equipment provided to the Employer with all technical data.

7. MAINTENANCE MANUAL

The periodical maintenance schedules for each equipment shall be given with reference to the hours of operation. Detailed information about the spare parts (part name, identification number etc.) should be given. The copies of the manuals should be furnished within one month from the date of commissioning.

8 The contractor should supply one set of tools for the pump set maintenance of the machinery and equipment supplied by them under this contract.

9 The contractor has to operate and maintain the pump sets and other machinery and equipment for a period of 30 days to the entire satisfaction of the Engineer, free of cost, unless otherwise specified. Fuel lubricants and power supply if required will be supplied free of cost, for operation and maintenance during that period.

10. For machinery and equipment, the payment will be made at 75% of the value of equipment brought to the site. The balance payment for these items will be made after erection and commissioning. In each of these cases 5% of each bill amount will be withheld as retention money as mentioned in clause 54 of section II Part I General stipulations and conditions.

11. The contractor should supply immediately after commissioning three sets of operations and maintenance manuals for all equipment and machinery supplied under this contract.

12 General

12.1 Cable lengths given are only approximate and payment will be made for the actual lengths of cable laid.

12.2 The contractor has to make necessary arrangements to get supply of electricity from CESU for operating the machinery and equipment. The necessary service connection and S-D charges will be paid by the Board.

12.3 The Contractor should obtain all approvals for the installation and commissioning of machineries and accessories offered by them from the respective inspecting authorities etc. Fees if any, to be paid to the inspecting authorities will be reimbursed by the Board.

12.4 Before supply of the machinery equipment and other materials, prior approval of the Engineer should be obtained giving the name of maker and other details required.

13 Electrical Wiring and installation of fittings

13.1 The materials used for conforms to the relevant I.S.S wherever applicable. The make and other details of materials to be used should be furnished along with the tender.

13.2 Continuous earth connection are to be made with 14 SWG T.C. wire.

13.3 The wiring work done shall be neat, true to line, level etc. and in such a way that it gives an impressive and aesthetic appearance to the building.

13.4 The actual location and number of points for lights, fans power plugs etc. may be altered at the time of execution by the Engineer.

13.5 Entire wiring and cabling work should be done as per IE rules.

13.6. Any damages or breakages, chipping etc. caused by the electrification works to the structures have to be rectified by the contractor at his cost to the satisfaction of the Engineer.

13.7. The Contractor has to test and every point after completion of wiring to the entire satisfaction of the Engineer by taking temporary supply from the existing service.

13.8. Wiring to light point (both internal and external) and fan point will be treated as complete only when supply as well as connection up to the ceiling rose is completed.

13.9. Whenever conduit pipe wiring is done, cover for switch boards containing switches, plugs, etc. should be of hylam sheet or other specified sheet only.

IX. ANNEXURES

- I. Pump characteristics
- II. a) Turbine pumps
b) Motor for turbine
- III. a) Centrifugal pump.
b) Motors for Centrifugal pump.
- IV. a) Submersible pump
b) Motors for submersible pump
- V Starters

(The above annexures as applicable should be filled in and duly signed and enclosed with the Technical Bid – Cover I)

Note: The make of the pumping machineries and accessories should be as specified in Chapter VIII Pump set and accessories part 10. If the said makes are not available, then only equivalent should be considered with prior approval of the Executive Engineer concerned.

ANNEXURE – I

PUMP CHARACTERISTIC

| Sl. No. | Description | Technical Details | Remarks |
|---------|---|-------------------|---------|
| a. | Capacity in LPM (Discharge) | | |
| b. | Total head in metres | | |
| c. | Net positive suction head required | | |
| d. | HP absorbed by the Pump | | |
| | i) at duty point ii) at max BHP point given in the range of curve furnished. | | |
| e. | HP of the motor offered | | |

Note:

1. The motor must not get over loaded, at Positive low head Conditions due to Maximum W.I. Conditions in Bore well/well.
2. The make of the pumping machineries and accessories should be as specified in Chapter VIII Pump set and accessories part 10. If the said makes are not available, then only equivalent should be considered with prior approval of the Executive Engineer concerned.

ANNEXURE - II (a)

Submersible Pump sets (Non-clog)

01. Name of the Manufacture :
02. Type of pump and Model :
03. Number of sages :
04. Material of strainer :
05. Delivery Branch dia (in mm) :
06. Total discharge in LPM :
07. Materials of casing :
08. Type of impeller ;
09. Materials of impeller ;
10. Material of impeller shaft :
11. Type of bearing ;
12. Are the bearings external or internal :
13. Materials of bearing :
14. Maker's name and code number of bearings :
15. Whether moving parts are balanced :
16. If so type of balancing :
17. BHP of the pump ;
18. Efficiency of the pump :
19. Weight of the pump :
20. Diameter of the pump :
21. Pump speed :
22. Are the characteristics curves of the pumps attached :
23. Total head :
24. Does the pump confirm to BIS specification :
25. Specification reference :
26. What is the nature of the drive :
27. Type of the coupling :

28. Weight of the heaviest part of the pump :

29. Weight of the pump complete :

ANNEXURE – II (b)
Motors for Submersible Pump sets (Non-clog)

1. Name of the manufacturer :

2. Type of Motor :

3. Brake Horse Power of the motor :

4. Number of phases :

5. Cycles :

6. System Voltage :

7. Frequency :

8. Speed at full load :

9. Full load current

a) Normal full load Amps
b) Maximum starting Amps

| | | | |
|----------------|------------------------|---------|-------------------------|
| 10. Efficiency | Load | Percent | Tolerance as per BIS |
| | Full 3 / 4 1 / 2 | | |

11. Overload capacity

- a. 25%
- b. 50%
- c. 100%

| | | | |
|------------------|------------------------|---------|--------|
| 12. Power factor | Load | Percent | as per |
| | Full 3 / 4 1 / 2 | | |

13. HP of the Motor :

14. Number of poles :

15. Type of enclosure :

16. Type of Rotor :

17. Bearing manufacturer :

18. Type, number and size of bearing
(Driving end) :

19. Size of coupling and its type :
20. Does the Motor conform to BIS specification :
21. If so state the No. :
22. Weight of Motor :
23. Total weight of pump and Motor :
24. Diameter of the Pump set :
25. Overall efficiency of the pump set :

Note: The make of the pumping machineries and accessories should be as specified in Chapter VIII Pump set and accessories part 10. If the said makes are not available, then only equivalent should be considered with prior approval of the Project Engineer concerned.

ANNEXURE –III

Starters

1. **Name of Manufacturer** :
2. Type of starter :
3. Type of cooling :
4. Over load relay :
5. No Volt coil :
6. No. of starters permitted in one hour :

Note: The make of the pumping machineries and accessories should be as specified in Chapter VIII Pump set and accessories part 10. If the said makes are not available, then only equivalent should be considered with prior approval of the Executive Engineer concerned.

X. SEPTAGE TREATMENT PLANT

SEPTAGE MANAGEMENT AT BHUBANESWAR IN KHORDHA DISTRICT

PROCESS OF SEPTAGE TREATMENT PLANT METHODOLOGY

PROCESS DESCRIPTION OF SEPTAGE TREATMENT PLANT

The septage management involves collection, transportation, treatment and disposal of septage and subsequent disposal of treated and stabilized sludge.

The septage collected from the septic tank will be transported to the proposed Treatment site. 75 m³ of volume of septage will be collected per day.

The septage treatment technology to be adopted has been selected based on the guidance provided in the GoI, Ministry's Guidance Note on Septage Management and available fact sheet in the literature for the subject on Faecal Sludge Management. The choice of an appropriate septage management system is dependent on land availability, hauling distance, technical requirements, and availability of skilled labour, legal and regulatory requirements.

Treatment Technology:

Based on the guidance and local circumstances, settling cum thickening tank has been proposed for solid-liquid separation process and sludge drying beds for septage dewatering. The filtrate from the sludge drying beds will be treated in DEWATS along with the sludge supernatant. The filtrate from the horizontal Planted Gravel Filter will be treated in maturation pond for tertiary treatment. The treated effluent conforming to OPCB effluent standards as prescribed in OPCB Ir.no: 8436/CON-ULB-341/2015-16 dt.20-05-2016 will be either reused in the nearby parks for water purpose or within the septage treatment facility where HRTS is proposed to be installed. However, effluent in excess of such requirements shall be discharged to nearby water bodies which will be decided as per existing field condition.

INLET AND OUTLET SEWAGE CHARACTERISTICS

| A. Raw Septage Characteristics (based on sample test conducted by EIL, average value of three samples) | Value | Unit |
|---|--------------|-------------|
| pH | 6.58 - 7.07 | |
| Biochemical Oxygen Demand | 1400 – 2940 | mg/lit |
| Chemical Oxygen Demand | 7250 – 14800 | mg/lit |
| Total Suspended Solids | 720 – 1890 | mg/lit |
| B. Treated Septage effluent characteristics | | |
| pH | 6.5 – 9.0 | |
| Bio Chemical Oxygen Demand | ≤ 10 | mg/lit |
| Total Suspended Solids | ≤ 20 | mg/lit |
| Chemical Oxygen Demand | ≤ 50 | mg/lit |

INTERNAL ROADS, PATHWAYS AND GREEN BELT DEVELOPMENT

The entire Septage treatment plant will be provided with 4 m wide Concrete Road Storm water drain, Culvert crossings and pathways etc., The premises of STP will be developed with adequate green belt programme. The gardening will be done through the treated effluent to maintain sufficient green belt all around the STP.

XI. TESTING, ERECTION, TRIAL RUN, COMMISSIONING AND ACCEPTANCE

1 General

This part deals with specifications for - Erection, testing, recommissioning, commissioning and acceptance.

1.1 Test Instruments

The contractor shall satisfy the Engineer as to the accuracy of all the instruments used for tests and if required shall produce recent calibration tests, otherwise have them calibrated at his own expense by an independent authority.

2 Test Certificate

Copies of certificates of all works hydraulic tests shall be provided as detailed.

The contractor shall obtain and submit to the Engineer and to other parties as may be directed, certificates of test of all times, certifying that they have been satisfactorily tested and giving full particulars of such tests.

3 Hydraulic Test

All equipment subject to water pressure including casting, pressure vessels, pumps, pipes, fittings, and valves, shall be hydraulically tested to the pressure specified or in accordance with the applicable standard or to at least 1.5 times the maximum working pressure, whichever shall be the greater. Hydraulic test shall be given at the manufacturer's works.

Any of the hydraulically tested items shall be subject to the Engineer's / inspector's random item proof re-test and notice of testing dates shall be submitted to the engineer.

Unless otherwise specified hydraulic tests to 1.5 times the maximum working pressure shall also be applied at site to all pipework installed by the contractor.

4 Manufacturer's works inspection tests and guarantees

All schedules of particulars shall be completed and the guaranteed particulars and the efficiencies of the equipment offered at the duties specified will be binding and may not be varied except with the consent in writing of the Engineer.

The Engineer shall be provided with the facility for inspection of all equipment and material and shall be given at least 30 days' notice when such equipment or material is ready for inspection of works test.

Full witness testing to the relevant standards and to prove guarantees given will be required for the following items:

- i. All pumps
- ii. Electric motors
- iii. All control panels
- iv. All circuit breakers
- v. All transformers
- vi. All lifting equipment
- vii. Cables
- viii. All process control and indicating instruments
- xi. All electrical measuring instruments and meters
- x. Flow measuring equipment and gauges.

In addition, all other items of equipment not subject to witness testing shall be temporarily erected at the manufacturer's works and tested for satisfactory operation and shall be offered for inspection. Copies of manufacturer's test readings shall be submitted to the Engineer, all prior to packing for shipment. Such inspection, examination, or testing, shall not release the contractor, manufacturers or supplier of any item from any obligation under the contract.

Certified copies of manufacturer's test readings of all items shall be submitted to the engineer within 7 days of the satisfactory completion of the test.

Whilst the engineer shall be provided with facilities for witness testing and/or inspection of all items of equipment at the manufacturer's works. He may at his discretion advise that the test shall proceed in his absence. These test shall be made as if in his presence, and duly certified copies of test readings shall be submitted.

Where items of equipment are of identical sizes and duty it may be required, at the Engineer's discretion, that a reduced number of the items be subjected to witness test; however, this shall not relieve the manufacturer from the requirement of carrying out the performance tests on all items prior to offering a witness testing.

If after inspecting, examining or testing any material or equipment, the Engineer shall decide that such items or any part thereof is defective, or not in accordance with the specification or performance requirements, he may reject the said items or part thereof, giving to the manufacturer within a reasonable time, notice in writing of such rejection, stating therein the ground upon which the said decision is based. All re-testing shall be at the contractor's expense.

5 Site Testing

The Contractor shall arrange for the full site testing of all items of equipment and shall include Provision of:

- a. All skilled and qualified operating and test staff for the testing of all equipment.
- b. Provision and disposal of all services, lubricants, and fuels other than electricity
- c. All measuring and testing instruments to demonstrate equipment operates to the fulfillment of the works test
- d. All loading weights for the load testing of all lifting equipment

All test shall be carried out by the contractor to the approval of the Engineer.

The Contractor shall be responsible for coordinating the programme of site testing of all items and to ensure that all parties concerned are present during any tests to obligate their responsibilities.

Manufacturer's Works Tests

6 Pumping Plant

Pumping plant shall be tested as follows:

1. Each pump shall be tested individually in accordance with part I of BS 5316. Site conditions shall be simulated as near as possible particularly the minimum site NPSH condition.
2. Each pump shall be tested complete with all shaft bearings, thrust bearings and directly driven auxiliaries or, where this is impracticable, the contractor shall state what allowances shall be made for losses incurred by these items, and shall demonstrate the accuracy of these allowances to the satisfaction of the Engineer.

3. Each pump shall be tested with its own motor wherever feasible. It shall be tested particularly at the guarantee performance duty point and over its full working range where possible from its closed value condition to 30% in excess of the guaranteed quantity or minimum head. Head/quantity curves and overall efficiency/quantity curves shall be plotted to demonstrate that the plant will be capable of meeting the full range of operating conditions at site.
4. Pump casings shall be subject to pressure test at 1.5 times the maximum pressure obtained with the delivery valve closed. The positive suction head shall be taken into account in determining this pressure.

7 Cranes

All crane lings and lifting beams shall be tested at the manufacturer's works with a load 25% in excess of the rated load. Tests shall include measurement of deflection and speed of lifting etc.

The test shall be repeated at site when erection is complete using test weights to be provided under the contract.

Certificates shall be provided for both tests.

8 Valves

All valve bodies shall be hydraulically tested closed ended to 1.5 times the rated pressure. Isolating valve seats shall be tested to the maximum working pressure, at which pressure they shall be drop tight.

9 The contractor shall include for all necessary tests as laid down in the specification and those required in order to comply with the relevant Indian standards as follows;

a. Power Transformers

- i. Measurement of winding resistance
- ii. Ratio polarity and phase relationship
- iii. Impedance voltage
- iv. Load losses
- iv. No-Load losses and no-load current
- v. Insulation resistance
- vii. Induced over voltage withstand
- viii. Separate source voltage withstand.

Type test:

- i. Impulse voltage withstand both chopped and full wave
- ii. Temperature rise.

Unless otherwise stated by the Engineer, evidence of type of tests carried out on identical transformers to those being provided under the contract will be accepted in lieu of actual tests.

b. Circuit breakers and control gear;

- i. Routine tests including H.V. pressure test, mill-volt drop (Doctor) test;
- ii. To ensure operation of the closing child and satisfactory closing of the circuit breaker with the voltage on the coil down to 80% of its rated voltage, and that mal-operation does not occur with a voltage on the coil of 120% of the rated voltage.

- iii. To ensure the satisfactory trip operation of the circuit breaker at no load conditions with the trip coil energized at 50% of its rated voltage.
- iv. The test figures for heat-run tests performed on identical panel types shall be made available.

c. Protection and control circuits

Based on the completeness of the circuits in the final manufactured form within the manufacturer's works, the following tests shall be carried out:

- i. Primary in injection test to ensure correct operation of the current operated protection relays and direct acting coils over their full range of setting.
- ii. balanced earth fault stability tests by primary current injection. Care must be taken to reproduce accurately the burdens of interconnecting cables. A further test to ensure correct polarity must be made after assembly.

With differential pilot wire schemes it may not be possible to apply primary injection testing. In this case the circuits shall be proved by secondary injection. Current transformer characteristics and calculations associated with the above tests shall be available for inspection by the engineer.
- iii. Tests on auxiliary relays e.g. Buchholz auxiliary, at normal operating voltage by operation of associated remote relays.
- iv. Correct operation of control circuits at normal operating voltage by operating voltage by operation of local control switches, and simulation of operation from remote control positions.

d. Motors

Motors over 22 KW site rating shall be subject to full performance test which may be witnessed by the engineer at the motor manufacturer's works.

Motors of 5.5 KW to 22KW site rating shall be subject to performance tests but will not be witnessed.

Motors under 5.5 KW site rating shall be subject to type test standards.

Type test certificates which shall include the following shall be provided for all motors;

- i. Manufacture to BIS/IS.
- ii. Class of insulation
- iii. Type of cable fittings.
- iv. Type of bearing size and lubricant.
- v. Type of and rating of motor heaters.

Motor testing shall be carried out in accordance with the requirements of BIS.

e. Instruments and Meters

Tests to ensure operation of all ammeters, voltmeters and transducers and checks for correct calibration. Kwh meter shall be changed for correct rotation and creep test shall be carried out to ensure that the meter is inoperative with voltage along, of the secondary of the current transformer is left connected with the primary Corinthian erupted.

10 Test on Cables During Manufacture

All cables supplied under the contract shall be subject to routine tests in accordance with the relevant British standard. Cables will not be accepted on site for installation until certificates giving proof of compliance with the specification and date of tests have been received and approved by the Engineer. A certificate shall be applicable to each drum.

The tests to be carried out on every drum at manufacturer's premises shall include:

- a. High voltage A.C. insulation pressure test between cores, each core to earth metallic sheath or amour as applicable
- b. Insulation resistance test
- c. Core continuity and identification
- d. Conductor resistance test.

11 Process Control and Indicating Instruments

All flow, level process measurement controllers, transmitters, recorders, indicators, vacuum and pressure gauges shall be subject to routine in accordance with BIS.

Test certificate shall be provided against each item of equipment.

12 Electrical measuring Instruments and Meters

Test to ensure accurate operation of all meters, voltmeters and kwh. Meter shall be undertaken in accordance with IS:9319.

13 Alarm systems

The contractor shall be responsible for testing all items of equipment comprising the works alarm system for correct operation and sequence action.

14 Site Tests

Leakages tests at the test pressure shall be carried out aeon all enacted pipe work and values immediately after erection and before being built in. The contractor shall advise the Engineer when these tests are to be carried out.

15 Tests on Cables During Installation

During the period of site installation, the Engineer will carry out inspection of the works tonsure the standards of workmanship meet the specification and are to his satisfaction. In the event of any part of the cabling installation failing to meet these requirements the contractor shall remedy the deficiency to the satisfaction of the Engineer.

After completion of various parts of the installation the contractor shall provide a test engineer, labor and materials to demonstrate to the engineer that the cables have been correctly installed.

The contractor shall inform the Engineer prior to the testing of cables and shall be responsible for liaison with any other contractor to whose equipment the cables may be terminated to ensure all parties concerned are aware of the impending tests, to guarantee safety of personal and that isolation of any particular equipment has been completed. Any special isolation or preparation required to be carried out before cable testing will be completed by the contractor responsible for that equipment. The contractor to the satisfaction of the Engineer shall carry out all tests.

16 Pump Sets

Tenderers shall complete the schedule of particulars and guarantees and shall state therein, inter alia, the guaranteed efficiencies of the pumps and motors offered, and the overall guaranteed rates of energy consumption of the complete pump sets at the duties specified.

The contractor's guarantees given when tendering in respect both of performance and efficiency shall be binding and considered part of the contract.

The fulfillment of these guarantees shall be verified at the works test and at site trials in accordance with the procedure given in Indian standards specification etc.

The site trails shall be carried out under the control of the contractor's staff to the satisfaction of the engineer. The contractor shall provide all the necessary labor and instrumentation to conduct the tests. The discharge from the pumps shall be measured using a portable ultrasonic flow meter.

17 Electrical plant

After all the deficiencies apparent during the installation inspection have been rectified to the engineer's satisfaction, the following tests shall be carried out:

- a. Power transformers: i. Dielectric tests on insulating oil to IS: 566.
- b. Circuit breakers and control gear: i. Routine tests, including H.V. pressure tests
- c. Protection and control circuits

Tests at 8.9(a), (b) (c) with the addition of satisfactory operation of all inter- tripping circuits in connection with other items of plant.

18 Tests on Cables after Installation:

Every cable shall be subject to the following tests after installation: - High voltage pressure tests:

The following D.C. test voltages shall be applied at full value: -

| | | |
|----|---------------------------|-------------------------------------|
| 1. | PLYSWS | 11,000 volt grade cable |
| | Between cores | Between any cores and armour |
| | 30,000 volts | 17,500 volts |
| 2. | XLPE SWAPVC.C | 3,300 Vet grade cables |
| | Between cores | Between any core and armour |
| | 10,000 v | 5,8000v |
| 3. | XLPE SWAPVC or PVC SWAPVC | 1,100 volt grade mains cable |
| | Between cores 3,000 v | Between any core and armour 3,000 v |

Witnessed high voltage pressure tests shall not be carried out on PVC/SWAPVC control cables, but it shall remain the responsibility of the contractor to test the insulation of these cables both between core and between cores and earth during installation with a 'Megger' 500-volt hand generator.

The contractor shall test all cables after installation to ensure correct phasing out of cores, continuity of cores sheath and armour over the whole length of the cable.

19 Earthling system Tests

The contractor shall demonstrate to the Engineer that the resistance of the electrodes to earth and the earth conductor continuity is in accordance with the specification. The tests shall be made on completion of the installation.

The test shall be performed for each major item of plant, by using an Earth Meager and auxiliary return conductor.

20 Testing pipelines

General

Pipelines shall be tested in lengths between manholes or valve pits or such shorter lengths as the Engineer may direct or permit.

Pipelines shall be tested in the presence of the Engineer.

Fittings required for temporarily closing openings in pipelines to be tested shall be properly designed for this purpose and shall be adequately strutted to withstand the test pressure specified.

The arrangements for testing a pipeline shall include provision for the surging of air from the pipeline prior to a water test.

The contractor shall keep a record of all tests in a book which shall be available for inspection and handed over to the Engineer on demand.

21 Testing pressure pipelines

Each pressure pipeline shall be tested after completion with the exception of any backfilling not necessary for the stability and safety of the work.

Prior to the testing of a pressure pipeline valves shall be checked and sealed. The pipeline shall then be filled with water and the air released. After having been filled the pipeline shall be left under operating pressure for at least 24 hours so as to achieve conditions as stable as possible for testing.

The pressure in the pipeline shall then be raised steadily until the test pressure of 50% excess of the maximum working pressure is reached in the lower part of the pipeline and the pressure shall be maintained at this level by pumping if necessary for a period of one hour. The pump shall then be disconnected and no further water shall be allowed to enter the pipeline for a period of one hour. At the end of this period the original test pressure shall be restored by pumping and the loss measured by drawing off water from the pipeline until the pressure as at the end of the one-hour test period is again reached.

The permissible loss for pressure pipelines under test shall not exceed 20 liters per nominal bore per kilometer length per bar of pressure (Calculated as the average pressure applied to the pipeline) per 24 hours.

Gauges used for testing pressure pipelines shall have a dial diameter of not less than 150 mm and a full-scale reading not greater than twice the specified test pressure. Before any gage is used the contractor shall arrange for it to be checked independently and a data certificate of its accuracy shall be provided for the Engineer.

The contractor shall make his own arrangements for the supply and disposal of water used for testing which shall be obtained from a source approved by the engineer.

22 Test on Instruments

The contractor shall carry out on-site pre calibration test to demonstrate the accuracy of all level, pressure at rate of flow instruments, the transducers, buffers, displays amplifiers, recorders, integrator and transmitters incorporated in the works over a range of flow from the minimum to the maximum anticipated design range in the plant as required by the specification and that the accuracy obtained at the manufacturer's works tests can be obtained on site. The contractor shall supply sets of calibration curves of weirs, flow meters, metering pumps and the like.

23 Other tests

The contractor shall carry out all other tests required either by himself and or the engineer to prove the plant, and to comply with the requirements specified.

These tests shall embrace all instrumentation, alarms, control systems and processes, all pumps, chemical metering devices, feeders, robes, gages and other components of the plant over the full range of operating conditions.

If, in the opinion of the engineer, any item of plant is irreparable or insufficient for its purpose or function the contractor shall, without delay, replace the item with another satisfactory item or better unit all at his own cost, paying if necessary, air freight charges to expedite prompt delivery.

24 Erection - General

a. The contractor's staff shall include at least one competent erection engineer with previous, suitable, previous experience on similar contracts to supervise the erection of the works and sufficient skilled, semiskilled and unskilled labor to ensure completion of the works in time. The contractor shall not remove any representative, erector or skilled labor from the site without the prior approval of the Engineer's Representative.

b. One erection engineer who shall be deemed to be the contractor's representative shall be conversant with the erection and commissioning of the complete works. Should there be more than one erector, one shall be in charge and contractor shall inform the Engineer's Representative in writing which erector is designated as his representative and he is in charge. Erection engineer is to report to Project manager.

c. The contractor's erection staff shall arrive on the site on date to be agreed by the engineer's Representative before they proceed to the site, however, the contractor shall first satisfy himself, as necessary, that sufficient plant of his (or his subcontractor's) supply has arrived on site so that there will be no delay on this account.

d. The contractor shall be responsible for setting up and erecting the plant to the line and levels of reference given by the engineer in writing, and for the correctness (subject as above mentioned) of the positions, levels dimensions and alignment of all parts of the works and for provision of all necessary instruments, appliances and labor in connection therewith. The checking of setting out of any line or level by the engineer or engineer's representative shall not in any way relieve the contractor of his responsibility for the correctness thereof.

e. Erection of plant shall be phased in such a manner to as not to obstruct the work being done by other contractors or operating staff who may be present at the time. Before commencing any erection works the contractor shall check the dimension of structures where the various items of plant are to be installed and shall bring any deviations from the required positions, lines or dimensions to the notice of the Engineer. Plant shall be erected in a neat and workmanlike manner on the foundations and at the locations shown on the approved drawings. Unless otherwise directed by the Engineer, the contractor shall adhere strictly to the aforesaid approved drawings. If any damage is caused by the contractor during the course of erection to new or existing plant or buildings or any part thereof, the contractor shall, at no additional cost to the employer, make good, repair or replace the damage, promptly and effectively as directed by the Engineer and to the engineer's satisfaction.

f. During erection of the Plant the Engineer will inspect the installation from time to time in the presence of the contractor's site representative to establish conformity with the requirements of the Specification. Any deviation and deficiencies found or evidence or unsatisfactory workmanship shall be corrected at instructed by the Engineer.

25 Leveling and grouting of Machinery

a. Contractor shall check the civil works, where the plant is to be installed sufficiently in advance. For their conformity to the approved drawings for installing the plant with respect to lines, levels and accuracies of position embedment, anchorage pockets, cutouts etc. and he shall record all measurements and deviation in prescribed control formats. He shall proceed with the works, with the Engineer's approval of civil works for undertaking of installation of the plant consequent to such preparatory inspection or work.

b. Contractor shall mark precisely the centerline and datum reference on the civil works. Where the plant is to be installed with reference to bench marks, using indelible means of marking.

c. He shall undertake sufficiently in advance chipping of any unevenness of concrete on foundations, anchor bolt pockets, cutouts etc. to achieve uniform level of reference for erection.

d. All concrete surfaces receiving grout shall be hacked at 35 required to ensure better bonding with grouting.

e. Contractor shall undertake the inspection of all components to be erected sufficiently in advance to check their soundness and conformity to drawings and the inspection records shall be signed by the engineer as approval for undertaking the installation of the components. Any damage, shortfalls etc. Shall be made good to the satisfaction of the engineer.

f. All grout for equipment shall be carried out using non-shrinkable continuous grout materials with suitable from work of at least 12 mm thickness. Surfaces to receive the grout be hacked and roughened and laitance shall be removed by wire brushing or blast of air. Concrete surface shall be blown off by compressed air before commencing grouting. Grouting shall be done in one continuous operation from one side such that grout flows in a single ware until grout reaches all confined spaces with no air pockets and air from all confined spaces is expelled. A hydrostatic head of 150 mm shall be maintained during grouting operations. All grouting shall be carried out in the presence of the Engineer's Representative. All manufacturer's recommendations. All lines levels shall be checked up after grout is set, block outs shall be closed using cement concrete of the same grade as that of the parent structure.

26 Completion of Erection

- a. The completion of plant under erection by the contractor shall be deemed to occur, if all the units of the plant are structurally and mechanically complete and will include amount other such responsibilities the following:
 - i. Plant in the scope of the contractor has been erected, installed and grouped as per specification.
 - ii. Installation checks are completed and approved by the engineer.
 - iii. The erected plants are totally ready for commissioning checks.
- b. At the stage of completion of reaction, the contractor shall ensure that all the physical, aesthetic and workmanship aspects are totally complete and the plant is fit and sound to underage commissioning check/test on completion.
- c. Upon achieving the completion as described above, the contractor shall notify the engineer by a written notice intimating such mechanical completion of units and notify the engineer for inspection and acceptance of mechanical completion. The engineer/Engineer's Representative shall proceed with the inspection of such units within 14 days of such a notice thereafter:
 - i. The Engineer shall certify completion when there are no defaults in the works and the plant is acceptable or
 - ii. The Engineer shall inform the contractor list of deficiencies for rectification hereinafter referred as punch list and the contractor shall complete the rectification work within a jointly agreed period before tests on completion and obtain the Engineer's acceptance or approval of the same before proceeding with the tests of completion or
 - iii. The Engineer may inform the contractor that the works are accepted with the `punch' list (Items which do not hamper operability, safety or maintainability) and allow the contractors to proceed with the pre-commissioning checking following by test on completion when the contractor under takes to complete such outstanding works within an agreed time during defects liability period.
- d. Taking over shall be based on rectification of all deficiencies as advised by punch lists.
- e. The erection period indicated by the contractor would be deemed to cover all the activities upon completion as stipulated in previous paragraphs, notice of completion by the contractor, inspection by the Engineer for completion, and contractor rectification of all deficiencies as noticed by the deficiency/punch list, and acceptance by the Engineer of such rectification's, prior to test on completion.
- f. Minor defects, which in the opinion Engineer which do not hamper operability and main ability will not be taken into account for deciding mechanical completion. Such defects shall be rectified concurrent to commissioning checks before tests on completion. However, the engineer's decision in this regard is final.
- g. The commissioning period as notified by the contractor shall be deemed to occur beyond the date of completion and shall include all periods of pre-commissioning, trails and tests on completion.

- h. It is in the contractor's interest to offer the sections/units/systems, progressively under identified milestones within overall erection period, duly completed for inspection by the Engineer's Representative, obtain his "punch" list, for rectification of any deficiencies pointed out by the Engineer and to achieve mechanical completion before undertaking the tests on completion within the specified erection period. The engineer also reserves a right to withhold the cost, as estimated, to be equivalent to the rectification of deficiencies pointed out to the contractor until such a time such deficiencies are rectified to the satisfaction of the engineer.

27 Installation Inspection

In addition to the progressive supervision and inspection by employer the contractor shall offer for inspection to Engineer, the completely created plant/part of plant on which tests are to be carried out. After such inspection by engineer, each equipment/sub system shall be tested by the contractor in accordance with the applicable standards in the presence of Engineer. Such tests shall include but not be limited to the test specified in following clauses.

a. Pumps, Piling and Valves

- i. The erected pipe work shall be subjected to a hydraulic test at 1.5 times the maximum pressure of twice the working pressure whichever is higher to test the soundness of the joints, provision of the necessary pumps, gages, blank flanges, tapping etc. for carrying out these tests shall be included in the contract.
- ii. Leakage test shall be carried out on all erected pipe work, pumps and valves immediately after erection and where possible before being built in.
- iii. Operating tests shall be conducted on valves.
- iv. The pump set shall be tested for satisfactory operation. The vibration and noise level shall be checked to be within the specified limits.

b. Pump motors

Condition of winding insulation be tested and Insulation valves shall be restored to required level by suitable heating arrangements locally.

c. Cranes and hoists

The crane and lifting tackle shall be tested to 125 % of the safe working load. The contractor shall arrange the test load.

d. Screen

After erection, the screen shall be tested for its performance for checking its capability to handle stringy materials. Clearance between the dead plate and tiles shall be checked.

e. Sluice Gate

- i. The contractor shall perform leakage test after installation of the sluice gates.
- ii. Under the design, seating head and unseating head the leakage shall not exceed the limit specified an AWWA 0501/IS; 13319, class I for shop testing.

f. Instrumentation and control system

Performance of the instrumentation system and function of logic control system shall be checked as per the design requirements.

28. Recommissioning Trials, Tests

a. Start up:

On completion of erection of the equipment and before start-up, each item of the equipment shall be thoroughly cleaned and then inspected jointly by the Engineer and the contractor for correctness, completeness of installation and acceptability for startup, leading to initial pre-commissioning test at site. The Engineer and contractor shall as mutually agree the list of pre commissioning tests to be performed.

b. Trial Operation

The contractor shall prepare a Trial operation report comprising of observations and recordings of various parameters to be measured in respect of the above trial operation. This report, besides recording the details of the various observations during trial run shall also include dates of start and finish of the trial operation and shall be signed by the representatives of both the parties. The report shall have sheets, recording all the details of interruptions occurred, adjustments made and any minor repairs done during the trial operation. Based on the observations, necessary modifications /repairs to the plant shall be carried out by the contractor to the full satisfaction of the engineer to enable the latter to accord permission to carry our performance and guarantee tests on the plant. However, minor defects, which do not endanger the safe operation of the equipment, shall not be considered as reasons for withholding the aforesaid permission.

29 Commissioning

- i. The plant shall then be on trial operation of Ninety days during which period all necessary adjustments shall be made while operating, over the full load-range enabling the plant to be made ready for performance and guarantee tests. The contractor shall provide necessary staff. The trial Operation shall be considered successful, provided that each item of the equipment can operate continuously at the specified characteristics, for the period of Trial Operation.
- ii. During the contractor's commissioning/start-up engineers specifically identified as far as possible, shall be responsible for carrying out all the pre-commissioning tests. On completion of inspection, checking and after the pre-commissioning tests are satisfactorily over, the complete plant shall be placed on initial operation during which period the complete equipment shall be operated integral with sub-systems and supporting equipment as a complete plant.
- iii. Any special equipment, tools and tackles required for the successful completion of the performance and guarantee the contractor free of cost shall provide Tests.
- iv. The contractor during the performance and guarantee tests shall provide the guaranteed performance figures of the equipment. Should the results of these tests show any decrease from the guarantee values, the contractor shall modify the equipment as required to enable them to meet the guarantees. In such case, performance and guarantee tests shall be repeated within one month from

the date the equipment is ready for re-test and costs for modifications including labor, materials and the cost of additional testing to prove that the equipment meets the guarantees, shall be borne by the contractor.

Performance and guarantee tests shall make allowance for instrumentation errors as per specification.

30 Acceptance

- a. The employer will certify no item of plant for acceptance unless it has successfully passed the entire test called for under the contract. If nevertheless the employer uses only
- b. Part of the works, that part which is used shall be deemed to have been accepted at the date of such use.
- c. An acceptance certificate for plant shall not be issued unless the following documentation are duly compiled and submitted in final formats in duly bound volumes.
 - i. A compilation of all shop inspection results/reports of the plant/machinery with due attestation that the plants have been manufactured to specified standards (6 copies).
 - ii. All erection/ construction quality control checks in appropriate approved formats for all installation works with attestation that installation has been carried out as per acceptable/stipulated standards (6 copies)

On completion of the trial operation, it is the sole responsibility of the contractor to maintain the entire project successfully for the Trial run period of 3 months.

XII. MINIMUM ENVIRONMENTAL MANAGEMENT MEASURES

The EIA and EMP is to be adhered during construction and Operation and maintenance period by the Contractor

Environmental Assessment

1. Objectives and Need

Objectives of this assignment are to:

establish the environmental baseline in the study area;

identify and assess the adverse environmental impacts;

provide requisite measures to address these impacts;

identify the opportunities for environmental enhancements in the project area and provide requisite guidance/plans in this regard;

wherever relevant integrate the measures (mitigation and enhancement related) in the project planning and design; and

develop appropriate management plans and codes of practices for implementing, monitoring and reporting of the environmental mitigation and enhancement measures suggested.

The EIA shall be carried out in line with the Government of India (GoI)'s regulations. The EA comprises: Environmental Screening, Project EA and the Environmental Management Plans (EMPs). The EA shall be carried out in a consultative manner through "Stakeholder Consultations", at various stages, with the affected communities, NGOs, selected government agencies and other stakeholders.

2. Scope of Work

The following are the tasks to be performed by the contractor while conducting Environmental Assessment for the STP including nature, scale and magnitude of impacts that the project is likely to cause on environment.

Task 1: Description of Project

A succinct description of the proposed project shall be provided.

Task 2: Review of Earlier Studies

The contractor shall review various earlier studies such as feasibility and detailed project reports, etc., of the project and understand the project and various aspects associated with the same. This shall provide a base to formulate the environmental surveys necessary for the project and assessing impacts of the same.

Task 3: Legislative and Regulatory Considerations

A review of the legal and regulatory provisions applicable for the project shall be carried out in this task. The objective of the review is to bring out the legal and policy issues to be addressed in the project at various stages of project development such as design, execution and operation. Also the contractor should review the environmental laws such as EP Act, Water Act, Air Act, as well as the applicable operational policies / directives of The World Bank. Besides, the contractor shall also provide a complete list of regulatory formalities required for the project and various clearances required from different regulatory agencies.

Task 4: Preparation of Environmental Profile

An environmental profile of the project influence area shall be prepared, based on appropriate primary & secondary surveys and field investigations. The objective of this profile is to establish existing environmental conditions of the project area, in terms of air, water (surface & ground), noise, soil and other environmental parameters, which should form the basis for prediction of impacts due to proposed project activities. As part of this, the environmentally sensitive land uses (protected natural areas, areas of ecological value, sensitive receptors like schools, hospitals etc.) would also be identified and plotted on a map to scale.

The extent and duration of surveys shall be judiciously decided by the contractor as per requirements of the environmental regulations applicable in India and guidelines of international funding agencies. The profile prepared shall be adequate enough to predict impacts of the project and shall cater to the requirements of obtaining necessary environmental clearances from the authorities.

The profile shall essentially include all physical, ecological and socio-economic components of the project environment and bring out the salient and sensitive features of the same. Important aspects such as reserve forests, national parks, major water bodies, structures of archaeological / historic importance, and other environmental resources (if any) shall be identified and salient features of the same shall be presented.

Task 5: Determination of Potential Impacts

Based on the environmental profile of the project area prepared above and the proposed project activities discussed under task 1, the contractor shall carry out environmental screening to determine the nature of impacts and level of Environmental Assessment to be carried out (refer Section 3 for the details to be carried out under Environmental Screening).

In case of low or insignificant level of environmental impacts, where an EMP will suffice, the contractor shall review the recent versions of generic EMPs available with OPCB or the State Department and carry out necessary changes to suit the project requirements.

As part of screening, if medium to high impacts, requiring a detailed EA and standalone EMP is required, the contractor shall carry out detailed impact analysis. The contractor shall predict environmental impacts of the project components, activities and sub-activities on various environmental attributes (bio, geo and physical) through appropriate analytical tools and techniques such as modelling techniques, over lays, etc. Significant or insignificant, permanent or temporary, reversible or irreversible, negative or positive impacts shall be categorized separately and presented for each phase of project development.

All identified impacts shall be summarised in an easily understandable format and the magnitude and significance of each impact shall be explained in detail.

An analysis of various project alternatives, including the 'Project' and 'No Project' scenario shall be analyzed and impacts shall be analyzed for each scenario. Based on the above analysis the best alternative that causes minimum or no impact shall be recommended for implementation.

Task 6: Social Assessment

Magnitude of social impacts due to loss of land, structures, income, livelihood etc. shall be assessed. Significant findings of census and social economic survey of PAPs along with a brief account of proposed mitigation measures using the ESF guidelines, budget shall be brought out in the report. Institutional arrangements with resettlement implementation plan shall be provided where required.

Task 7: Stakeholder Consultations

The contractor shall carry out consultations with Experts, NGOs, forest department officials (if applicable) and other selected Government Agencies and other stakeholders to (a) collect baseline information, (b) obtain a better understanding of the potential impacts and (c) appreciate the perspectives / concerns of the stakeholders, and (d) secure their active involvement during subsequent stages of the project as appropriate.

Consultations shall be preceded by a systematic stakeholder analysis, which would (a) identify the individual or stakeholder groups relevant to the project and to environmental issues, (b) include expert opinion and inputs, (c) determine the nature and scope of consultation with each type of stakeholders, and (d) determine the tools to be used in contacting and consulting each type of stakeholders. A systematic consultation plan with attendant schedules will be prepared for subsequent stages of project preparation as well as implementation and operation, as required. Where community consensus is required in respect of proposed mitigation measures for impacts on community assets including water bodies, places of worships etc., specific plan for modification/relocation etc. have to be disclosed and consensus obtained.

Task 8: Environmental Management Plan

The contractor using outputs of the above tasks shall prepare an implementable Environmental Management Plan (EMP) for the project. Preparation of Environmental Management Plan is detailed under Section 4 below.

3. Environmental Management Plan

The EMP should suggest ways / options for mitigating negative impacts of the project, the preventive measures necessary. Where required, EMP shall include community consensus for the mitigation measures proposed. The EMP shall identify the means / agency responsible for implementation of the same and recommend suitable monitoring mechanism for the EMP. The EMP shall be implemented fully by the Contractor.

The above referred activity shall be applicable for Generic EMPs as well as specific EMPs developed as an outcome of detailed EIAs.

The contractor shall prepare a detailed EMP covering the measures to mitigate and/or minimize the negative impacts, including the implementation arrangement and a monitoring plan for the same with site specific requirements. EMP shall cover the following details:

Mitigatory measures: For each of the significant negative impact the contractor should recommend measures to eliminate or mitigate the impact. In case any impact is non-mitigable, the cost of damage shall be estimated. The cost (capital and recurring) of all the mitigation measures and the responsible parties for implementation should be clearly identified. The mitigatory measures should necessarily contain conceptual designs wherever necessary. The contractor should also specify neighbourhood committees to supervise effective implementation of the proposed mitigatory measures.

Landscape plan: Wherever necessary (especially STP sites), the Landscaping plan should be prepared considering the project area as a whole and shall meet project specific requirements. Considering the nature of the project area, the EA should provide a conceptual landscape plan for all the project components while considering the special environmental and social needs.

Monitoring Plan: The contractor should specify the types of monitoring needed for potential environmental impacts during construction and operation. As in the case of the mitigation plan, requirements should be specific as to what is to be monitored, how and by whom along with reporting formats and recommendations if any Cost estimates are necessary and where monitoring reports are to be prepared, the recipient responsible for review and any corrective action should be identified. The monitoring plan should be supplemented with a detailed schedule of implementation of EMP measures.

Institutional Arrangement to Manage Environment Impacts Effectively: The contractor shall identify institutional/organizational needs to implement the recommendations of the project EA and to propose steps to strengthen or expand, if required. This may extend to new agency functions, inter-sectoral arrangements, management procedures and training, staffing, operation and maintenance, training and budgeting.

4.0 Public Disclosure

The contractor is to provide support and assistance to the Client in meeting the disclosure requirements, which at the minimum shall meet the World Bank's policy on public disclosure. The contractor will prepare a plan for in-country disclosure, specifying the timing and locations; translate the key documents, such as the EA Summary in local language; draft the newspaper announcements for disclosure; and help the client to place all the EA reports in the client's website. The contractor shall prepare a non-technical EA Summary Report for public disclosure.

5.0 Review Committee

The review committee comprising of representatives from OWSSB / OPCB will review and clear the EIA report. Payment will be made after approval of the EIA by the review committee.

6.0 Pre-Construction Phase Impacts

| Sl. | Potential Negative Impacts | Mitigation Measures | Time frame | Responsible agencies |
|-------------------------------|----------------------------|--|---------------------------------------|--|
| PRE-CONSTRUCTION STAGE | | | | |
| 1 | Clearances | All clearance required for Environmental aspects during construction shall be ensured and made available before start of work. | Before construction | ULB / OWSSB / Concerned Departments & agency/ Contractor |
| 2 | Tree Cutting | <p>i) Try to save the trees by adjusting the plant layout or the alignment of sewage intake structures, sewer mains, pumping stations, etc.</p> <p>ii) Provide adequate protection to the trees to be retained with tree guards (e.g. Masonry tree guards, Low level RCC tree guards, Circular Iron Tree Guard with Bars) as required.</p> <p>ii) Identify the number of trees that will be affected with girth size & species type along the sewer mains, pumping / lifting station sites and sewerage treatment plant site. The details to be indicated on map to scale and/or a strip map as may be appropriate. Prepare tree cutting schedule to facilitate clearance requirements</p> <p>iii) Trees identified for cutting shall be removed from the construction sites before commencement of construction with prior permission from the concerned department.</p> <p>iv) Undertake tree plantation (not less than three rows inside and along the boundary of STP, and compensatory plantation as per the tree cutting clearances).</p> <p>v) Compensatory plantation by way of Re-plantation of at least twice the number of trees cut should be carried out in the project area.</p> | Pre-construction & construction phase | Contractor / OWSSB |

| | | | | |
|---|--|---|--|--------------------------------|
| 3 | Utility Relocation | <p>i) Identify the common utilities to be affected such as: telephone cables, electric cables, electric poles, water pipelines, public water taps, etc.</p> <p>ii) Affected utilities shall be relocated with prior approval of the concerned agencies before construction starts.</p> <p>iii) provide advance notice (not less than 10 working days) to affected parties. The advance notice shall be in the form of written notice and a grievance redressal cell shall be established for timely addressing of grievances</p> | Pre-construction & construction phase | OWSSB / Concerned departments |
| 4 | Baseline parameters | Adequate measures shall be taken and checked to control the Baseline parameters of Air, Water and Noise pollution. Base line parameters shall be recorded and ensured conformance till the completion of the project. The monitoring requirements, at minimum shall comply with consent conditions by the pollution control board | Pre-construction, construction and post-construction phase | Prospective contractor / OWSSB |
| 5 | Planning of temporary Traffic arrangements | <p>i) Temporary diversion will be provided with the approval of the engineer. Detailed traffic control plans will be prepared and submitted to the engineers for approval, at least two weeks prior to commencement of works.</p> <p>ii) The traffic control plans shall contain details of temporary diversion, details of arrangements for construction under traffic, details of traffic arrangement after cessation of work each day, SIGNAGES, safety measures for transport of hazardous materials and arrangement of flagmen.</p> <p>iii) Any accidents and/or risk of inconveniences caused to the community shall be borne by the contractor</p> | Pre-construction & construction phase | Prospective contractor / OWSSB |
| 6 | Disposal of treated waste water. | <p>i) The construction activities at STP shall be initiated after consent to establish certificate is secured from OPCB</p> <p>ii) STP operations shall take place only after Consent to Operate certificate is accorded by the OPCB and the treated water quality shall comply with the consent conditions stipulated by OPCB or at minimum shall meet the discharge standards depending on the type of receiving waterbody (stream / nallah / open land / irrigation purposes, etc.)</p> <p>iii) performance standards shall always be maintained, ensuring efficient working condition of treatment plant.</p> | Pre-construction & construction phase | ULB/OWSSB |

| | | | | |
|---|----------------------------------|--|---------------------------------------|--------------------------------------|
| 7 | Storage of materials | The contractor shall identify the site for temporary use of land for construction sites / storage of construction materials, etc. These sites shall be operated only after prior approval of the engineer. | Pre-construction & construction phase | Prospective contractor / OWSSB |
| 8 | Construction of labour camps | <p>Contractor shall follow all relevant provisions of the Factories Act, 1948 and the Building and the other Construction Workers (Regulation of Employment and Conditions of Service) Act, 1996 for construction and maintenance of labour camp. The location, layout and basic facility provision of each labour camp will be submitted to Engineer prior to their construction.</p> <p>The construction will commence only upon the written approval of the Engineer.</p> <p>The contractor shall maintain necessary living accommodation and ancillary facilities in functional and hygienic manner and as approved by the Engineer.</p> <p>All temporary accommodation must be constructed and maintained in such a fashion that uncontaminated water is available for drinking, cooking and washing. The sewage system for the camp must be planned. Adequate health care is to be provided for the work force. The layout of the construction camp and details of the facilities provided should be prepared and shall be approved by the engineer. The construction camp shall not be located within 1000m from the nearest water stream, residential areas and/or any sensitive land uses like schools, hospitals, etc.</p> | During the construction | Prospective contractor |
| 3. CONSTRUCTION STAGE | | | | |
| Construction of Septage Treatment Plant | | | | |
| 3.1 | Compensatory plantation of trees | Compensatory plantation of at least twice the number of trees felled should be done in line with competent authority guidelines. | Pre-construction and Construction | Prospective contractor / ULB / OWSSB |

| | | | | |
|-----|--|---|-----------------------------|--------------------------------|
| 3.2 | Protection of top soil & Environmental enhancing | The top soil to be protected and compacted after completion of work. Top soil from the STP area should be stored in stock piles and that can be used for gardening purposes at WTP site which will be an environmental enhancing measure. | During construction | Prospective contractor / OWSSB |
| 3.3 | Disposal of construction debris and excavated materials. | A suitable site should be identified for safe disposal, in relatively low lying areas, away from the water bodies, residential and agricultural fields etc., and got approved by the Engineer. Care should be taken that dumped material does not affect natural drainage system. | During construction | Prospective contractor / OWSSB |
| 3.4 | Pollution from Fuel and Lubricants | <p>i) The contractor shall ensure that all construction vehicle parking location, fuel/lubricants storage sites, vehicle, machinery and equipment maintenance and refueling sites will be located at least 500 m from rivers and irrigation canal/ponds.</p> <p>ii) All location and lay-out plans of such sites shall be submitted by the Contractor prior to their establishment and will be approved by the Engineer.</p> <p>iii) Contractor shall ensure that all vehicle/machinery and equipment operation, maintenance and refueling will be carried out in such a fashion that spillage of fuels and lubricants does not contaminate the ground.</p> <p>iv) Contractor will arrange for collection, storing and disposal of oily wastes to the pre- identified disposal sites (list to be submitted to Engineer) and approved by the Engineer. All spills and collected petroleum products will be disposed off in accordance with MoEF and state PCB guidelines.</p> <p>v) Engineer will certify that all arrangements comply with the guidelines of PCB / MoEF or any other relevant laws.</p> | Construction and operation. | Prospective contractor / OWSSB |

| | | | | |
|-----|--|---|-----------------------------------|--------------------------------|
| 3.5 | Contamination of ground water quality | <p>i) Groundwater quality may get contaminated due to leaching of waste water. So, the treated water quality shall comply with the standards laid down by the PCB for disposal onto land, water body or for irrigation use.</p> <p>ii) Regular monitoring is required for the treated sewage quality and also the ground water quality in the nearby areas and ensures compliance with PCB standards.</p> | During construction and operation | Prospective contractor / OWSSB |
| 3.6 | Water Pollution from Construction Wastes | <p>The Contractor shall take all precautionary measures to prevent the wastewater generated during construction from entering into streams, water bodies or the irrigation system.</p> <p>All waste arising from the project is to be disposed off in the manner that is acceptable by the Engineer.</p> | During Construction | Prospective contractor / OWSSB |
| 3.7 | Impact of surrounding areas | To avoid the problems of foul smell polluted air, insects, noise pollution and other problems buffer zones to be provided in the form of green belt around the STP site, this has to be strictly ensured. | During Construction | Perspective contractor / OWSSB |
| 3.8 | Informatory Signs and Hoardings | The contractor shall provide, erect and maintain informatory / safety signs, hoardings written in English and local language, wherever required or as suggested by the Engineer. | During construction | Prospective contractor / OWSSB |
| 3.9 | Risk from Electrical Equipment(s) | <p>The Contractor shall take all required precautions to prevent danger from electrical equipment and ensure that -</p> <p>i) No material shall be stacked or placed as to cause danger or inconvenience to any person or the public.</p> <p>ii) All necessary fencing and lights will be provided to protect the public in construction zones. All machines to be used in the construction will conform to the relevant Indian Standards (IS) codes, will be free from patent defect, will be kept in good working order, will be regularly inspected and properly maintained as per IS provision and to the satisfaction of the Engineer.</p> | During construction | Prospective contractor |

| | | | | |
|------|----------------------------------|---|--|------------------------------------|
| 3.10 | Disposal of treated waste water. | <p>i) The treated water quality shall comply with the standards of OPCB before let out into the stream / nallah / open land /irrigation purposes, and necessary permission to be obtained from the concerned department.</p> <p>ii) Ensure efficient working condition of treatment plant.</p> <p>iii) Prevent the pollution of stream water and other water bodies receiving STP discharge.</p> | Pre-construction / construction and operation stage. | OWSSB / ULB Prospective contractor |
| 3.11 | Disposal of sludge | A suitable site should be identified for the safe disposal of sludge generated at the STP site and got approved by the Engineer. Prepare a sludge disposal plan and adheres to the same. | Pre-construction, construction and operation. | Prospective contractor ULB / OWSSB |
| 3.12 | Labour camp & facilities | Setting up of labour camps needs to be done as per the procedures. Adequate potable water facilities, sanitation and drainage etc., in conformity with the Indian labour laws shall be ensured. | During Pre-construction and construction | Perspective contractor / OWSSB |
| | | <p>The contractor shall also guarantee the following:</p> <p>i) The location, layout and basic facility provision of each labour camp will be submitted to Engineer prior to their construction.</p> <p>ii) The construction will commence only upon the written approval of the Engineer.</p> <p>iii) The Contractor shall construct and maintain all labour accommodation in such a fashion that uncontaminated water is available for drinking, cooking and washing.</p> <p>iv) Supply of sufficient quantity of potable water (as per IS) in every workplace/labor camp site at suitable and easily accessible places and regular maintenance of such facilities.</p> <p>v) The sewage system for the camp are designed, built and operated in such a fashion that no health hazards occur and no pollution to the air, ground water or adjacent water courses take place. Ensure adequate water supply is to be provided in all toilets and urinals.</p> | | |

| | | | | |
|------|----------------|---|---------------------|------------------------|
| 3.13 | Safety Aspects | <p>i) Adequate precautions shall be taken to prevent the accidents and from the machineries. All machines used shall confirm to the relevant Indian Standard Code and shall be regularly inspected by the PIA.</p> <p>ii) Where loose soil is met with, shoring and strutting shall be provided to avoid collapse of soil.</p> <p>iii) Protective footwear and protective goggles to all workers employed on mixing of materials like cement, concrete etc.</p> <p>iii) Welder's protective eye-shields shall be provided to workers who are engaged in welding works.</p> <p>iv) Earplugs shall be provided to workers exposed to loud noise, and workers working in crushing, compaction, or concrete mixing operation.</p> <p>v) The contractor shall supply all necessary safety appliances such as safety goggles, helmets, safety belts, ear plugs, mask etc. to workers and staffs.</p> <p>The contractor will comply with all the precautions as required for ensuring the safety of the workmen as per the International Labor Organization (ILO) Convention No. 62 as far as those are applicable to this contract.</p> <p>The contractor will make sure that during the construction work all relevant provisions of the Factories Act, 1948 and the Building and other Construction Workers (regulation of Employment and Conditions of Services) Act, 1996 are adhered to.</p> <p>The contractor will not employ any person below the age of 14 years for any work and no woman will be employed on the work of painting with products containing lead in any form</p> | During construction | Prospective contractor |
|------|----------------|---|---------------------|------------------------|

| | | | | |
|------|--|--|---------------------|------------------------|
| 3.14 | First Aid | <p>The contractor shall arrange for:</p> <p>i) A readily available first aid unit including an adequate supply of sterilized dressing materials and appliances as per the Factories Rules in every work zone</p> <p>ii) Availability of suitable transport at all times to take injured or sick person(s) to the nearest hospital</p> | During construction | Prospective contractor |
| 4.0 | Environmental enhancement and special issues | | Implementing Agency | Location |
| 4.1 | Flora and Chance found Fauna | <p>The contractor will take reasonable Precaution to prevent his workmen or any other persons from removing and damaging any flora (plant / vegetation) and fauna (animal) including fishing in any water body and hunting of any animal.</p> <p>If any wild animal is found near the construction site at any point of time, the contractor will immediately upon discovery thereof acquaint the Engineer and carry out the Engineer's instructions for dealing with the same.</p> <p>The Engineer will report to the nearby forest office (range office or divisional office) and will take appropriate steps/ measures, if required in consultation with the forest officials.</p> | Project area | Prospective contractor |
| | Chance Found Archaeological Property | <p>All fossils, coins, articles of value of antiquity, structures and other remains or things of geological or archaeological interest discovered on the site shall be the property of the Government and shall be dealt with as per provisions of the relevant legislation.</p> <p>The contractor will take reasonable precautions to prevent his workmen or any other persons from removing and damaging any such article or thing. He will, immediately upon discovery thereof and before removal acquaint the Engineer of such discovery and carry out the SC's instructions for dealing with the same, waiting which all work shall be stopped.</p> <p>The Engineer will seek direction from the Archaeological Survey of India (ASI) before instructing the Contractor to recommence the work in the site.</p> | Project area | Prospective contractor |

| | | | | |
|-----|---|--|--------------------|------------------------|
| 4.3 | Monitoring of environment parameters | The contractor shall undertake seasonal monitoring of air, water, noise and soil quality through an approved monitoring agency. The parameter to be monitored, frequency and duration of monitoring plan shall be prepared. | Project area | Prospective contractor |
| 4.4 | Sensitive Areas | The sensitive areas like Schools, hospitals to be provided with suitable noise barriers and safety measures, prior to the start of work in order to minimize the dust and noise impacts due to vehicle movement during construction and their effectiveness to be checked during operation phase. | Project area | Prospective contractor |
| 4.5 | Clearing of construction of camps and restoration | Contractor to prepare site restoration plans for approval by the engineer. The plan is to be implemented by the contractor prior to demobilization. On completion of the works, all temporary structures will be cleared away, all rubbish cleared, excreta or other disposal pits or trenches filled in and effectively sealed off and the site left clean and tidy, at the contractor's expenses, to the entire satisfaction of the engineer. | Corridor of Impact | Prospective contractor |
| 4.6 | Tree Protection, Tree Planting, | Giving due protection to the trees that fall in the shoulders /corridor of impact shall be the prime focus during Construction / post construction Masonry tree guards, Low level RCC tree guards, Circular Iron Tree Guard with Bars, use of plate compactors near trees may also be considered where necessary Re-plantation of at least twice the number of trees cut should be carried out along the project road. Since the major portion of the project road may pass through open lands, planting of trees along the entire stretch of the road is recommended as an enhancement measure. Growth and survival of trees planted shall be ensured and monitoring done at least for a period of 3 years. Survival status shall be reported on monthly basis to Engineer-in-charge. | Corridor of Impact | Prospective contractor |

7. Environmental Monitoring Plan

To monitor the extent of environmental impact of the proposed project, the contractor has to periodically monitor the ambient environmental quality along the proposed project area. The monitoring requirement for the different environmental components is presented in table below;

| Air Quality Monitoring | |
|--------------------------|--|
| Project stage | Pre-Construction, Construction & operation period (as agreed) |
| Parameter | SPM, RPM, SO ₂ , NO _x , CO and Pb |
| Sampling Method | Use method specified by CPCB for analysis |
| Standards | Air (Prevention and Control of Pollution) Rules, CPCB, 1994 |
| Frequency | Once before start of work & once every season of the year during construction period & up to 18 months (operation Period) |
| Duration | Continuous 24 hours / or for 1 full working day |
| Location | Sensitive locations along the pipe laying work, pumping / lifting station locations, STP site. |
| Measures | Wherever air pollution parameters increase above specified standards, additional measures as decided by the engineer shall be adopted |
| Implementation | Contractor through approved monitoring agencies |
| Supervision | Implementing agency |
| Water quality Monitoring | |
| Project stage | Pre-Construction & Construction |
| Parameter | pH, BOD, COD, DO, TDS, Pb, Oil & Grease and Detergents for Surface water. Water pH, TDS, Total hardness, Sulfate, Fluorides, Chloride, Fe, Pb for groundwater. |
| Sampling Method | Grab sample collected from source and analysis as per Standard Methods for Examination of water and Waste water |
| Standards | Indian standards for Inland Surface Water (IS; 2296, 1982) and for Drinking water (IS; 10500,1991) |
| Frequency | Twice a year (pre monsoon and post monsoon seasons) during the construction period |
| Duration | Grab sampling |
| Location | Locations to represent residential, agricultural, surface water quality and vicinity of the construction site. |
| Measures | At locations of increased in water pollution, all inflow channels shall be checked for pollution loads and channel delivering higher pollution loads and channel delivering higher pollution load shall be terminated from disposal into the water source and other methods of disposal shall be adopted |
| Implementation | Contractor through approved monitoring agencies |
| Supervision | Implementing agency |
| Noise Level Monitoring | |
| Project stage | Pre-construction, Construction & operation period (as agreed) |
| Parameter | Noise level on dB (A) scale noise levels on dB (A) scale |
| Special guidance | Free field at 1 m from the equipment whose noise level are being determined. Equivalent noise levels using an integrated noise level meter kept at a distance of 15m from edge of pavement |
| Standards | MoEF Noise Rules, 2000 |
| Frequency | Once every seasons (except monsoon) for each year of construction |
| Duration | Reading to be taken at 15 seconds interval for 15 minutes every hour and then averaged |
| Location | Wherever the contractor decides to locate the equipment yard. At sensitive location such as school, hospitals etc. |

| | |
|--------------------------------|---|
| Measures | In case of noise levels causing disturbance to the sensitive receptors, management measures as suggested in the EMP shall be carried out. |
| Implementation | Contractor through approved monitoring agencies |
| Supervision | Implementing agency |
| Soil Quality Monitoring | |
| Project stage | Pre-Construction & Construction |
| Parameter | Monitoring of Pb, SAR and Oil & Grease |
| Sampling Method | Sample of soil collected to be acidified and analyzed using absorption spectrophotometer |
| Standards | Threshold for each contaminated set by IRIS database of USEPA until national standards are promulgated |
| Frequency | During the pre-monsoon post monsoon seasons each year for the entire construction period |
| Duration | Grab sampling |
| Location | At productive agriculture lands abutting traffic detours, pumping / |
| Measures | At location of increased in pollution levels, source shall be identified and shall be diverted from future disposal |
| Implementation | Contractor through approved monitoring agencies |
| Supervision | Implementing agency |

Apart from the above mentioned monitoring requirements, any major accidents /spillage during bulk transport of hazardous materials. Depending on the type of spillages / accidents the parameters to be monitored will be decided by the engineer and should be carried out by the contractor through approved monitoring agencies and supervised by the Implementing agency at their own cost.

8. FORMATS FOR REPORTING:

Formats for reporting / monitoring the progress / parameters achieved will be finalized in consultation with the successful bidder.

9. Environmental Compliance Report

The contractor shall submit a monthly progress report as per the reporting format approved by the engineer, on the status of the implementation of the EMP, and get it duly approved by the engineer for its compliance and for proceeding with the work. The Engineer and the Environmental and Social Safeguard (ESS) Manager, who will have access and authority to monitor the status based on the same and for which necessary facilities shall be made by the contractor.

10. Environmental Protection Work

10.1 The Contractor shall have to take following measures during construction and commissioning of works for protection of environment as under to avoid environmental impacts on air, water and land.

10.2 Site Clearance

The site clearance shall be done with minimum damage to existing structures flora and fauna, electricity and telephone lines and other infrastructure service.

10.3 Earth Work and Excavation

The Contractor shall inform the local authorities / government if any fossils, coins artifacts of value or antiquity, structures and other remains of geological or archaeological interests and excavation shall be stopped until identification of cultural relics by the authorized institution is completed.

The Contractor shall dispose off surplus / waste material at identified sites approved by the Engineer. The Contractor shall ensure that there is minimum hindrance to normal activities and business. The Contractor shall avoid damage to permanent structures and shall avoid loss of standing crops along the road.

10.4 Replantation

The Contractor shall carry out Replantation on areas / on the periphery of construction sites to minimize visual impact and soil erosion. The Contractor shall pay special attention to the type of trees to be replanted to prevent fouling of water through falling leaves and bird droppings. A list showing the type of trees to be replanted will be got approved before replanting any trees.

10.5 Soil Erosion and Water Quality

The Contractor shall ensure that earth and stone do not silt up existing irrigation /drainage systems.

The Contractor shall take suitable measures to prevent direct discharge of polluted waters form construction activity into lakes/rivers/irrigation channels.

The Contractor shall minimize exposure of soil types susceptible to wind and water erosion.

The Contractor shall control run-off and erosion through proper drainage channels and structures.

10.6 Soil Compaction

The Contractor shall restrict traffic movements and use low ground pressure machines. The Contractor shall preserve topsoil to be replaced after completion of construction activity.

The Contractor shall avoid wet soils.

10.7 Social Disruption

The Contractor shall minimize interruptions to utility services through proper planning and scheduling of activities.

The Contractor shall provide temporary roads and diversions as may be necessary for smooth flow of traffic.

The Contractor shall preferably use local labour / Skilled persons during construction.

10.8 Dust / Air Pollution

The Contractor shall provide effective dust control through sprinkling / washing of construction sites and access roads.

The Contractor shall cover / water stockpiles and storage areas to prevent dust pollution. The Contractor shall cover trucks transporting construction materials to minimize spills.

The Contractor shall have a preventive maintenance program for construction equipment and vehicles to meet emission standards.

10.9 Noise Pollution

The Contractor shall normally undertake construction work during daytime only (between 6.92.30 to 18.00 hrs) and when authorized to work beyond these hours adopt suitable noise control methods during such works.

The Contractor shall maintain machines and trucks to keep them with low noise.

The Contractor shall install sound barriers and plant tree as appropriate during construction.

10.10 Construction Camps

The Contractor shall take adequate measures such as provision of septic tank / pit latrines at construction site / camps.

The Contractor shall provide crèches to working women labour.

The Contractor shall provide drinking water conforming to IS: 10500

The Contractor shall provide garbage cans at suitable fixed place and have the garbage disposed off regularly.

10.11 Aesthetic Improvement

The Contractor shall through proper housekeeping enhance aesthetic appearance of construction sites.

The Contractor shall dispose-off construction wastes at approved disposal sites.

The Contractor shall repair pavements immediately following construction pipeline and appurtenant structures.

The Contractor shall remove after completion of construction, all temporary structures and restore the project and surrounding areas nearest possible to the pre-construction condition.

10.12 Conservation of Ecological Resources

The Contractor shall not use farmland and forest belts as materials borrow sites.

The Contractor shall not select arable land as material borrows site. In case excavation in arable land is unavoidable, topsoil layer (30 cms. depth) shall be saved and returned after construction work is completed so as to minimize impacts on ecosystem, agriculture and animal husbandry.

The Contractor shall educate construction workers to protect natural resources, wild plants and animals.

10.13 Risk of Accidents

The Contractor shall provide efficient lighting equipment and safety signs on temporary roads during construction and shall adopt and implement adequate traffic regulation.

The Contractor shall take effective safety and warning measures to reduce accidents. The Contractor shall provide suitable temporary crossings to facilitate normal life and business.

10.14 Responsibility for Accidents, Damages etc.

The care of the whole of the permanent work until their completion and the whole of the temporary work until their removal shall remain with the Contractor who shall be responsible for all accidents or damages from whatever cause arising and chargeable for anything that may be stolen, removed, destroyed or damaged to whomsoever belonging and also for making good all defects and damages to the said Works or to any property adjoining or any cause whatever, whether such damage or defects were occasioned by the negligence of the Contractor or not or may be or might have been discovered during the progress of the works or in consequence thereof, or shall appear to be known after the completion whereof or whether payment may wholly or partially have been made or the Works approved as supposed to have been properly done, and no certificate or approval of any works by any officers or members of the Employer shall effect

10.15 Noise Monitoring

a. Monitoring Frequency:

- a) During construction period: 12 times a year each time including day and night.
- b) During Commissioning period: 4 times ad hoc monitoring will be taken.
- c.) During construction period: Near construction sites, factory sites and sensitive areas.

XIII. TRIAL RUN OF SEPTAGE SCHEME

GENERAL

On completion of the construction, trial operation and commissioning of all the components of the project, the same shall be taken over by the employer and the same shall be handed over back to the Contractor, for Trial Operation for a period of 3 months at contractor cost.

The following measures are to be taken essentially by the contractor Necessary maintenance crew with supervisory staff shall be deployed as specified. The entire strength of maintenance crew with the supervisory personnel should be available from the first day of the Trial run period.

The staff to be deployed shall be adequately qualified for the performance of the job and trained in operation of electrical equipment, pumps, etc. and also capable of identifying and managing trouble shooting of faults and attend minor repairs.

The contractor should keep all spares required for replacements at the pumping stations, pumping main, Septage treatment plant, etc. as recommended by the respective manufactures readily available to ensure proper functioning of the Septage system.

All the equipment that go out of order during the course of the Trial run period shall be rectified/ replaced within a week's time or such longer time as approved by the employer, to ensure uninterrupted operation of me plant.

The contractor is responsible for the incidence of any theft, malpractice etc. within the project area during the Trial run period and the contractor shall keep the Employer indemnified.

On completion of Trial run period of 3 months, the contractor shall hand over to the employer in good working condition all the components of the project taken over by him as mentioned in para 1 above.

One set of as laid plans of all the components of the project - Architectural, mechanical, instrumentation, piping drawings, sections details charts etc., with modifications as carried out (with the approval of employer) shall be supplied. Operating and maintenance manuals supplied by manufacturer and Step by step procedures for all operation requirements and adjustments required shall be given.

The contractor shall carry out the works observing all safety precautions. The owner shall be indemnified for any accidents that may occur at the site.

The contractor shall follow all the rules and regulations of statutory authorities Government agencies etc. The owner shall be indemnified against any failure.

The contractor shall take necessary insurances for the property and labour etc., The owner shall be indemnified against any failure.

The contractor shall pay all the fines, penalties etc., imposed by various agencies for non-performance / non adherence to rules in connection with his work. The owner shall be indemnified.

1. ENERGY CONSUMPTION

The electrical energy consumed for the operation of the pump sets and other pumping station accessories shall be borne by the contractor direct to the CESU.

The Contractor shall ensure strict economy in electricity usage for lighting and as well as for pumping sewage by using high duty pumps only when the rate of flow to the pumping station cannot be handled satisfactorily by low duty pumps. All level controls shall be maintained in operating condition always.

Any diversion of electricity from the Septage project installations for unauthorized purpose will invite penal action as directed by the Engineer.

In the pumping stations where the HT supply has been availed, maximum demand in KVA is to be controlled. The operator should ensure that the maximum demand in KVA does not shoot up in any case than the contractual maximum demand, since any excess over the contractual maximum demand invites double the cost per KVA to be paid to CESU. The maximum demand shall be fixed with reasonable margin by the Employer. The contractor shall train persons in all aspects and post suitable persons. In case of any excess over the fixed KVA as in the electric consumption statement for the maximum point of full designed capacity appended the excess amount to be paid to CESU has to be borne by the contractor.

The power factor should be maintained at 0.95 and pump sets shall operate at the efficiency specified by the manufacturer. Any excess consumption of electricity for not adhering to be above, the contractor has to bear the cost. The low power factor compensation charges levied by the CESU has to be borne by the contractor. Diesel oil required for operation of pumping plants shall be paid for by the contractor.

2) SAFETY PRECAUTIONS

Traffic Control

- a. Place easily readable and clear warning signs well ahead of work area.
- b. Barricade the space around the manhole for placing equipment and deposition of silt removed.
- c. Place barricades or signs to channelize the traffic, if possible.
- d. Use a flagman at the two ends for controlling flow of traffic from each, direction and to avoid a traffic jam, if the road is narrow and only one lane of traffic is possible.

Safety Equipment

The various safety equipment that are normally required in sewer maintenance work are gas masks, oxygen breathing apparatus, portable lighting equipment, non-sparking tools, portable air blowers, safety belts, inhalators and diver's suit.

The use of the particular safety equipment is governed by the detection of various gases and oxygen deficiency.

A knowledge of the type of gases, in the atmosphere and of the working location becomes essential for the selection of the right type of safety equipment. Simple tests for detection of various gases and oxygen deficiency Should be furnished to the workmen.

a. Gas Masks

General purpose gas masks are used for respiratory protection from low and moderately high concentrations of all types of toxic gases and vapors present in the atmosphere, in which there is sufficient oxygen to support life.

Persons using gas masks should practice regularly with them in order to become proficient in putting them on quickly and breathing through them.

Gas masks cannot be used in Oxygen deficient atmosphere, in unventilated locations or areas where large concentrations of poisonous gases exist.

b. Breathing Apparatus

This is designed for respiratory protection from atmosphere that contains very high concentrations of toxic gases and vapors or that are deficient in oxygen.

c. Air Hose Respirator

This is used where a source of fresh air is available within a distance of 50 m from the working location. It is essential that the supply of air is obtained from an uncontaminated source. Purified air is used where a source of fresh air is not available within 50 m to permit the use of an air hose respirator or in situations where an air hose would encumber the worker.

d. Portable Lighting Equipment

The equipment normally used are portable electric hand lamps of either 24 V or 110 V grade or permissible types, electrical cap lamps and explosion proof flash lights.

e. No sparking Lighting Equipment

These are made of an alloy (containing at least 80 percent of copper) that will not spark when struck against other objects and metals and yet retains the necessary strength and resistance to wear.

f. Portable Air Blowers

Forced ventilation of manholes, pits and tanks can be provided by portable air blowers. Special precautions should be taken to ensure that the blowers do not serve as a source of ignition for inflammable gases.

g. Safety Belt

This consists of a body belt with a bucket and a shoulder harness. The life line is of high grade spliced manila rope, nylon rope or a steel cable anchored with rings on each side of the belt and provided with safety straps for anchoring or securing to a stable support. The life line should be about 15 m in length and the overall assembly should be capable of withstanding a tensile load of 2000 kg. The safety belt and the life line should be tested by lifting the wearer clear of ground before each day's use.

h. Inhalators

Approved inhalators employing a mixture of oxygen and carbon dioxide are used for resuscitating victims of gas collapse, drowning or electric shock.

i. Diver's Suit

A good quality diver suit should be provided to the diver whose services are very necessary while plugging the sewer line or removal of some hard blockage due to stone etc. at the mouth of the pipe in the manholes. Depending upon the site condition, 'suit should have provision to conned an air line with compressor or oxygen cylinder.

Precautions against Electrical Shocks

- a. Only qualified and specially trained personnel should be allowed to operate and maintain electrical equipment.
- b. All electrical controls should be kept dry and in good condition.
- c. No metal ladders or metal tapes should be used around electrical equipment.
- d. Insulated rubber mats should be provided before all electrical control panels and they should be kept dry.
- e. Always test wires for current before working on any electrical item. Use tools with insulated handles and rubber gloves.
- f. All precautions to be taken as per statutory regulations are to be adhered to.

III. Septage Treatment Plant

- a. Where chemicals are used, the required precautions as prescribed during storage and handling of chemicals are to be taken.
- b. Safety measure like using of safety helmets, safety belts, gum boots safety slices, goggles, gloves, etc. are to be ensured depending on the operations performed.
- c. All safety precautions connected with work on electrical and mechanical installations to be followed.

3) RECORDS TO BE MAINTAINED BY CONTRACTOR

The following record are to be maintained by the Contractor during trial run. The format for the records are to be approved by the Engineer/employer.

1. Pumping Main

- Details of Installation
- Record of Inspection - leaks noticed, bursts and action taken

4) INSURANCE

The contractor shall without limiting his or the employer obligation and responsibilities insure the works together with materials and plant for incorporation therein to the full replacement cost (term cost in this context shall include profit)

The contractor's Equipment and other things brought on to the site by the contractor for a sum sufficient to provide for their replacement at the site.

The firm/contractor shall provide risk insurance at their/his cost against loss or damages to the construction and to their workmen to cover from the start date to the end of the Defects liability period, for the following events.

- Personal injury or death
- Loss of or damage to the works, plant, material
- Loss of or damage to Equipment
- Loss of or damage of property (except the works, plant, materials, and equipment) in connection with the contract.

policies and certificates for insurance shall be delivered by the contractor to the Engineer for the Engineer's approval before the Start Date. All such insurance shall provide for compensation to be payable in the types and proportions of currencies required to rectify the loss or damage incurred. The contractor will not be eligible for any payment on this account.

If the contractor does not provide any of the policies and certificates required, the Employer shall effect the insurance which the contractor should have provided and recover the premiums the Employer has paid from payments otherwise due to the contractor or, if no payment is due, the payments of premiums shall be a debt due.

Alterations to the terms of an insurance shall not be made without the approval of the Engineer.

XIV. Reference to Specifications / Code of Practice

| Description | BIS No. |
|--|-------------------------------|
| Ordinary Portland Cement (33 Grade) | 269 – 1976 |
| 43 Grade Ordinary Portland Cement | 8112 - 1989 |
| Pozzolona Portland Cement | 1489 - 1991 |
| Hydrophobic Portland Cement | 8043 - 1978 |
| Rapid Hardening Portland Cement | 8041 - 1990` |
| Low Heat Portland Cement | 12600 - 1989 |
| Sulfate resisting Portland cement | 12330 – 2001 |
| Standard sand for testing of cement | 650 – 1966 |
| Methods of Test for Pozzolanic Materials | 1727 - 1967 |
| Methods of sampling and test for water & waste water (Physical & Chemical) | 3025 - 1984 (Part I to 37) |
| Methods of Sampling hydraulic Cement | 3535 - 1986 |
| Methods of Physical tests for hydraulic cement | 4031 – 1988 (1 to 14) |
| Methods of chemical analysis of hydraulic cement | 4032 - 1985 |
| Aggregates coarse & Fine from Natural resources for concrete | 383 – 1970 4082/1977 |
| Sand for Masonry Mortar | 2116 - 1965 1542 / 1977 |
| Methods of tests for aggregates for concrete | 2386 - 1963 (Part 1 to 8) |
| Part I - Particle size and shape | 2386 - 1963 (Part-I) |
| Part - II - Estimation of deleterious Materials & Organic impurities | 2386 - 1963 (Part - II) |
| Part III – Soundness | 2386 - 1963 (Part - III) |
| Methods of sampling of aggregates for concrete | 2340 - 1986 |
| Specifications for test sieves Part I - Wire cloth test Sieves | 460 – 1978 (part - I) |
| Common Burnt clay building bricks | 1077 - 1976 |
| Mild Steel and Medium tensile steel bars and hard Drawn steel wire, concrete reinforcement, Part I Mild Steel & Medium Tensile Steel Bars Part II Hard drawn steel wire | 432 – 1982 |
| High Strength deformed steel bars and wires for Concrete reinforcement | 1786 - 1985 |

| | |
|--|---|
| High Tensile Steel for PSC Pipes | 1784 - 1986 (Part I) |
| Bending and flexing of bars for concrete reinforcement | 2502 - 1969 |
| Recommendation for detailing of reinforcement in reinforced concrete works | 5525 - 1969 |
| Methods for tensile testing steel wire | 1521 - 1972 |
| Methods of test for determining modulus of elasticity | 2854 - 1964 |
| Glossary of terms relating to cement concrete | 6461 - 1972 (Part 1 to 12) |
| Methods of test for strength of concrete | 516 - 1959 |
| Methods of sampling and analysis of concrete | 1990 - 1959 |
| Methods of testing bond in reinforced concrete pull out test | 2770 - 1967 |
| Methods of test for permeability of cement Mortar and concrete | 3085 - 1965 |
| Methods of test for splitting tensile strength of concrete cylinders | 5816 - 1970 |
| Methods of tests for determining setting time of concrete by penetration resistance | 8142 - 1976 |
| Code of practice for construction of Pile foundations (concrete piles) Driven cast-in-situ concrete piles Bored cast -in-situ piles Driven pre-cast concrete piles Bored pre-cast concrete piles | 2911 (Part I) Sec 1 - 1979 Sec 2 - 1979 Sec 3 - 1979 Sec 4 - 1984 |
| Code of practice for construction of raft foundation | 2950 - 1981 |
| Design Aids for reinforced concrete | SP 16 - 1980 |
| Explanatory Hand Book on codes for earthwork Engineering | SP 22 - 1982 |
| Explanatory Hand Book on IS Code 456 - 1976 | SP 24- 1983 |
| Hand Book on causes and prevention of cracks in buildings | SP 25 - 1984 |
| Hand book on concrete reinforcement and detailing | SP 34 - 1987 |
| Brick Masonry | 2212 - 1962 |
| Construction of Stone Masonry | 1957 - 1967 |
| Asbestos cement pressure pipes | 1592 - 1989 |
| Concrete pipes with and without reinforcement | 458 - 1988 |
| P.S.C. pipes (including fittings) | 784 - 1978 |
| Methods of tests for concrete pipes | 458 - 1988 3597 - 1985 |
| Materials for M.S. Specials | 226 - 1976 & 2062 - 1980 |
| Specification for M.S. Specials for P.S.C. Pipes | |
| Specification for Steel cylinders reinforced concrete pipes | 1916 - 1989 |
| Methods of tests for concrete pipes | 3597 - 1985 |
| Special for steel cylinders reinforced concrete pipes | 3597 - 1985 |
| Cast iron specials for asbestos cement pressure Pipes for water, gas & Sewage | 5531 - 1988 |
| Methods of test for asbestos cement products | 5913 - 1989 |
| Dimensional requirements of rubber sealing ring for | 10292 - 1988 |
| CID joints in asbestos cement pipe | |
| Centrifugally Cast (Spun) Iron pressure pipes for Water, gas and sewage including fittings | 1536 - 2001 |
| Specification for Centrifugally Cast (Spun) D.I. Pipes for Water, Gas and Sewage | 8329 - 1990 |

| | |
|---|---|
| D.I. fittings for pipes for water gas & Sewage | 9523 – 2000 |
| Dimensional requirements of rubber gaskets for mechanical joints and push on joints for the use with C.I., D.I. Pipes | 12820 – 1986 |
| C.I. Specials for Mechanical and push on flexible joints for pressure pipe lines for water, gas & sewage | 13382 – 1992 |
| Horizontally cast iron double flanged pipes for water, Gas and Sewage | 7181 – 1986 |
| Cast iron fittings for pressure pipes for water, gas and sewage | 1538 – 1976 (Part 1 to 24) |
| Cast iron detachable joints for use with asbestos cement pressure pipes | 8794 – 1988 |
| Rubber rings for jointing C.I. pipes, RCC Pipes & AC Pipes | 5382 – 1969 |
| Rubber rings for jointing P.S.C. Pipes | 5382 – 1985 |
| Rubber rings for jointing AC pipes with AC couplings | 10292 – 1985 |
| Pig lead (caulking lead) | 782 – 1978 |
| Hemp yarn | 6587 – 1966 |
| Rubber insertion to be used in jointing CIDF Pipes | 638 – 1979 |
| Bolts & Nuts to be used in jointing CIDF Pipes | 1363 – 1967 |
| Un-plasticized PVC Pipes for potable water supplies | 4985 – 2000 |
| Injection moulded PVC socket fittings with Solvent cement joints for water supplies | 7834 – 1987 (Part I to 8) |
| Fabricated PVC fittings for potable water supplies | 10124 – 1988 (Part I to 13) |
| Methods of test for un-plasticized PVC pipes for potable water supplies | 12235 – 1986 (Part I to 11) |
| Sluice valves for water works purposes (50 to 300mm Dia size) | 780 – 1984 |
| Sluice valves for water works purposes 300 to 1200mm Dia size) | 2906 – 1984 |
| Surface boxes for sluice valves | 3950 – 1979 |
| Manhole covers for sluice valves | 1726 – 1974 |
| Laying of Asbestos Cement Pressures Pipes | 6530 – 1972 |
| Laying of concrete Pipes | 783 – 1985 |
| Laying of Cast – Iron Pipes | 3114 – 1985 |
| Laying of PSC Pipes | 126 of APSS & 783 – 1985 |
| Laying of DI Pipes | 12288 – 1987 |
| Laying and Jointing of un-plasticized PVC Pipes | 7634 – 1975 (Part 3) |
| Batch type concrete mixer | 1791 – 1968 |
| Sheep foot roller | 4616 – 1968 |
| Safety code for excavation works | 3764 – 1966 |
| Safety code for scaffolds and ladders Part I – Scaffolders Part II – Ladders | 3696 – 1966 (Part I) 3696 – 1966 (Part II) |
| Safety code for piling and other deep foundations | 5121 – 1969 |
| Safety code for working with construction machinery | 7293 – 1974 |
| Odisha Building Practice | Volume – I Volume – II |
| Government of India Manual on Water Supply and Treatment | May 1999 (Revised) |
| Gravel for packing | 4091 – 1967 |
| Hard drawn steel wire | 1785 – 1983 (Part I and II) |

| | |
|---|--------------------------------|
| Structural Steel | 226 – 1975 |
| Hand rolled mils steel for concrete | 1139 – 1966 |
| Hard drawn Steel Wire | 1566 – 1982 |
| American Society for Testing of materials | |
| British Standard | 2494 – 1955Part I |
| Welding Electrodes | 814 – 1970 |
| Steel Sheets | 225 – 1975 |
| Guniting | 7322 – 1994 |
| Welding Joints | 3589 – 1966 and 2041 – 1962 |
| Tensile Test | 223 – 1950 |
| Mechanical and Electrical works | |
| Turbine Pump | 1710 – 1972 |
| Submersible Pump | 8030 – 1976 |
| Submersible Motor | 9283 – 1979 |
| Earthing | 3043 – 1966 |
| Transformer | 1180 – 1964 |
| Generator | 2253 – 4722 |
| HDPE Pipes | 4984 - 1995 |
| UPVC pipes | 15328-2003 |
| Laying of MS pipes | 5822-2000 |